

LP4024.539-US-SYM-LE-700-740-ONOFF-UNI-C1-HM1

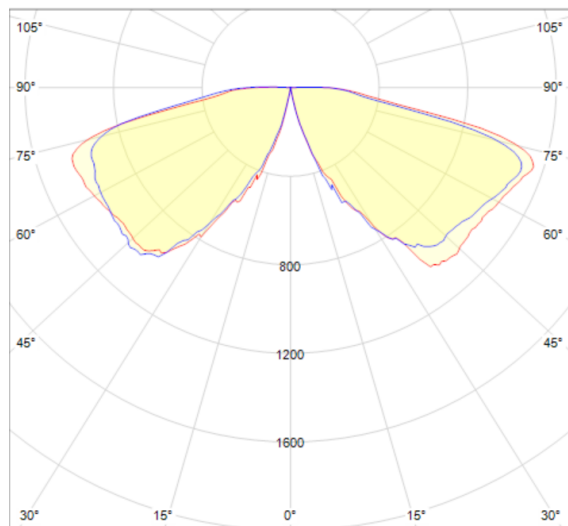
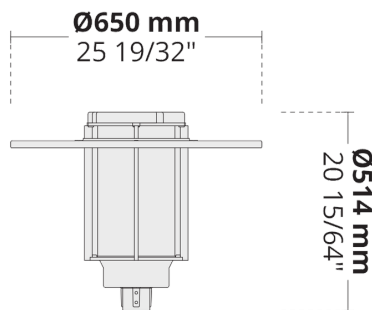

[SYM-LE]

Symmetric, 360°,
Special effect:
Leaf

Configuration

Light distribution	[SYM-LE]
Nominal lumens flux	6480 lm
Power	48 W (700 mA)
Delivered lumens flux	4080 lm
Rated input power	52 W
Color temperature	4000 K CRI 70
Lamp	24 LED
MacAdam Ellipse	3 SDCM
Energy efficiency class	A+
BUG rating	B1-U0-G2

Options







Control	ONOFF
Input voltage	120-277V 50/60Hz
Insulation class	Class I
Product colors	

Technical information

Mounting	Direct pole or side bracket mountable. Tenon: Ø2 1/4" x 4"
Housing	Corrosion resistant aluminum housing
Finishing	Electrostatic powder coating
Fasteners	Stainless steel (grade 304)
Gasket	EPDM gasket (Shore A 20-25)
Lens / Reflector	PMMA lens with high optical efficiency
Glass / Diffusor	Tempered safety glass
Impact protection	IK07
Ingress protection	IP65
Wind catching area (EPA)	4.2 ft ²
LED module	High power LEDs on metal-core PCB
Driver	Internal LED driver
Driver surge protection	1/1 kV
Power factor	> 0.99
Through wiring	Single cable entry
Cable	19 11/16" of flexible cable

Project name		Type		Quantity	
Date		Note			

LP4024.539-US-SYM-LE-700-740-ONOFF-UNI-C1-HM1

Light distribution	Drive current (Power)	Color temperature	Control	Input voltage
SYM-LE Symmetric, 360°, Special effect: Leaf	700 48 W (700 mA)	740 4000 K CRI 70	ONOFF On/Off	UNI 120-277V 50/60Hz
ASYM-LE Asymmetric, 180°, Special effect: Leaf	700 24 W (700 mA)	830 3000 K CRI 80	DIM 1-10V	
Insulation class	Product colors	Extras		
C1 Class I	HM1  Black (Textured)	External surge protection		
	HM2  Dark gray (Textured)	SP10-US 10 kV		
	HM3  Anthracite gray (Textured)	Finishing option		
	HM4  Light gray (Textured)	DC Double coating		
	HM5  White (Textured)	Light output		
	HM6  Bronze (Textured)	CLO Constant light output		
	CC  Custom Colour (Please specify RAL code)			