

PLAN AT PARAPET
SLOPED FACE PARAPET

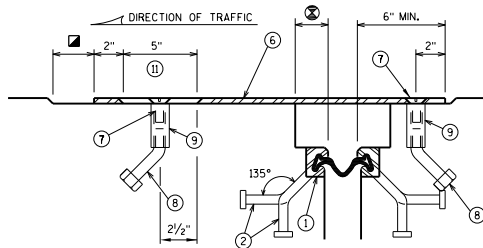

SECTION C-C

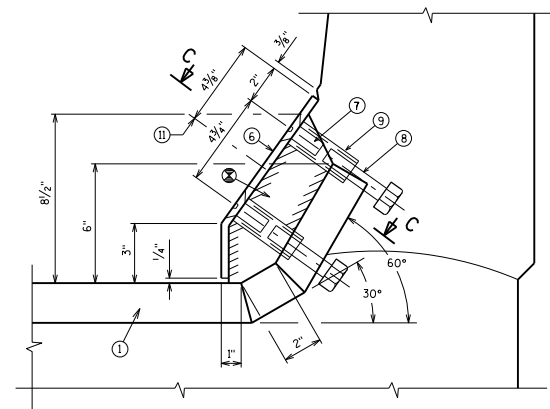

SECTION A-A
SLOPED FACE PARAPET

(6) GALVANIZED PLATE $\frac{3}{8}$ " x $10\frac{1}{2}$ " x (2'-2" LONG FOR SKEWS TO 45° AND 3'-0" LONG FOR SKEWS \geq 45°) WITH HOLES FOR NO. 7. BEND AS SHOWN.

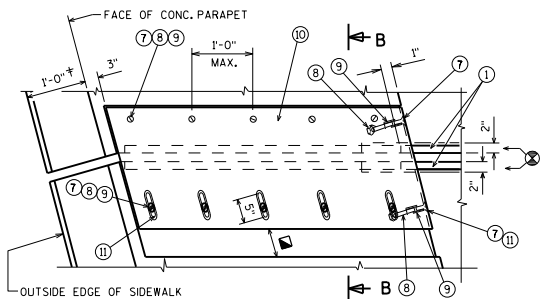

PLAN AT SIDEWALK

† 1'-2" WHEN "VERTICAL FACE PARAPET TYPE 'TX' IS USED

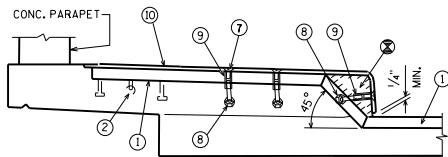

SECTION AT SIDEWALK

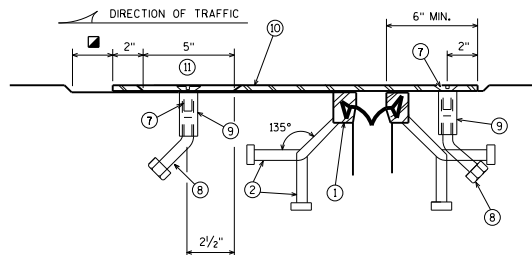

SECTION B-B

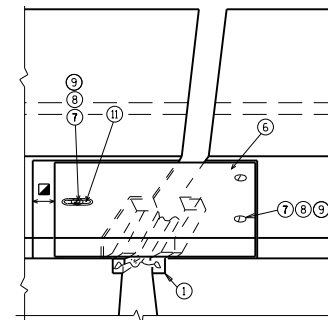

VIEW OF PARAPET PLATES FROM ROADWAY
SLOPED FACE PARAPET

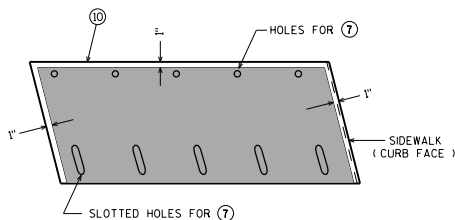

PLAN OF SIDEWALK COVER PLATE WITH SLIP-RESISTANT SURFACE

PLACE SLIP-RESISTANT SURFACE ON TOP WALKING SURFACE IN SHADED AREA ONLY (NOT ON CURB FACE).

DESIGNER NOTES

FOR JOINT REPLACEMENT PROJECTS, JOINT SHALL BE DETAILED TO MATCH ORIGINAL CONFIGURATION (STRAIGHT OR KINKED) IN ORDER TO REDUCE SUBSTRUCTURE MODIFICATIONS REQUIRED.

PLAN DETAILS SHALL REMOVE ENOUGH PARAPET Laterally, AND FULL HEIGHT, TO ENSURE DURABILITY OF THE JOINT REPLACEMENT.

- (X) BLOCK OUT CONCRETE 2" EACH SIDE OF JOINT OPENING
- (Z) JOINT OPENING DIM. ALONG SKEW PLUS $\frac{1}{2}$ "

APPROVED SLIP-RESISTANT APPLIED SURFACES FOR STEEL PLATES		
PRODUCT	MANUFACTURER	CONTACT AT
SLIPNOT GRADE 2, STEEL	W. S. MOLNAR COMPANY	1-800-SLIPNOT
ALGRIP, STEEL	ROSS TECHNOLOGY CORP.	1-800-345-8170

STRIP SEAL COVER PLATES SLOPED FACE PARA./SDWK.



APPROVED: Bill Oliva DATE: 1-20