

SPREAD FOOTING SHOWN, OTHER FOUNDATION TYPES POSSIBLE. (FOR PEDESTAL WALL, PILE AND BASE SLAB FOUNDATIONS, "SEE OPTIONAL DETAIL 2")

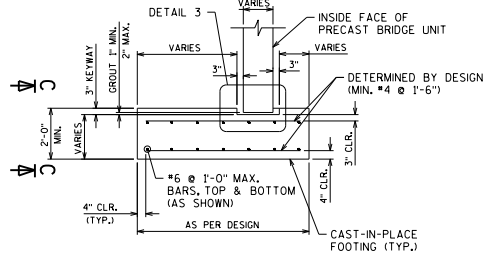

DETAIL 2

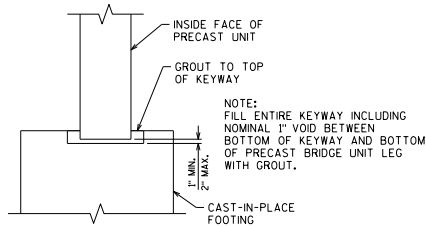

DETAIL 3

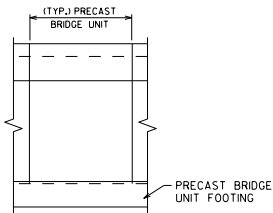

SECTION C

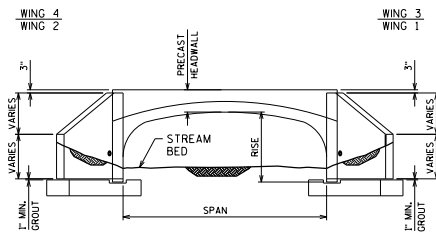

TYPICAL END ELEVATION

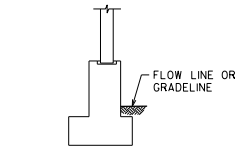

OPTIONAL DETAIL 2
IF PEDESTAL IS REQUIRED

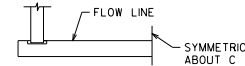

OPTIONAL DETAIL 2
IF BASE SLAB IS REQUIRED

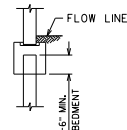

OPTIONAL DETAIL 2
IF PILES ARE REQUIRED

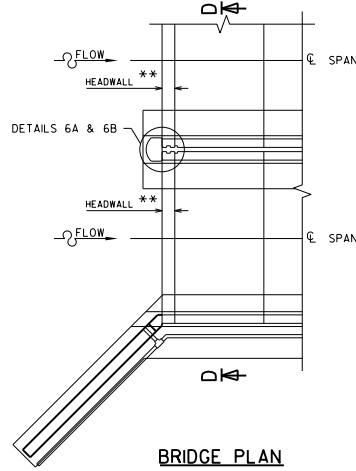

BRIDGE PLAN

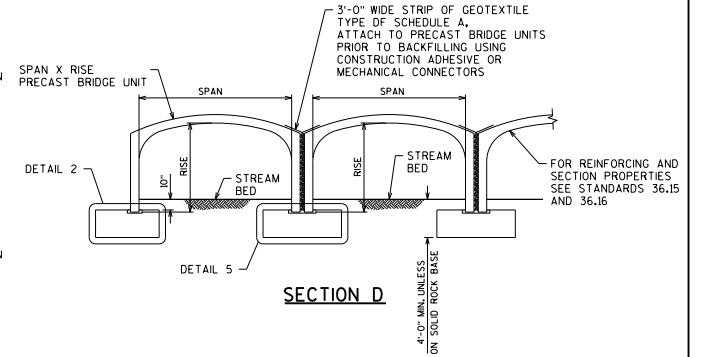

SECTION D

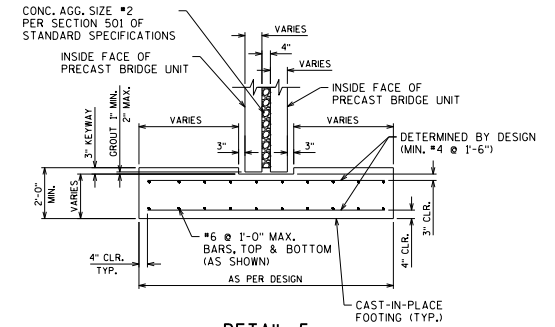

DETAIL 5

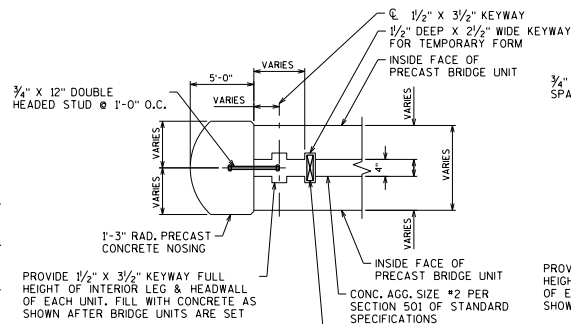

DETAIL 6A

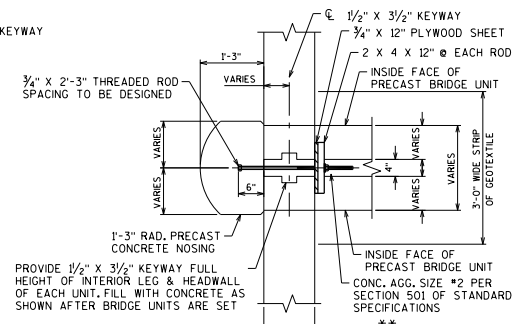

DETAIL 6B

NOTES:
**SEE STANDARDS 36.13 AND 36.14 FOR HEADWALL DETAILS AND FEASIBILITY GUIDELINES

PRECAST THREE-SIDED BOX CULVERT DETAILS



APPROVED: Bill Oliva DATE: 7-18