

W1 STANDARD

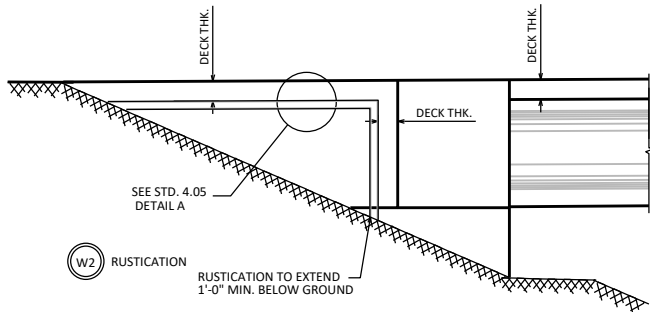

W2 RUSTICATION

RUSTICATION TO EXTEND 1'-0" MIN. BELOW GROUND

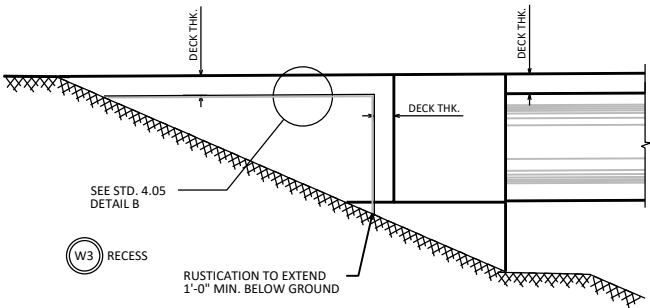

W3 RECESS

RUSTICATION TO EXTEND 1'-0" MIN. BELOW GROUND

**WING OPTIONS**

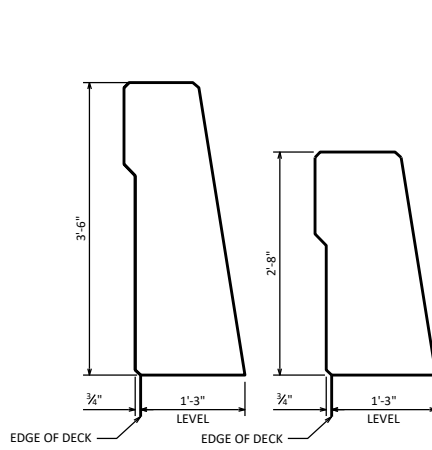

R1 STANDARD

SEE STD. 30.32 'SINGLE SLOPE PARAPET 425S' OR STD. 30.30 'SINGLE SLOPE PARAPET 325S' FOR DETAILS

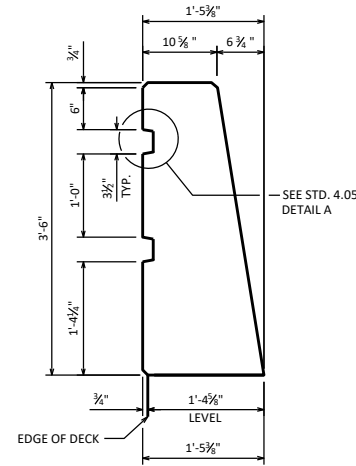

R2

DOUBLE RUSTICATION LINES MODIFIED 'SINGLE SLOPE PARAPET 425S' (AREA = 4.01 SF, WEIGHT = 602 LB/FT.)

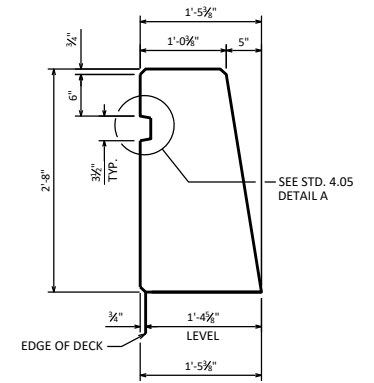

R2

SINGLE RUSTICATION LINES MODIFIED 'SINGLE SLOPE PARAPET 325S' (AREA = 3.25 SF, WEIGHT = 488 LB/FT.)

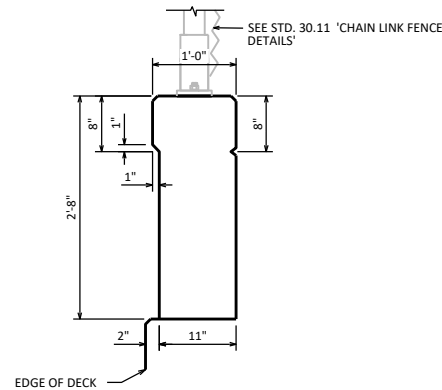

R3 STANDARD

SEE STD. 30.07 'VERTICAL FACE PARAPET 'A'' FOR DETAILS

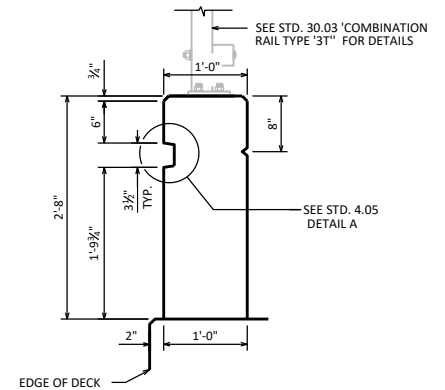

R4 SINGLE RUSTICATION LINES

MODIFIED 'VERTICAL FACE PARAPET 'A'' (AREA = 2.63 SF, WEIGHT = 395 LB/FT.)

SEE STD. 30.07 'VERTICAL FACE PARAPET 'A'' FOR DETAILS

**PARAPET OPTIONS**

**DESIGNER NOTES**

WINGS PARALLEL TO CENTERLINE OF ABUTMENT (ELEPHANT EAR) ARE TO BE PLAIN (TYPE I).

**WING & PARAPET AESTHETIC DETAILS**



**BUREAU OF STRUCTURES**

APPROVED: *Laura Shadewald*

DATE: 1-19