



Table of Contents

6.1 Approvals, Distribution and Work Flow5

6.2 Preliminary Plans8

 6.2.1 Structure Survey Report.....8

 6.2.2 Preliminary Layout.....9

 6.2.2.1 General.....9

 6.2.2.2 Basic Considerations.....14

 6.2.2.3 Requirements of Drawing15

 6.2.2.3.1 Plan View.....15

 6.2.2.3.2 Elevation View17

 6.2.2.3.3 Cross-Section View.....17

 6.2.2.3.4 Other Requirements.....18

 6.2.2.4 Utilities20

 6.2.3 Distribution of Exhibits.....20

 6.2.3.1 Federal Highway Administration (FHWA).....20

 6.2.3.2 Coast Guard22

 6.2.3.3 Regions22

 6.2.3.4 Utilities22

 6.2.3.5 Other Agencies.....22

6.3 Final Plans23

 6.3.1 General Requirements23

 6.3.1.1 Drawing Size23

 6.3.1.2 Scale.....23

 6.3.1.3 Line Thickness.....23

 6.3.1.4 Lettering and Dimensions.....23

 6.3.1.5 Notes23

 6.3.1.6 Standard Insert Drawings24

 6.3.1.7 Abbreviations.....24

 6.3.1.8 Nomenclature and Definitions25

 6.3.2 Plan Sheets25

 6.3.2.1 General Plan (Sheet 1).....26

 6.3.2.1.1 Plan notes for New Bridge Construction.....28

 6.3.2.1.2 Plan Notes for Bridge Rehabilitation.....29



6.3.2.2 Subsurface Exploration30

6.3.2.3 Abutments30

6.3.2.4 Piers31

6.3.2.5 Superstructure32

 6.3.2.5.1 All Structures.....32

 6.3.2.5.2 Steel Structures33

 6.3.2.5.3 Railing and Parapet Details34

6.3.3 Miscellaneous Information.....34

 6.3.3.1 Bill of Bars34

 6.3.3.2 Box Culverts35

 6.3.3.3 Miscellaneous Structures35

 6.3.3.4 Standard Drawings36

 6.3.3.5 Insert Sheets36

 6.3.3.6 Change Orders and Maintenance Work36

 6.3.3.7 Bench Marks.....36

6.3.4 Checking Plans36

 6.3.4.1 Items to be Destroyed When Construction is Completed (Group A)37

 6.3.4.2 Items to be Destroyed when Plans are Completed (Group B)37

6.3.5 Processing Plans.....39

6.4 Computation of Quantities40

 6.4.1 Excavation for Structures Bridges (Structure)40

 6.4.2 Backfill Granular or Backfill Structure40

 6.4.3 Concrete Masonry Bridges.....40

 6.4.4 Prestressed Girder Type I (28-Inch; 36-Inch; 36W-Inch; 45W-Inch; 54W-Inch; 72W-Inch, 82W-Inch)41

 6.4.5 Bar Steel Reinforcement HS Bridges or Bar Steel Reinforcement HS Coated Bridges41

 6.4.6 Structural Steel Carbon or Structural Steel HS41

 6.4.7 Bearing Pads Elastomeric Non-Laminated or Bearing Pads Elastomeric Laminated or Bearing Assemblies Fixed (Structure) or Bearing Assemblies Expansion (Structure)41

 6.4.8 Piling Test Treated Timber (Structure)41

 6.4.9 Piling CIP Concrete Delivered and Driven ___-Inch, Piling Steel Delivered and Driven ___ -Inch41

 6.4.10 Preboring CIP Concrete Piling or Steel Piling42

 6.4.11 Railing Steel Type (Structure) or Railing Tubular Type (Structure)42



6.4.12 Slope Paving Concrete or Slope Paving Crushed Aggregate or Slope Paving Select Crushed Material42

6.4.13 Riprap Medium, Riprap Heavy or Grouted Riprap, Riprap Light42

6.4.14 Pile Points42

6.4.15 Floordrains Type GC or Floordrains Type H42

6.4.16 Cofferdams (Structure).....42

6.4.17 Rubberized Membrane Waterproofing42

6.4.18 Expansion Device (Structure).....42

6.4.19 Electrical Work42

6.4.20 Conduit Rigid Metallic __-Inch or Conduit Rigid Nonmetallic Schedule 40 -Inch43

6.4.21 Preparation Decks Type 1 or Preparation Decks Type 243

6.4.22 Cleaning Decks43

6.4.23 Joint Repair43

6.4.24 Concrete Surface Repair43

6.4.25 Full-Depth Deck Repair43

6.4.26 Concrete Masonry Overlay Decks.....43

6.4.27 Removing Old Structure STA. XX + XX.XX43

6.4.28 Anchor Assemblies for Steel Plate Beam Guard.....43

6.4.29 Steel Diaphragms (Structure).....43

6.4.30 Welded Stud Shear Connectors X -Inch43

6.4.31 Concrete Masonry Seal.....44

6.4.32 Geotextile Fabric Type44

6.4.33 Masonry Anchors Type L No. Bars44

6.4.34 Piling Steel Sheet Permanent Delivered or Piling Steel Sheet Permanent Driven....44

6.4.35 Piling Steel Sheet Temporary.....44

6.4.36 Temporary Shoring.....44

6.4.37 Concrete Masonry Deck Patching.....44

6.4.38 Sawing Pavement Deck Preparation Areas44

6.4.39 Removing Bearings.....44

6.5 Production of Bridge Plans by Consultants, Regional Offices and Other Agencies.....45

6.5.1 Approvals, Distribution, and Work Flow45

6.5.2 Preliminary Plan Requirements.....46

6.5.3 Final Plan Requirements48

6.5.4 Design Aids & Specifications.....49



6.5.5 Processing Consultant Prepared Bridge Plans49

|



1. Plan View
 - a. Place a keyed construction joint near the center of the abutment if the length of the body wall exceeds 50 feet. Make the keyway as large as feasible and extend the horizontal bar steel through the joint.
 - b. Dimension wings in a direction parallel and perpendicular to the wing centerline.
 - c. Dimension angle between wing and body if that angle is different from the skew angle of the abutment.
2. Elevation
 - a. Give beam seat, wing (front face and wing tip), and footing elevations to the nearest .01 of a foot.
 - b. Give vertical dimension of wing.
3. Wing Elevation
4. Body Section

Place an optional keyed construction joint in the parapet at the bridge seat elevation if there is a parapet.
5. Wing Sections
6. Bar Steel Listing and Detail

Use the following views where necessary:

7. Pile Plan & Splice Detail
8. View Showing Limits of Excavation and Backfill
9. Special Details for Utilities
10. Drainage Details

6.3.2.4 Piers

Use as many sheets as necessary to show all details clearly. One sheet may show several piers if only the height, elevations and other minor details are different.

Give dimensions for a skewed pier to a reference line which passes through the intersection of the longitudinal structural reference line and the pier centerline. Show the skew angle. Dimension the centerline spacing of superstructure girders.

1. Plan View



Show dimensions, footings, cap steps, beam spacings and skew angle.

2. Elevation

Show dimensions and elevations. Show lengths of all columns for clarity. Give the elevation of the bottom of footings and beam seats. Refer to abutments for detailing bridge seats. Dimension all bar steel and stirrups.

3. Footing Plan

Show dimensions for pile spacing, pile numbers and reinforcing steel in footing.

4. Bar Steel Listing and Details

5. Pile Splice Detail (If different from abutment only).

6. Cross Section thru Column and Pier Cap

Detail anchor bolts between reinforcing bars to provide clearance. Long steel bridges may require more clearance. This allows an erection tolerance for the structural steel so that the bar steel is not pierced by the anchor bolts if the bearing is shifted.

6.3.2.5 Superstructure

Use as many sheets as are necessary to show all details clearly. Standard insert sheets are available to show many standard details. The title, project number, and a few basic dimensions are added to these standard sheets.

6.3.2.5.1 All Structures

1. Show the cross-section of roadway, plan view and related details, elevation of typical girder or girders, details of girders, and other details not shown on standard insert sheets. All drawings are to be fully dimensioned and show such sections and views as needed to detail the superstructure completely.

2. For girder bridges:

Show the total dead load deflections, including composite dead load (without future wearing surface) acting on the composite section, at tenth points of each span. Distribute the composite dead load evenly to all girders and provide one deflection value for a typical interior girder. Chapter 17 – Superstructure-General illustrates three load cases for exterior girder design with raised sidewalks, cases that provide a conservative envelope to ensure adequate girder capacity. However, the above composite dead load distribution should be used for deflection purposes. For prestressed concrete girders, the dead load deflection reported does not include the weight of the girder. See Chapter 24 – Steel Girder Structures for camber and blocking, top of steel elevation and deflection reporting criteria.

A separate deflection value for interior and exterior girders *may* be provided if the difference, accounting for load transfer between girders, warrants multiple values. A



weighted distribution of composite dead load could be used for deflection purposes *only*. For example, an extremely large composite load over the exterior girder could be distributed as 40-30-30 percent to the exterior and first two interior girders respectively. Use good engineering judgment to determine whether to provide separate deflection values for individual girder lines. In general, this is not necessary.

For slab bridges:

Provide camber values at the tenth points of all spans. The camber is based on 3 times the deflection of the slab, only. For multi-span bridges, the deflection calculations are based on a continuous span structure since the falsework supports the bridge until the concrete slab has cured.

Deflection and camber values are to be reported to the nearest 0.1 inch.

3. For girder structures, provide finished grade top of deck elevations for each girder line at the tenth points of all spans. Show the top of deck elevations at the outside edge of deck at tenth points. If staged construction, include tenth point elevations along the construction joint. For slab structures, provide the finished grade elevations at the centerline and/or crown and edge of slab at tenth points.
4. Decks of uniform thickness are used on all girders. Variations in thickness are achieved by haunching the deck over each girder. Haunches are formed off the top of the top flange. See the standards for details. In general the minimum haunch depth along the edge of girder is to be 1 1/4" although 2" is recommended to allow for construction tolerances. Haunch depth is the distance from the bottom of the concrete deck to the top of the top flange.
5. Provide a paving notch at each end of all structures for rigid approach pavements. See standard for details.
6. If the structure contains conduit for a deck lighting system, place the conduit in the concrete parapet. Place expansion devices on conduit which passes through structure expansion joints.
7. Show the bar steel reinforcement in the slab, curb, and sidewalk with the transverse spacing and all bars labeled. Show the direction and amount of roadway crown.
8. On bridges with a median curb and left turn lane, water may be trapped at the curb due to the grade slope and crown slope. If this is the case, make the cross slope flat to minimize the problem. Existing pavers cannot adjust to a variable crown line.
9. On structures with modular joints consider cover plates for the back of parapets when aesthetics are a consideration.

6.3.2.5.2 Steel Structures

1. Show the diaphragm connections on steel girders. Show the spacing of rail posts on the plan view.



2. Show a steel framing plan for all steel girders. Show the spacing of diaphragms.
3. On the elevation view of steel girders show dimension, material required, field and shop splice locations, stiffener spacing, shear connector spacing, and any other information necessary to construct the girder. In additional views show the field splice details and any other detail that is necessary.
4. Show the size and location of all weld types with the proper symbols except for butt welds. Requirements for butt welds are covered by A.W.S. Specifications.
5. See Chapter 24 – Steel Girder Structures for camber and blocking, top of steel elevation and deflection reporting criteria.
6. Existing flange and web sizes should be shown to facilitate the sizing of bolts on Rehabilitation Plans.

6.3.2.5.3 Railing and Parapet Details

Standard drawings are maintained by the Structures Development Section showing railing and parapet details. Add the details and dimensions to these drawings that are unique to the structure being detailed. Compute the length along the slope of grade line rather than the horizontal dimension.

6.3.3 Miscellaneous Information

6.3.3.1 Bill of Bars

Show a complete bill of bar steel reinforcement for each unit of the structure. Place this bill on the sheet to which the bars pertain. If the abutments or piers are similar, only one bar list is needed for each type of unit.

Give each bar or group of bars a different mark if they vary in size, length, or location in a unit. Each bar list is to show the mark, number of bars, length, location and detail for each bar. Give bar lengths to the nearest 1" and segment lengths of bent bars to the nearest 1/2". Show all bar bends and hooks in detail.

Identify all bars with a letter indicating the unit in which the bar is placed - A for abutment, P for pier, S for superstructure. Where units are multiple, each unit should have a different letter. Next use a one or two digit number to sequentially number the bars in a unit. P1008 indicates bar number 08 is a size number 10 bar located in a Pier.

Use a Bar Series Table where a number of bars the same size and spacing vary in length is a uniform progression. Use only one mark for all these bars and put the average length in the table.

Refer to the Standard drawings in Chapter 9.0 for more information on reinforcing bars such as minimum bend diameter, splice lengths, bar supports, etc.



When a bridge is constructed in stages, show the bar quantities for each stage. This helps the contractor with storage and retrieval during construction.

6.3.3.2 Box Culverts

Detail plans for box culverts are to be fully dimensioned and have sectional drawings needed to detail the structure completely. The following items are to be shown when necessary:

1. Plan View
2. Longitudinal section
3. Section thru box
4. Wing elevations
5. Section thru wings
6. Section thru cutoff wall
7. Vertical construction joint
8. Bar steel clearance details
9. Header details
10. North point, Bench mark, Quantities
11. Bill of bars, Bar details
12. General notes, List of drawings, Rip rap layout
13. Inlet nose detail on multiple cell boxes
14. Corner details

Bid items are excavation, concrete masonry, bar steel and rip rap. Non bid items are membrane waterproofing, filler and expansion bolts. In lieu of showing a contour map, show profile grade lines as described for Subsurface Exploration sheet.

See the standard details for box culverts for the requirements on vertical construction joints, apron and cutoff walls, longitudinal construction joints, and optional construction joints.

Show name plate location on plan view and on wing detail.

6.3.3.3 Miscellaneous Structures

Detail plans for other structures such as retaining walls, sign bridges, pedestrian bridges, and erosion control structures are to be detailed with the same requirements as previously mentioned.



6.3.3.4 Standard Drawings

Standard drawings are maintained and furnished by the Structures Development Section. These drawings show the common types of details required on the contract plans.

6.3.3.5 Insert Sheets

These sheets are maintained by the Structures Development Section and are used in the contract plans to show standard details.

6.3.3.6 Change Orders and Maintenance Work

These plans are drawn on full size sheets.

6.3.3.7 Bench Marks

Bench mark caps are shown on all bridges and larger culverts. Locate the caps on a horizontal surface flush with the concrete. Show the location in close proximity to the Name Plate.

6.3.4 Checking Plans

Upon completion of the design and drafting of plans for a structure, the final plans are usually checked by one person. Dividing plans checking between two or more Checkers for any one structure leads to errors many times. The plans are checked for compliance with the approved preliminary drawing, design, sufficiency and accuracy of details, dimensions, elevations, and quantities. Generally the information shown on the preliminary plan is to be used on the final plans. Revisions may be made to footing sizes and elevations, pile lengths, dimensions, girder spacing, column shapes, and other details not determined at the preliminary stage. Any major changes from the preliminary plan are to be approved by the Chief Bridge Design Engineer.

Give special attention to unique details and unusual construction problems. Take nothing for granted on the plans.

The Checkers check the final plans against the Engineer's design and sketches to be sure all information is shown correctly. The Engineer prepares all sketches and notations not covered by standard drawings. A good Checker checks what is shown and noted on the plan and also checks to see if any essential details, dimensions, or notation have been omitted. Check the final plan Bid Items for conformity with those scheduled in the WisDOT Standard Specifications for Highway and Structure Construction.

The Checker makes an independent Bill of Bars list to be sure the detailer has not omitted any bars when checking the quantity of bar steel.

Avoid making minor revisions in details or dimensions that have very little effect on cost, appearance, or adequacy of the completed structure. Check grade and bridge seat elevations and all dimensions to the required tolerances. The Checkers make all corrections, revisions, and notations on a print of the plan and return it to the Plan Preparer. The Plan



Preparer back checks all marks made by the checker before changing. Any disagreements are resolved with the supervisor.

Common complaints received from field people are dimension errors, small details crowded on a drawing, lettering is too small, and reinforcing bar length or quantity errors.

After the plans are completed, the items in the survey folder are separated into the following groups by the Structures Design Unit Supervisor or plans checker:

6.3.4.1 Items to be Destroyed When Construction is Completed (Group A)

1. Miscellaneous correspondence and Transmittal letters
2. Preliminary drawings and computations
3. Prints of soil borings and plan profile sheets
4. Quantity computations and bill of bars
5. Shop steel quantity computations*
6. Design checker's computations
7. Designer Computations and computer runs of non-complex structures on non state maintained structures.
8. Layout sheets
9. Elevation runs and bridge geometrics
10. *Falsework plans*
11. Miscellaneous Test Report
12. Photographs of Bridge Rehabs

* These items are added to the packet during construction.

6.3.4.2 Items to be Destroyed when Plans are Completed (Group B)

1. All "void" material
2. All copies except one of preliminary drawings
3. Extra copies of plan and profile sheets
4. Preliminary computer design runs

Items in Group A should be placed together and labeled. Items in Group B should be discarded.



The following items are part of the Data Management System for Structures. The location is shown for all items that need to be completed in order to properly manage the Structure data either by Structures Design personnel for in-house projects or consultants for their designs. Data for filing that is generated outside the Bureau of Structures should be sent to the Structures Development Section.

1. Structure Inventory Form (Available on DOTNET) - New Bridge File – Data for this form is completed by the preliminary designer and plans checker. It is submitted to the Structures Development Section for entry into the File.
2. Load Rating Input File - Permits File - The designers submit an electronic copy of the input data for load rating the structure to the Structures Development Section. It is located for internal use at //H32751/rating.
3. Designer Computations and Inventory Superstructure Design Run (Substructure computer runs as determined by the Engineer) - **HSI – The designers record design, inventory, operating ratings and maximum vehicle weights on the plans and place into the scanned folder.
4. Pile Driving Reports - HSI - Structures Development Section scans reports into HSI.
5. Shop Drawings for Steel Bridges, Sign Bridges, Prestressed Girders, High Mast Poles, Retaining Walls, Floor Drains, Railings and all Steel Joints - HSI - Metals Fabrication & Inspection Unit or other source sends to the Structures Development Section to scan all data into HSI.
6. Mill Tests, Heat Numbers and Shop Inspection Reports for all Steel Main Members - HSI - Metals Fabrication & Inspection Unit sends electronic files data into HSI.
7. Hydraulic and Scour Computations, Contour Maps and Site Report - HSI - Data is placed into scanned folder by Preliminary Structures & Hydraulics Unit.
8. Subsurface Exploration Report - HSI - Report is placed into scanned folder by Preliminary Structures & Hydraulics Unit or electronic copies are loaded from Geotechnical files.
9. Structure Survey Report - HSI - Report is placed into scanned folder by Preliminary Structures & Hydraulics Unit.
10. As Built Plans - HSI - At bid letting, the printers place a digital image of plans in a computer folder and send to the Structures Development Section where the plan sheets are labeled and placed in HSI. As Built plans will replace bid letting plans when available and will be scanned by the Structures Development Section.
11. Inspection Reports - New Bridge File - The Structures Maintenance Section loads a copy of the following Inspection Reports into the New Bridge File.



Table of Contents

9.1 General2

9.2 Concrete3

9.3 Reinforcement Bars4

 9.3.1 Development Length and Lap Splices for Deformed Bars5

 9.3.2 Bends and Hooks for Deformed Bars.....6

 9.3.3 Bill of Bars7

 9.3.4 Bar Series.....7

9.4 Steel9

9.5 Miscellaneous Metals.....11

9.6 Timber12

9.7 Miscellaneous Materials.....13

9.8 Painting15

9.9 Bar Tables and Figures.....17



9.1 General

The *Wisconsin Standard Specifications for Highway and Structure Construction* (hereafter referred to as *Standard Specifications*) contains references to *ASTM Specifications* or *AASHTO Material Specifications* which provide required properties and testing standards for materials used in highway structures. The service life of a structure is dependent upon the quality of the materials used in its construction as well as the method of construction. This chapter highlights applications of materials for highway structures and their properties.

In cases where proprietary products are experimentally specified, special provisions are written which provide material properties and installation procedures. Manufacturer's recommendations for materials, preparation and their assistance during installation may also be specified.

Materials that are proposed for incorporation into highway structure projects performed under the jurisdiction of the Wisconsin Department of Transportation (WisDOT) may be approved or accepted by a variety of procedures:

- Laboratory testing of materials that are submitted or samples randomly selected.
- Inspection and/or testing at the source of fabrication or manufacture.
- Inspection and/or testing in the field by WisDOT regional personnel.
- Manufacturer's certificate of compliance and/or manufacturer's certified report of test or analysis, either as sole documentation for acceptance or as supplemental documentation.
- Inspection, evaluation and testing in the normal course of project administration of material specifications.
- Some products are on approved lists or from fabricators, manufacturers, and certified sources approved by WisDOT. Lists of approved suppliers, products, and certified sources are located at www.atwoodsyste.ms.com/materials.

The *Wisconsin Construction and Materials Manual* (CMM) contains a description of procedures for material testing and acceptance requirements in Chapter 45, Section 25. Materials, unless otherwise permitted by the specifications, cannot be incorporated in the project until tested and approved by the proper authority.



retaining walls, hooks may be the only practical solution because of the concrete depth available for developing the capacity of the bars.

Fabricators stock all bar sizes in 60 foot lengths. For ease of handling, the detailed length for #3 and #4 bars is limited to 45 feet. Longer bars may be used for these bar sizes at the discretion of the designer, when larger quantities are required for the structure. All other bar sizes are detailed to a length not to exceed 60 feet, except for vertical bars. Bars placed in a vertical position are limited to lengths of approximately 30 feet. The location of mandatory horizontal construction joints in pier shafts or columns will generally determine the length of vertical bars in piers. All bars are detailed to the nearest inch.

The number of bars in a bundle shall not exceed four, except in flexural members the bars larger than #11 shall not exceed two in any one bundle. Individual bars in a bundle, cut off within the span of a member, shall be terminated at different points with at least a 40-bar diameter stagger. Where spacing limitations are based on bar size, bundled bars shall be treated as a single bar of a diameter derived from the equivalent total area **LRFD [5.10.3.1.5]**.

9.3.1 Development Length and Lap Splices for Deformed Bars

[Table 9.9-1](#) and [Table 9.9-2](#) provide the development length, l_d , for straight bars and the required lap length of spliced tension bars according to **LRFD [5.11.2.1, 5.11.5.3]**. The basic development length, l_{db} , is a function of bar area, A_b , bar diameter, d_b , concrete strength, f'_c and yield strength of reinforcement, f_y . The basic development length is multiplied by applicable modification factors to produce the required development length, l_d . The lap lengths for spliced tension bars are equal to a factor multiplied times the development length, l_d . The factor applied depends on the classification of the splice; Class A, B or C. The class selected is a function of the numbers of bars spliced at a given location and the ratio of the area of reinforcement provided to the area required. The values for development length (required embedment) are equal to Class “A” splice lengths shown in these tables. [Table 9.9-1](#) gives the development lengths and required lap lengths for a concrete compressive strength of $f'_c = 3.5$ ksi and a reinforcement yield strength of $f_y = 60$ ksi. [Table 9.9-2](#) gives these same lengths for a concrete compressive strength of $f'_c = 4$ ksi and a reinforcement yield strength of $f_y = 60$ ksi. In tensile stress zones the maximum allowable change in bar size at a lap is three bar sizes. The spacing of lap splice reinforcement is provided in **LRFD [5.10.3.1.4]**, but values on Standards should be used where provided.

The development length of individual bars within a bundle, shall be that for the individual bar, increased by 20% for a three-bar bundle and by 33% for a four-bar bundle **LRFD [5.11.2.3]**. For determining the modification factors specified in **LRFD [5.11.2.1.2, 5.11.2.1.3]**, a unit of bundled bars shall be treated as a single bar of a diameter determined from the equivalent total area.

Lap splices within bundles shall be as specified in **LRFD [5.11.2.3]**. Individual bar splices within a bundle shall not overlap. Entire bundles shall not be lap spliced **LRFD [5.11.5.2.1]**.

Hook and embedment requirements for transverse (shear) reinforcement are stated in **LRFD [5.11.2.6.2]**. The lap length for pairs of U-stirrups or ties that are placed to form a closed unit shall be considered properly anchored and spliced where lengths of laps are not less than



1.7 ℓ_d **LRFD [5.11.2.6.4]**. In members not less than 18 inches deep, the length of the stirrup leg for anchoring closed stirrup splices is described in **LRFD [5.11.2.6.4]**.

The Bureau of Structures interprets the lap length to be used for temperature and distribution reinforcement to be a Class “A” splice (using top or others, as appropriate).

The required development length, ℓ_{dh} , for bars in tension terminating in a standard hook is detailed in **LRFD [5.11.2.4]**. This length increases with the bar size. The basic development length, ℓ_{hb} , for a hooked bar is a function of bar diameter, d_b , and concrete strength, f'_c . The basic development length is multiplied by applicable modification factors to produce the required development length, ℓ_{dh} .

Embedment depth is increased for dowel bars (with hooked ends) that run from column or retaining wall into the footing, if the hook does not rest on top of the bar steel mat in the bottom of the footing. This is a construction detail which is the preferred method for anchoring these bars before the concrete is placed.

Dowel bars are used as tensile reinforcement to tie columns or retaining walls to their footings. The amount of bar steel can be reduced by varying the dowel bar lengths projecting above the footing, so that only half the bars are spliced in the same plane. This is a consideration for long retaining walls and for some columns. This allows a Class “B” splice to be used, as opposed to a Class “C” splice where equal length dowel bars are used and all bars are spliced in the same plane.

The length of lap, ℓ_c , for splices in compression is provided in **LRFD [5.11.5.5.1]**.

9.3.2 Bends and Hooks for Deformed Bars

[Figure 9.9-1](#) shows standard hook and bend details for development of longitudinal tension reinforcement. [Figure 9.9-2](#) shows standard hook and bend details for transverse reinforcement (stirrups and ties). Dimensions for the bending details are shown as out to out of bar, as stated in the *Standard Specifications* Section 505.3.2. The diameter of a bend, measured on the inside of the bar for a standard bend is specified in **LRFD [5.10.2.3]**. Where a larger bend radius is required (non-standard bend) show the inside bend radius on the bar detail. When computing total bar lengths account for the accumulation in length in the bends. Use the figures mentioned above to account for accumulation in length for standard hooks and bends. One leg of bent bars is not dimensioned so that the tolerance for an error in the length due to bending is placed there. Fabrication tolerances for bent bars are specified in the *Concrete Reinforcing Steel Institute (CRSI) Manual of Standard Practices* or the *American Concrete Institute (ACI) Detailing Manual* as stated in Section 505.2.1 of the *Standard Specifications*.

[Figure 9.3-1](#) shows typical detailing procedures for bars with bends.



Table of Contents

11.1 General4

 11.1.1 Overall Design Process.....4

 11.1.2 Foundation Type Selection.....4

 11.1.3 Cofferdams.....6

 11.1.4 Vibration Concerns.....6

11.2 Shallow Foundations.....7

 11.2.1 General7

 11.2.2 Footing Design Considerations7

 11.2.2.1 Minimum Footing Depth7

 11.2.2.1.1 Scour Vulnerability8

 11.2.2.1.2 Frost Protection.....8

 11.2.2.1.3 Unsuitable Ground Conditions9

 11.2.2.2 Tolerable Movement of Substructures Founded on Shallow foundations9

 11.2.2.3 Location of Ground Water Table10

 11.2.2.4 Sloping Ground Surface10

 11.2.3 Settlement Analysis.....10

 11.2.4 Overall Stability11

 11.2.5 Footings on Engineered Fills.....12

 11.2.6 Construction Considerations13

11.3 Deep Foundations.....14

 11.3.1 Driven Piles14

 11.3.1.1 Conditions Involving Short Pile Lengths14

 11.3.1.2 Pile Spacing.....15

 11.3.1.3 Battered Piles15

 11.3.1.4 Corrosion Loss16

 11.3.1.5 Pile Points.....16

 11.3.1.6 Preboring.....17

 11.3.1.7 Seating17

 11.3.1.8 Pile Embedment in Footings.....17

 11.3.1.9 Pile-Supported Footing Depth18

 11.3.1.10 Splices18

 11.3.1.11 Painting.....18



- 11.3.1.12 Selection of Pile Types 18
 - 11.3.1.12.1 Timber Piles 19
 - 11.3.1.12.2 Concrete Piles 19
 - 11.3.1.12.2.1 Driven Cast-In-Place Concrete Piles.....20
 - 11.3.1.12.2.2 Precast Concrete Piles.....22
 - 11.3.1.12.3 Steel Piles 22
 - 11.3.1.12.3.1 H-Piles.....23
 - 11.3.1.12.3.2 Pipe Piles24
 - 11.3.1.12.3.3 Oil Field Piles24
 - 11.3.1.12.4 Pile Bents.....25
- 11.3.1.13 Tolerable Movement of Substructures Founded on Driven Piles25
- 11.3.1.14 Resistance Factors25
- 11.3.1.15 Bearing Resistance27
 - 11.3.1.15.1 Shaft Resistance.....29
 - 11.3.1.15.2 Point Resistance32
 - 11.3.1.15.3 Group Capacity33
- 11.3.1.16 Lateral Load Resistance33
- 11.3.1.17 Other Design Considerations34
 - 11.3.1.17.1 Downdrag Load34
 - 11.3.1.17.2 Uplift Resistance35
 - 11.3.1.17.3 Pile Setup and Relaxation.....35
 - 11.3.1.17.4 Drivability Analysis36
 - 11.3.1.17.5 Scour39
 - 11.3.1.17.6 Typical Pile Resistance Values.....39
- 11.3.1.18 Construction Considerations41
 - 11.3.1.18.1 Pile Hammers42
 - 11.3.1.18.2 Driving Formulas.....43
 - 11.3.1.18.3 Field Testing44
 - 11.3.1.18.3.1 Installation of Test Piles45
 - 11.3.1.18.3.2 Static Load Tests45
- 11.3.2 Drilled Shafts46
 - 11.3.2.1 General.....46
 - 11.3.2.2 Resistance Factors47
 - 11.3.2.3 Bearing Resistance49



11.3.2.3.1 Shaft Resistance49

11.3.2.3.2 Point Resistance50

11.3.2.3.3 Group Capacity50

11.3.2.4 Lateral Load Resistance50

11.3.2.5 Other Considerations.....50

11.3.3 Micropiles51

 11.3.3.1 General.....51

 11.3.3.2 Design Guidance51

11.3.4 Augered Cast-In-Place Piles51

 11.3.4.1 General.....51

 11.3.4.2 Design Guidance52

11.4 References.....53

11.5 Design Examples55



11.1 General

11.1.1 Overall Design Process

The overall foundation support design process requires an iterative collaboration to provide cost-effective constructible substructures. Input is required from multiple disciplines including, but not limited to, structural and geotechnical design. For a typical bridge design, the following four steps are required (see 6.2):

1. Structure Survey Report (SSR) – This design step results in a very preliminary evaluation of the structure type and approximate location of substructure units, including a preliminary layout plan.
2. Site Investigation Report – Based on the Structure Survey Report, a site investigation is required, including test borings to determine foundation requirements. A hydraulic analysis is also performed at this time, if required, to assess scour potential and maximum scour depth. The Site Investigation Report and Subsurface Exploration Drawing are used to identify known constraints that would affect the foundations in regard to type, location or size and includes foundation recommendations to support detailed structural design. Certain structure sites/types may require the preliminary structure plans (Step 3) prior to initiating the geotechnical site investigation. One example of this is a multi-span structure over water. See 6.2 for more information.
3. Preliminary Structure Plans – This design step involves preparation of a general plan, elevation, span arrangement, typical section and cost estimate for the new bridge structure. The Site Investigation Report is used to identify possible poor foundation conditions and may require modification of the structure geometry and span arrangement. This step may require additional geotechnical input, especially if substructure locations must be changed.
4. Final Contract Plans for Structures – This design step culminates in final plans, details, special provisions and cost estimates for construction. The Subsurface Exploration sheets are part of the Final Contract Plans. Unless design changes are required at this step, additional geotechnical input is not typically required to prepare foundation details for the Final Contract Plans.

11.1.2 Foundation Type Selection

The following items need to be assessed to select site-specific foundation types:

- Magnitude and direction of loading.
- Depth to suitable bearing material.
- Potential for liquefaction, undermining or scour.
- Frost potential.



Steel pile can be used in friction, point-bearing, a combination of both or rock-socketed piles. One advantage of steel pile is the ease of splicing or cutting to accommodate differing final constructed lengths.

Steel pile should not be used for exposed pile bents in corrosive environments as show in the *Facilities Development Manual, Procedure 13.1.15*.

The nominal (ultimate) structural compressive resistance of steel piles is designed in accordance with **LRFD [10.7.3.13.1]** as either noncomposite or composite sections. Composite sections include concrete-filled pipe pile and steel pile that is encased in concrete. The nominal structural compressive resistance for noncomposite and composite steel pile is further specified in **LRFD [6.9.4 and 6.9.5]**, respectively. The effective length of horizontally unsupported steel pile is determined in accordance with **LRFD [10.7.3.13.4]**. Resistance factors for the structural compression limit state are specified in **LRFD [6.5.4.2]**.

WisDOT policy item:

It is WisDOT policy to specify a yield strength of 50 ksi for steel H-piles. Although 50 ksi is specified, the structural pile design shall use a yield strength of 36 ksi. The specified yield strength of 50 ksi may be used when performing drivability analyses. For steel pipe piles, 36 ksi shall be used for pile design and drivability analyses.

11.3.1.12.3.1 H-Piles

Steel piles are generally used for point-bearing piles and typically employ what is known as the HP-section (often called H-piles for brevity). Steel H-piles are rolled sections with wide flanges such that the depth of the section and the width of the flanges are approximately equal. The cross-sectional area and volume displacement are relatively small and as a result, H-piles can be driven through compact granular materials and slightly into soft rock. Also, steel piles have little or no effect in causing ground swelling or raising of adjacent piles. Because of the small volume of H-piles, they are considered “non-displacement” piling.

H-piles are available in many sizes and lengths. Unspliced pile lengths up to 140 feet and spliced pile lengths up to 230 feet have been driven. Typical pile lengths range from 40 to 120 feet. Common H-pile sizes vary between 10 and 14 inches.

The current WisDOT practice is to design driven H-piles for a factored (ultimate structural) axial compression resistance as shown in [Table 11.3-5](#). These values are based on $\phi_c = 0.5$ for severe driving conditions **LRFD [6.5.4.2]**. See 6.3.2.1 for the typical style of plan notes showing axial resistance as well as required driving resistance on plans. **If less than the maximum axial resistance is required by design, state only the required corresponding driving resistance on the plans.**

Since granular soil is largely incompressible, the principal action at the tip of the pile is lateral displacement of soil particles. Although it is an accepted fact that steel piles develop extremely high loads per pile when driven to point-bearing on rock, some misconceptions still remain that H-piles cannot function as friction piles. Load tests indicate that steel H-piles can function quite satisfactorily as friction piles in sand, sand-clay, silt-and-sand or hard clay. However, they will typically drive to greater depths than displacement piles. The surface area



for pile frictional computations is considered to be the projected “box area” of the H-pile and not the actual steel surface area.

In compact sand, there is not significant reduction in intergranular space and no increase in free water; thus, shaft resistance is not decreased by water lubrication during driving. The pressure of the sand grains against the pile is approximately the same during driving as it is after driving is stopped. The resulting shaft resistance may be an important source of load-carrying capacity.

Clay is compressible to a far greater degree than sand or gravel. As the solid particles are pressed into closer contact with each other and water is squeezed out of the voids, only small frictional resistance to driving is generated because of the lubricating action of the free water. However, after driving is completed, the lateral pressure against the pile increases due to dissipation of the pore water pressures. This causes the fine clay particles to increase adherence to the comparatively rough surface of the pile. Load is transferred from the pile to the soil by the resulting strong adhesive bond. In many types of clay, this bond is stronger than the shearing resistance of the soil.

In hard, stiff clays containing a low percentage of voids and pore water, the compressibility is small. As a result, the amount of displacement and compression required to develop the pile’s full capacity are correspondingly small. As an H-pile is driven into stiff clay, the soil trapped between the flanges and web usually becomes very hard due to the compression and is carried down with it. This trapped soil acts as a plug and the pile also acts as a displacement pile.

In cases where loose soil is encountered, considerably longer point-bearing steel piles are required to carry the same load as relatively short displacement-type piles. This is because a displacement-type pile, with its larger cross section, produces more compaction as it is driven through materials such as soft clays or loose organic silt.

11.3.1.12.3.2 Pipe Piles

Pipe piles consist of seamless, welded or spiral welded steel pipes in diameters ranging from 7-3/4 to 24 inches. Other sizes are available, but they are not commonly used. Typical wall thicknesses range from 0.375-inch to 0.75-inch, with wall thicknesses of up to 1.5 inches possible. Pipe piles should be specified by grade with reference to ASTM A 252.

Pipe piles may be driven either open or closed end. If the end bearing capacity from the full pile toe area is required, the pile toe should be closed with a flat plate or a conical tip.

11.3.1.12.3.3 Oil Field Piles

The oil industry uses a very high quality pipe in their drilling operations. Every piece is tested for conformance to their standards. Oil field pipe is accepted as a point-bearing alternative to HP piling, provided the material in the pipe meets the requirements of ASTM A 252, Grade 3, with a minimum tensile strength of 120 ksi or a Brinell Hardness Number (BHN) of 240, a minimum outside diameter of 7-3/4 inches and a minimum wall thickness of 0.375-inch. The weight and area of the pipe shall be approximately the same as the HP piling it replaces. Sufficient bending strength shall be provided if the oil field pipe is replacing HP piling in a pile



bent. Oil field pipe is driven open-ended and not filled with concrete. The availability of this pile type varies and is subject to changes in the oil industry.

11.3.1.12.4 Pile Bents

See 13.1 for criteria to use pile bents at stream crossings. When pile bents fail to meet these criteria, pile-encased pier bents should be considered. To improve debris flow, round piles are generally selected for exposed bents. Round or H-piles can be used for encased bents.

11.3.1.13 Tolerable Movement of Substructures Founded on Driven Piles

WisDOT policy item:

For design of new bridge structures founded on driven piles at the LRFD Service Limit State, it is WisDOT's policy to limit the horizontal movement at top of the foundation unit to 0.5 inch or less at the service limit state.

11.3.1.14 Resistance Factors

The nominal (ultimate) geotechnical resistance capacity of the pile should be based on the type, depth and condition of subsurface material and ground water conditions, reported in the Geotechnical Site Investigation Report, as well as the method of analysis used to determine pile resistance capacity. Resistance factors to compute the factored geotechnical resistance are presented in **LRFD [Table 10.5.5.2.3-1]** and are selected based on the method used to determine the nominal (ultimate) axial pile capacity. The design intent is to adjust the resistance factor based on the reliability of the method used to determine the nominal pile resistance. When construction controls, such as pile driving analyzers or load tests, are used to improve the reliability of the capacity prediction, the resistance factors used during final design should be increased in accordance with **LRFD [Table 10.5.5.2.3-1]** to reflect planned construction monitoring.

WisDOT exception to AASHTO:

WisDOT requires at least four (4) piles per group to support each substructure unit, including each column for multi-column bents. WisDOT does not reduce geotechnical resistance factors to satisfy redundancy requirements to determine axial pile resistance. Hence, redundancy resistance factors in **LRFD [10.5.5.2.3]** are not applicable to WisDOT structures. This exception applies to typical CIP and H-pile foundations. Non-typical foundations (such as drilled shafts) shall be investigated individually.

No guidance regarding the structural design of non-redundant driven pile groups is currently included in *AASHTO LRFD*. Since WisDOT requires a minimum of 4 piles per substructure unit, structural design should be based on a load modifier, η , of 1.0. Further description of load modifiers is presented in **LRFD [1.3.4]**.

The following geotechnical resistance factors apply to the majority of the bridges in Wisconsin that are founded on driven pile. On the majority of WisDOT projects, wave equation analysis and dynamic monitoring are not used to set driving criteria. This equates to



typical resistance factors of 0.35 to 0.45 for pile design. A summary of resistance factors is presented in [Table 11.3-1](#), which are generally used for geotechnical design on WisDOT projects.



Table of Contents

12.1 General3

12.2 Abutment Types5

 12.2.1 Full-Retaining5

 12.2.2 Semi-Retaining.....6

 12.2.3 Sill7

 12.2.4 Spill-Through or Open7

 12.2.5 Pile-Encased8

 12.2.6 Special Designs.....8

12.3 Types of Abutment Support9

 12.3.1 Piles or Drilled Shafts9

 12.3.2 Spread Footings10

12.4 Abutment Wing Walls.....11

 12.4.1 Wing Wall Length11

 12.4.1.1 Wings Parallel to Roadway.....11

 12.4.1.2 Wings Not Parallel to Roadway and Equal Slopes12

 12.4.2 Wing Wall Loads14

 12.4.3 Wing Wall Parapets.....15

12.5 Abutment Depths, Excavation and Construction16

 12.5.1 Abutment Depths16

 12.5.2 Abutment Excavation16

12.6 Abutment Drainage and Backfill.....18

 12.6.1 Abutment Drainage18

 12.6.2 Abutment Backfill Material.....18

12.7 Selection of Standard Abutment Types20

12.8 Abutment Design Loads and Other Parameters23

 12.8.1 Application of Abutment Design Loads23

 12.8.2 Load Modifiers and Load Factors.....26

 12.8.3 Live Load Surcharge27

 12.8.4 Other Abutment Design Parameters28

 12.8.5 Abutment and Wing Wall Design in Wisconsin29

 12.8.6 Horizontal Pile Resistance29

12.9 Abutment Body Details31



12.9.1 Construction Joints.....31
12.9.2 Beam Seats.....32
12.10 Timber Abutments.....34
12.11 Bridge Approach Design and Construction Practices35

12.2.3 Sill

The sill abutment (Type A1) is constructed at the top of the slope after the roadway embankment is close to final grade, as shown in [Figure 12.2-3](#). The sill abutment helps avoid many of the problems that cause rough approach pavements. It eliminates the difficulties of obtaining adequate compaction adjacent to the relatively high walls of closed abutments. Since the approach embankment may settle by forcing up or bulging up the slope in front of the abutment body, a berm is often constructed at the front of the body. The weight of the berm helps prevent such bulging.

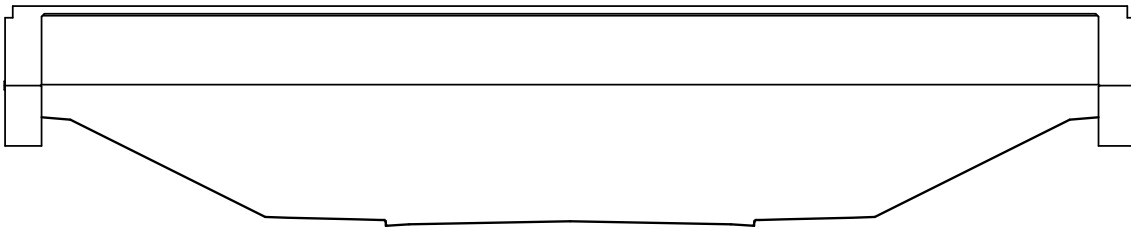

Figure 12.2-3
Sill Abutment

Sill abutments are the least expensive abutment type and are usually the easiest to construct. However, this abutment type results in a higher superstructure cost, so the overall cost of the structure should be evaluated with other alternatives.

For shallow superstructures where wing piles are not required, the Type A1 abutment is used with a fixed seat. This minimizes cracking between the body wall and wings. However, for shallow superstructures where wing piles are required, the Type A1 abutment is used with a semi-expansion seat. This allows superstructure movement, and it reduces potential cracking between the wings and body.

The parallel-to-abutment-centerline wings or elephant-ear wings, as shown on the Standard Details for Wings Parallel to A1 Abutment Centerline, should be used for grade separations when possible. This wing type is preferred because it increases flexibility in the abutment, it simplifies compaction of fill, and it improves stability. Wings parallel to the roadway are still required at stream crossings where high water may be a problem.

12.2.4 Spill-Through or Open

A spill-through or open abutment is mostly used where an additional span may be added to the bridge in the future. It may also be used to satisfy unique construction problems. This abutment type is situated on columns or stems that extend upward from the natural ground. It is essentially a pier being used as an abutment.

It is very difficult to properly compact the embankment materials that must be placed around the columns and under the abutment cap. Early settlement and erosion are problems frequently encountered with spill-through or open abutments.



If the abutment is to be used as a future pier, it is important that the wings and backwall be designed and detailed for easy removal. Construction joints should be separated by felt or other acceptable material. Reinforcing steel should not extend through the joints. Bolts with threaded inserts should be used to carry tension stresses across joints.

12.2.5 Pile-Encased

Pile-encased abutments (Type A5) should only be used where documented cost data shows them to be more economical than sill abutments due to site conditions. For local roads right-of-way acquisition can be difficult, making the A5 a good option. Requiring crane access from only one side of a stream may be another reason to use a single span bridge with A5 abutments, as would savings in railing costs. Steeper topography may make A5 abutments a more reasonable choice than sill abutments. In general, however, using sill abutments with longer bridges under most conditions has cost advantages over using the Type A5 abutments. Type A5 abutments may require additional erosion control measures that increase construction cost.

The wall height of pile-encased abutments is limited to a maximum of 10 feet since increased wall height will increase soil pressure, resulting in uneconomical pile design due to size or spacing requirements. Reinforcement in the abutment body is designed based on live load surcharge and soil pressure on the back wall.

Pile-encased abutments are limited to a maximum skew of 15 and 30 degrees with girder structures and slab structures, respectively, in order to limit damage due to thermal expansion and contraction of the superstructure. Wing skew angles are at 45 degrees relative to the body to prevent cracking between the abutment body and wings.

12.2.6 Special Designs

In addition to the standard abutment types described in the previous sections, many different styles and variations of those abutment types can also be designed. Such special abutment designs may be required due to special aesthetic requirements, unique soil conditions or unique structural reasons. Special designs of abutments require prior approval by the Bureau of Structures Development Chief.

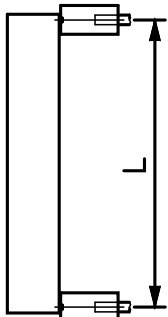
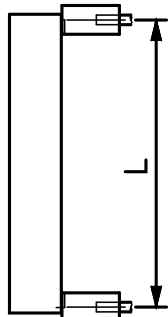
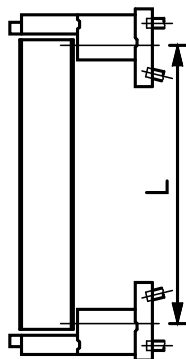
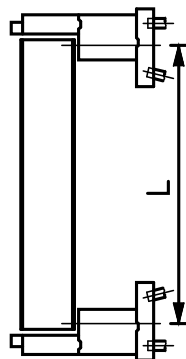
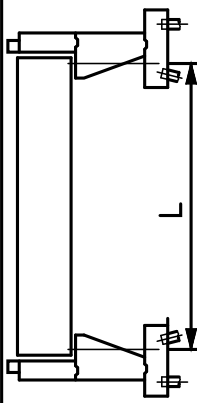
Abutment Arrangements	Superstructures		
	S=Skew, AL=Abutment Length		
	Concrete Slab Spans	Prestressed Girders	Steel Girders
<p>L=Length of continuous superstructure between abutments</p> <p>(1) Type A1 with fixed seat</p>  <p>(2) Type A1 with semi-exp. seat</p>  <p>(3) Type A3 with fixed bearing</p>  <p>(4) Type A3 with exp. bearing</p>  <p>(5) Type A4 with exp. bearing</p> 	<p>a.</p> <p>$L \leq 150'$ $S \leq 30^\circ$ $AL \leq 50'$</p>	<p>a.</p> <p>$L \leq 150'$ $S \leq 15^\circ$ $AL \leq 50'$</p>	<p>a.</p> <p>$L \leq 150'$ $S \leq 15^\circ$ $AL \leq 50'$</p>
	<p>a.</p> <p>$L < 300'$ $S \leq 30^\circ$ $AL > 50'$</p>	<p>a.</p> <p>$L < 300'$ $S \leq 40^\circ$</p>	<p>a.</p> <p>$L < 150'$ $S \leq 40^\circ$</p>
	Not used	Single span and ($S > 40^\circ$)	Single span and ($L > 150'$ or $S > 40^\circ$)
	<p>b.</p> <p>$L > 300'$ and $S \leq 30^\circ$ with rigid piers</p>	<p>L > 300' or ($S > 40^\circ$ and multi-span)</p>	<p>Multi-span and ($L > 150'$ or $S > 40^\circ$) with rigid piers</p>
	Not used	<p>c.</p> <p>Based on geometry and economics Girder D < 60"</p>	<p>d.</p> <p>Based on geometry and economics and economics Girder D < 60"</p>

ABUTMENT TYPES

Figure 12.7-1
 Recommended Guide for Abutment Type Selection



Footnotes to [Figure 12.7-1](#):

- a. Type A1 fixed abutments are not used when wing piles are required. The semi-expansion seat is used to accommodate superstructure movements and to minimize cracking between the wings and body wall. See Standards for Abutment Type A1 (Integral Abutment) and Abutment Type A1 for additional guidance.
- b. Consider the flexibility of the piers when choosing this abutment type. Only one expansion bearing is needed if the structure is capable of expanding easily in one direction. With rigid piers, symmetry is important in order to experience equal expansion movements and to minimize the forces on the substructure units.
- c. For two-span prestressed girder bridges, the sill abutment is more economical than a semi-retaining abutment if the maximum girder length is not exceeded. It also is usually more economical if the next girder size is required.
- d. For two-span steel structures with long spans, the semi-retaining abutments may be more economical than sill abutments due to the shorter bridge lengths if a deeper girder is required.



Table of Contents

13.1 General 3

 13.1.1 Pier Type and Configuration..... 3

 13.1.2 Bottom of Footing Elevation 3

 13.1.3 Pier Construction..... 4

13.2 Pier Types..... 5

 13.2.1 Multi-Column Piers 5

 13.2.2 Pile Bents 6

 13.2.3 Pile Encased Piers 7

 13.2.4 Solid Single Shaft / Hammerheads 7

 13.2.5 Aesthetics..... 8

13.3 Location 9

13.4 Loads on Piers 10

 13.4.1 Dead Loads..... 10

 13.4.2 Live Loads..... 10

 13.4.3 Vehicular Braking Force 11

 13.4.4 Wind Loads 11

 13.4.4.1 Wind Load on Superstructure..... 12

 13.4.4.2 Wind Load Applied Directly to Substructure 12

 13.4.4.3 Wind Load on Vehicles 13

 13.4.4.4 Vertical Wind Load 13

 13.4.5 Uniform Temperature Forces 13

 13.4.6 Force of Stream Current..... 16

 13.4.6.1 Longitudinal Force 16

 13.4.6.2 Lateral Force 16

 13.4.7 Buoyancy..... 17

 13.4.8 Ice 17

 13.4.8.1 Force of Floating Ice and Drift 18

 13.4.8.2 Force Exerted by Expanding Ice Sheet 19

 13.4.9 Centrifugal Force..... 19

 13.4.10 Extreme Event Collision Loads 20

13.5 Load Application 22



13.5.1 Loading Combinations.....22

13.5.2 Expansion Piers22

13.5.3 Fixed Piers23

13.6 Multi-Column Pier and Cap Design.....24

13.7 Hammerhead Pier Cap Design25

 13.7.1 Draw the Idealized Truss Model.....26

 13.7.2 Solve for the Member Forces27

 13.7.3 Check the Size of the Bearings28

 13.7.4 Design Tension Tie Reinforcement29

 13.7.5 Check the Compression Strut Capacity30

 13.7.6 Check the Tension Tie Anchorage33

 13.7.7 Provide Crack Control Reinforcement.....33

13.8 General Pier Cap Information34

13.9 Column / Shaft Design35

 13.9.1 Tapered Columns of Concrete and Timber36

13.10 Pile Bent and Pile Encased Pier Analysis.....37

13.11 Footing Design.....38

 13.11.1 General Footing Considerations.....38

 13.11.2 Isolated Spread Footings39

 13.11.3 Isolated Pile Footings41

 13.11.4 Continuous Footings43

 13.11.5 Seals and Cofferdams.....44

13.12 Quantities.....46

13.13 Appendix A – Pier Details47

13.14 Appendix B – Pile Encased Pier Construction49

13.15 Design Examples50



13.2 Pier Types

The pier types most frequently used in Wisconsin are:

- Multi-column piers (Standards for Multi-Columned Pier and for Multi-Columned Pier – Type 2)
- Pile bents (Standard for Pile Bent)
- Pile encased piers (Standard for Pile Encased Pier)
- Solid single shaft / hammerheads (Standards for Hammerhead Pier and for Hammerhead Pier – Type 2)

Design loads shall be calculated and applied to the pier in accordance with [13.4](#) and [13.5](#). The following sections discuss requirements specific to each of the four common pier types.

13.2.1 Multi-Column Piers

Multi-column piers, as shown in Standard for Multi-Columned Pier, are the most commonly used pier type for grade separation structures. Refer to [13.6](#) for analysis guidelines.

A minimum of three columns shall be provided to ensure redundancy should a vehicular collision occur. If the pier cap cantilevers over the outside columns, a square end treatment is preferred over a rounded end treatment for constructability. WisDOT has traditionally used round columns. Column spacing for this pier type is limited to a maximum of 25'.

Multi-column piers are also used for stream crossings. They are especially suitable where a long pier is required to provide support for a wide bridge or for a bridge with a severe skew angle.

Continuous or isolated footings may be specified for multi-column piers. The engineer should determine estimated costs for both footing configurations and choose the more economical configuration. Where the clear distance between isolated footings would be less than 4'-6", a continuous footing shall be specified.

A variation of the multi-column pier in Standard for Multi-Columned Pier is produced by omitting the cap and placing a column under each girder. This detail has been used for steel girders with girder spacing greater than 12'. This configuration is treated as a series of single column piers. The engineer shall consider any additional forces that may be induced in the superstructure cross frames at the pier if the pier cap is eliminated. The pier cap may not be eliminated for piers in the floodplain, or for continuous slab structures which need the cap to facilitate replacement of the slab during future rehabilitation.

See Standard for Highway Over Railroad Design Requirements for further details on piers supporting bridges over railways.



13.2.2 Pile Bents

Pile bents are most commonly used for small to intermediate stream crossings and are shown on the Standard for Pile Bent.

Pile bents shall not be used to support structures over roadways or railroads due to their susceptibility to severe damage should a vehicular collision occur.

For pile bents, pile sections shall be limited to 12" or 14" steel HP piles, or 12¾" or 14" diameter cast-in-place reinforced concrete piles with steel shells spaced at a minimum center-to-center spacing of 3'. A minimum of five piles per pier shall be used on pile bents. When a satisfactory design cannot be developed with one of these pile sections at the minimum spacing, another pier type should be selected. The outside piles shall be battered 2" per foot, and the inside piles shall be driven vertically.

Because of the minimum pile spacing, the superstructure type used with pile bents is generally limited to cast-in-place concrete slabs, prestressed girders and steel girders with spans under 70' and precast, prestressed box girders less than 21" in height.

To ensure that pile bents are capable of resisting the lateral forces resulting from floating ice and debris or expanding ice, the maximum distance from the top of the pier cap to the stable streambed elevation, including scour, is limited to:

- 15' for 12" piles or 12¾" diameter piles
- 20' for 14" piles or 14" diameter piles

Use of the pile values in Table 11.3-5 or Standard for Pile Details is valid for open pile bents due to the exposed portion of the pile being inspectable.

The minimum longitudinal reinforcing steel in cast-in-place piles with steel shells is 6-#7 bars in 12" piles and 8-#7 bars in 14" piles. The piles are designed as columns fixed from rotation in the plane of the pier at the top and at some point below streambed.

All bearings supporting a superstructure utilizing pile bents shall be fixed bearings or semi-expansion.

Pile bents shall meet the following criteria:

- If the water velocity, Q_{100} , is greater than 7 ft/sec, the quantity of the 100-year flood shall be less than 12,000 ft³/sec.
- If the streambed consists of unstable material, the velocity of the 100-year flood shall not exceed 9 ft/sec.

Pile bents may only be specified where the structure is located within Area 3, as shown in the *Facilities Development Manual, Procedure 13-1-15*, Figure 1 and where the piles are not exposed to water with characteristics that are likely to cause accelerated corrosion.



The minimum cap size shall be 3' wide by 3'-6" deep and the piles shall be embedded into the cap a minimum of 2'-0.

13.2.3 Pile Encased Piers

Pile encased piers are similar to pile bents except that a concrete encasement wall surrounds the piles. They are most commonly used for small to intermediate stream crossings where a pile bent pier is not feasible. Pile encased piers are detailed on Standard for Pile Encased Pier.

An advantage of this pier type is that the concrete encasement wall provides greater resistance to lateral forces than a pile bent. Also the hydraulic characteristics of this pier type are superior to pile bents, resulting in a smoother flow and reducing the susceptibility of the pier to scour at high water velocities. Another advantage is that floating debris and ice are less likely to accumulate against a pile encased pier than between the piles of a pile bent. Debris and ice accumulation are detrimental because of the increased stream force they induce. In addition, debris and ice accumulation cause turbulence at the pile, which can have the effect of increasing the local scour potential.

Pile sections shall be limited to 10", 12" or 14" steel HP piles, or 10³/₄", 12³/₄" or 14" diameter cast-in-place concrete piles with steel shells. Minimum center-to-center spacing is 3'. Where difficult driving conditions are expected, oil field pipe may be specified in the design. A minimum of five piles per pier shall be used. When a satisfactory design cannot be developed with one of these pile sections at the minimum spacing, another pier type should be selected. The inside and outside piles shall be driven vertically.

Pile encased piers should not be used for normal water depths greater than 10', since this is the maximum practical depth for setting formwork and placing the reinforcing steel. Total pier height shall be less than 25 feet.

All bearings supporting a superstructure utilizing pile encased piers shall be fixed bearings or semi-expansion.

The connection between the superstructure and the pier shall be designed to transmit the portion of the superstructure design loads assumed to be taken by the pier.

The concrete wall shall be a minimum of 2'-6" thick. The top 3' of the wall is made wider if a larger bearing area is required. See Standard for Pile Encased Pier for details. The bottom of the wall shall be placed 2' to 4' below stable streambed elevation, depending upon stream velocities and frost depth.

The concrete in the encasement wall may be placed under water if the procedure detailed in [13.14](#) is followed.

13.2.4 Solid Single Shaft / Hammerheads

Solid single shaft piers are used for all types of crossings and are detailed on Standards for Hammerhead Pier and for Hammerhead Pier – Type 2. The choice between using a multi-



column pier and a solid single shaft pier is based on economics and aesthetics. For high level bridges, a solid single shaft pier is generally the most economical and attractive pier type available.

The massiveness of this pier type provides a large lateral load capacity to resist the somewhat unpredictable forces from floating ice, debris and expanding ice. They are suitable for use on major rivers adjacent to shipping channels without additional pier protection. When used adjacent to railroad tracks, crash walls are not required.

If a cofferdam is required and the upper portion of a single shaft pier extends over the cofferdam, an optional construction joint is provided 2' above the normal water elevation. Since the cofferdam sheet piling is removed by extracting vertically, any overhead obstruction prevents removal and this optional construction joint allows the contractor to remove sheet piling before proceeding with construction of the overhanging portions of the pier.

A hammerhead pier shall not be used when the junction between the cap and the shaft would be less than the cap depth above normal water. Hammerhead piers are not considered aesthetically pleasing when the shaft exposure above water is not significant. A feasible alternative in this situation would be a wall type solid single shaft pier or a multi-column pier. On a wall type pier, both the sides and ends may be sloped if desired, and either a round, square or angled end treatment is acceptable. If placed in a waterway, a square end type is less desirable than a round or angled end.

13.2.5 Aesthetics

Refer to [13.13](#) for suggested alternative pier shapes. These shapes are currently being studied so no standard details are shown. It is desirable to standardize alternate shapes for efficiency and economy of construction. Use of these alternate pier shapes for aesthetics should be approved by the Chief Structures Development Engineer so that standard details can be developed.

Refer to Chapter 4 for additional information about aesthetics.



Expansion piers with elastomeric bearings are designed based on the force that the bearings resist, with longitudinal force being applied at the bearing elevation. This force is applied as some combination of temperature force, braking force, and/or wind load depending on what load case generates the largest deflection at the bearing. The magnitude of the force shall be computed as follows:

$$F = \frac{GA\Delta n}{t}$$

Where:

- F = Elastomeric bearing force used for pier design (kips)
- G = Shear modulus of the elastomer (ksi)
- A = Bearing pad area (in²)
- Δ = Deflection at bearing from thermal or braking force (in)
- n = Number of bearings per girder line; typically one for continuous steel girders and two for prestressed concrete beams (dimensionless)
- t = Total elastomer thickness (without steel laminates) (in)

Example E27-1.8 illustrates the calculation of this force.

See [13.4.5](#) for a discussion and example of temperature force application for all piers.

13.5.3 Fixed Piers

Transverse forces applied to expansion piers from the superstructure include loads from one-half of the adjacent span lengths, and are applied at the location of the transverse load. For fixed bearings, longitudinal forces, other than temperature, are based on loading one-half of the adjacent span lengths. The longitudinal forces are applied at the bearing elevation.

See [13.4.5](#) for a discussion and example of temperature force application for all piers.



13.6 Multi-Column Pier and Cap Design

WisDOT policy item:

Multi-column pier caps shall be designed using conventional beam theory.

The first step in the analysis of a pier frame is to determine the trial geometry of the frame components. The individual components of the frame must meet the minimum dimensions specified in 13.2.1 and as shown on the Standards. Each of the components should be sized for function, economy and aesthetics. Once a trial configuration is determined, analyze the frame and adjust the cap, columns and footings if necessary to accommodate the design loads.

When the length between the outer columns of a pier cap exceeds 65', temperature and shrinkage should be considered in the design of the columns. These effects induce moments in the columns due to the expansion and contraction of the cap combined with the rigid connection between the cap and columns. A 0.5 factor is specified in the strength limit state for the temperature and shrinkage forces to account for the long-term column cracking that occurs. A full section modulus is then used for this multi-column pier analysis. Use an increase in temperature of +35 degrees F and a decrease of -45 degrees F. Shrinkage (0.0003 ft/ft) will offset the increased temperature force. For shrinkage, the keyed vertical construction joint as required on the Standard for Multi-Columned Pier, is to be considered effective in reducing the cap length. For all temperature forces, the entire length from exterior column to exterior column shall be used.

The maximum column spacing on pier frames is 25'. Column height is determined by the bearing elevations, the bottom of footing elevation and the required footing depth. The pier cap/column and column/footing interfaces are assumed to be rigid.

The pier is analyzed as a frame bent by any of the available analysis procedures considering sidesway of the frame due to the applied loading. The gross concrete areas of the components are used to compute their moments of inertia for analysis purposes. The effect of the reinforcing steel on the moment of inertia is neglected.

Vertical loads are applied to the pier through the superstructure. The vertical loads are varied to produce the maximum moments and shears at various positions throughout the structure in combination with the horizontal forces. The effect of length changes in the cap due to temperature is also considered in computing maximum moments and shears. All these forces produce several loading conditions on the structure which must be separated to get the maximum effect at each point in the structure. The maximum moments, shears and axial forces from the analysis routines are used to design the individual pier components. Moments at the face of column are used for pier cap design.

See 13.1 and 13.2.1 for further requirements specific to this pier type.



Table of Contents

17.1 Design Method3
 17.1.1 Design Requirements.....3
 17.1.2 Rating Requirements3
 17.1.2.1 Standard Permit Design Check3
17.2 LRFD Requirements4
 17.2.1 General4
 17.2.2 WisDOT Policy Items4
 17.2.3 Limit States4
 17.2.3.1 Strength Limit State5
 17.2.3.2 Service Limit State.....5
 17.2.3.3 Fatigue Limit State.....5
 17.2.3.4 Extreme Event Limit State6
 17.2.4 Design Loads6
 17.2.4.1 Dead Loads6
 17.2.4.2 Traffic Live Loads8
 17.2.4.2.1 Design Truck.....8
 17.2.4.2.2 Design Tandem9
 17.2.4.2.3 Design Lane.....9
 17.2.4.2.4 Double Truck9
 17.2.4.2.5 Fatigue Truck10
 17.2.4.2.6 Live Load Combinations10
 17.2.4.3 Multiple Presence Factor11
 17.2.4.4 Dynamic Load Allowance12
 17.2.4.5 Pedestrian Loads.....12
 17.2.5 Load Factors13
 17.2.6 Resistance Factors.....13
 17.2.7 Distribution of Loads for Slab Structures14
 17.2.8 Distribution of Loads for Girder Structures24
 17.2.9 Distribution of Dead Load to Substructure Units37
 17.2.10 Distribution of Live Loads to Substructure Units37
 17.2.11 Composite Section Properties.....39



17.2.12 Allowable Live Load Deflection40

17.2.13 Actual Live Load Deflection.....40

17.3 Selection of Structure Type.....42

 17.3.1 Alternate Structure Types.....42

17.4 Superstructure Types.....44

17.5 Design of Slab on Girders.....47

 17.5.1 General47

 17.5.2 Two-Course Deck Construction47

 17.5.3 Reinforcing Steel for Deck Slabs on Girders.....48

 17.5.3.1 Transverse Reinforcement48

 17.5.3.2 Longitudinal Reinforcement.....54

 17.5.3.3 Empirical Design of Slab on Girders.....58

17.6 Cantilever Slab Design60

 17.6.1 Rail Loading for Slab Structures.....67

 17.6.2 WisDOT Overhang Design Practices67

17.7 Construction Joints72

17.8 Bridge Deck Protective Systems.....73

17.9 Bridge Approaches74

17.10 Design of Precast Prestressed Concrete Deck Panels.....75

 17.10.1 General75

 17.10.2 Deck Panel Design.....75

 17.10.3 Transverse Reinforcement for Cast-in-Place Concrete on Deck Panels77

 17.10.3.1 Longitudinal Reinforcement.....78

 17.10.4 Details78



17.2.3.1 Strength Limit State

The strength limit state shall be applied to ensure that strength and stability are provided to resist the significant load combinations that a bridge is expected to experience during its design life. The total factored force effect must not exceed the factored resistance.

Strength I is used for the ultimate capacity of structural members and relates to the normal vehicular use of the bridge without wind.

Strength II is not typically used by WisDOT. However, Wisconsin Standard Permit Vehicle (Wis-SPV) must be checked in accordance with Chapter 45 – Bridge Rating.

Strength III is not typically used as a final-condition design check by WisDOT.

WisDOT policy item:

Strength III can be used as a construction check for steel girder bridges with wind load but no live load.

Strength IV is not typically used by WisDOT. Spans > 300 ft. should include this limit state.

Strength V relates to the normal vehicular use of the bridge with a wind velocity of 55 mph. This limit state is used in the design of steel structures to check lateral bending stresses in the flanges.

17.2.3.2 Service Limit State

The service limit state shall be applied to restrict stress, deformation and crack width under regular service conditions. The total factored force effect must not exceed the factored resistance.

Service I relates to the normal vehicular use of the bridge. This limit state is used to check general serviceability requirements such as deflections and crack control. This load combination is also used to check compressive stresses in prestressed concrete components.

Service II is intended to control yielding of steel structures and slip of slip-critical connections due to vehicular live loads.

Service III is used to check the tensile stresses in prestressed concrete superstructures with the objective of crack control.

17.2.3.3 Fatigue Limit State

The fatigue limit state shall be applied as a restriction on stress range as a result of a single design truck occurring at the number of expected stress range cycles. The fatigue limit state is intended to limit crack growth under repetitive loads to prevent fracture during the design life of the bridge. The total factored force effect must not exceed the factored resistance.



Fatigue I is related to infinite load-induced fatigue life. This load combination should be checked for longitudinal slab bridge reinforcement and longitudinal continuity reinforcement on prestressed concrete girder and steel girder bridges. Fatigue I is used for steel girder structures to determine whether or not a tensile stress could exist at a particular location. This load combination is also used for any fracture-critical members as well as components and details not meeting the requirements for Fatigue II.

Fatigue II is related to finite load-induced fatigue life. If the projected 75-year single lane Average Daily Truck Traffic is less than or equal to a prescribed value for a given component or detail, that component or detail should be designed for finite life using the Fatigue II load combination.

17.2.3.4 Extreme Event Limit State

The extreme event limit state shall be applied for deck overhang design as specified in [Table 17.6-1](#). For the extreme limit state, the applied loads for deck overhang design are horizontal and vertical vehicular collision forces. These forces are checked at the inside face of the barrier, the design section for the overhang and the design section for the first bay, as described in [17.6](#).

Extreme Event II is used to design deck reinforcement due to vehicular collision forces.

17.2.4 Design Loads

In LRFD design, structural materials must be able to resist their applied design loads. Two general types of design loads are permanent and transient. Permanent loads include dead load and earth load. Transient loads include live loads, wind, temperature, braking force and centrifugal force.

17.2.4.1 Dead Loads

Superstructures must be designed to resist dead load effects. In LRFD, dead load components consist of DC and DW dead loads. DC dead loads include structural components and nonstructural attachments, and DW dead loads include wearing surfaces and utilities. Different load factors are used for DC and DW dead loads, as described in [17.2.5](#), to account for the differences in the predictability of the loading. In addition, some dead loads are resisted by the non-composite section and other dead loads are resisted by the composite section.

[Table 17.2-1](#) summarizes the various dead load components that are commonly included in beam-on-slab superstructure design. For slab structures, all loads presented in this table are resisted by the slab.

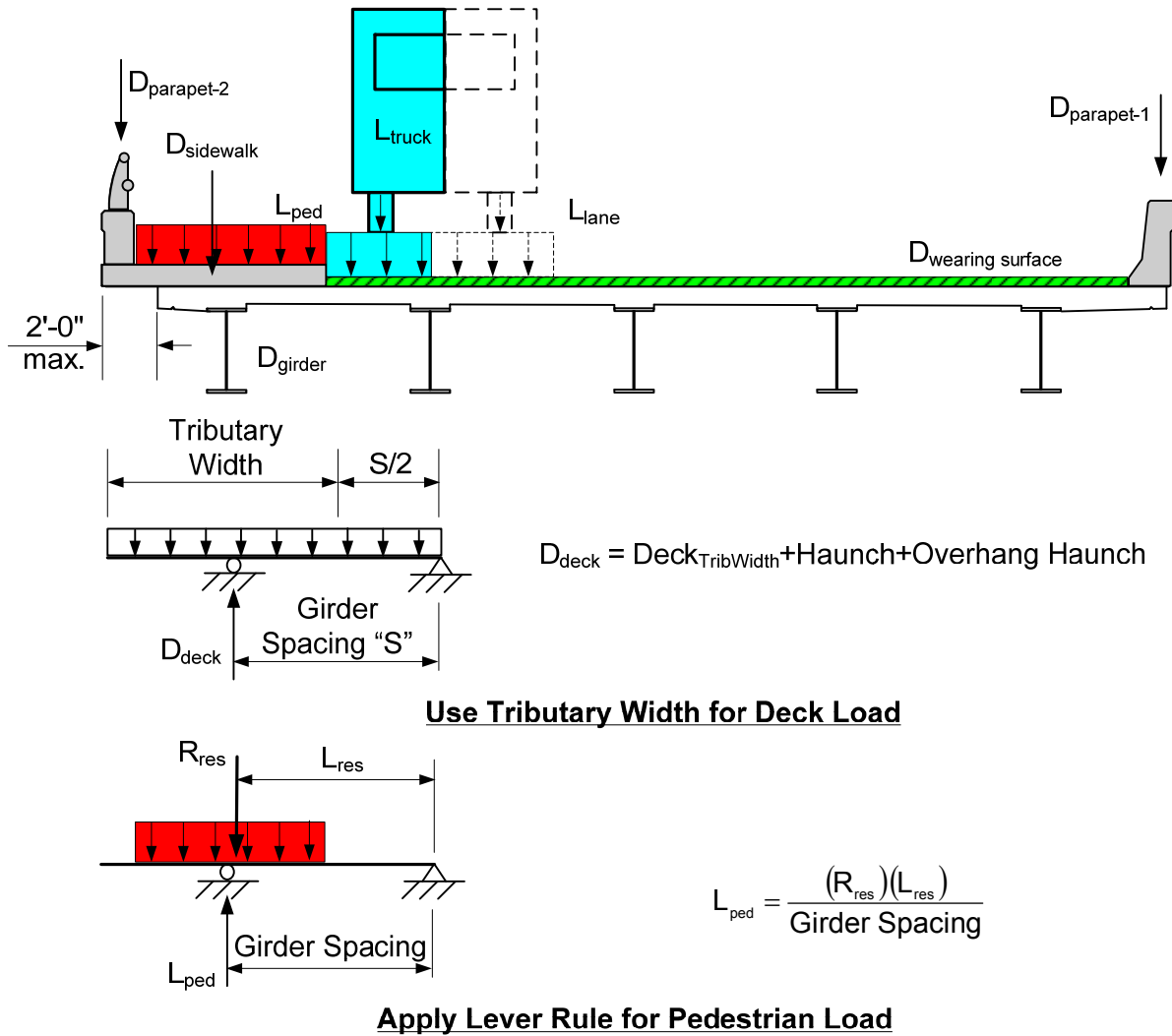

Figure 17.2-19

Distribution of Loads to Exterior Girder for Girder Structure with Raised Sidewalk Design Case 3

The distribution of loads to the exterior girder for Design Case 3 is calculated as follows:

For dead loads, the exterior girder must resist the girder weight (girder self-weight and any other miscellaneous weight applied to the girder), deck weight (including the concrete haunch and overhang haunch) and all superimposed dead loads. The distribution of the deck weight to the exterior girder is based on the tributary width, as shown in the previous figure. The distribution of all superimposed dead loads is based on equal distribution to all girders.

For the live load, the live load distribution factor for Design Case 3 is based only on the application of the lever rule. The appropriate multiple presence factor of 1.0 must be applied.



For pedestrian loads, the distribution to the exterior girder is based on the lever rule, as shown in the previous figure.

The general equation for loads applied to the exterior girder is as follows:

$$\text{Total Load} = D_{\text{girder}} + D_{\text{deck}} + \left(\frac{D_{\text{wearing surface}} + D_{\text{sidewalk}} + D_{\text{parapet-1}} + D_{\text{parapet-2}}}{\text{No. of Girders}} \right) + L_{\text{ped}} + [(DF_{\text{ext}})(L_{\text{truck}} + L_{\text{lane}})]$$



17.2.9 Distribution of Dead Load to Substructure Units

For abutment design, the composite dead loads may be distributed equally between all of the girders, or uniformly across the slab.

For pier design, the composite dead loads should be distributed equally between all of the girders, or uniformly across the slab, except for bridges with raised sidewalks. For girder bridges with raised sidewalks, follow the aforementioned Design Case 1 & 3 used for exterior girder design. For slab bridges with raised sidewalks, use the loading specified in Live Load Case 1 for exterior strips.

It is acceptable to consider the concrete diaphragm loads to be divided equally between all of the girders and added as point loads to the girder reactions.

17.2.10 Distribution of Live Loads to Substructure Units

See [17.2.9](#) for additional live load guidance regarding bridges with raised sidewalks. In the transverse direction, the design truck and design tandem should be located in such a way that the effect being considered is maximized. However, the center of any wheel load must not be closer than 2 feet from the edge of the design lane. The transverse live load configuration for a design truck or design tandem is illustrated in [Figure 17.2-20](#). Pedestrian live load may be omitted if trying to maximize positive moment in a multi-columned pier cap.

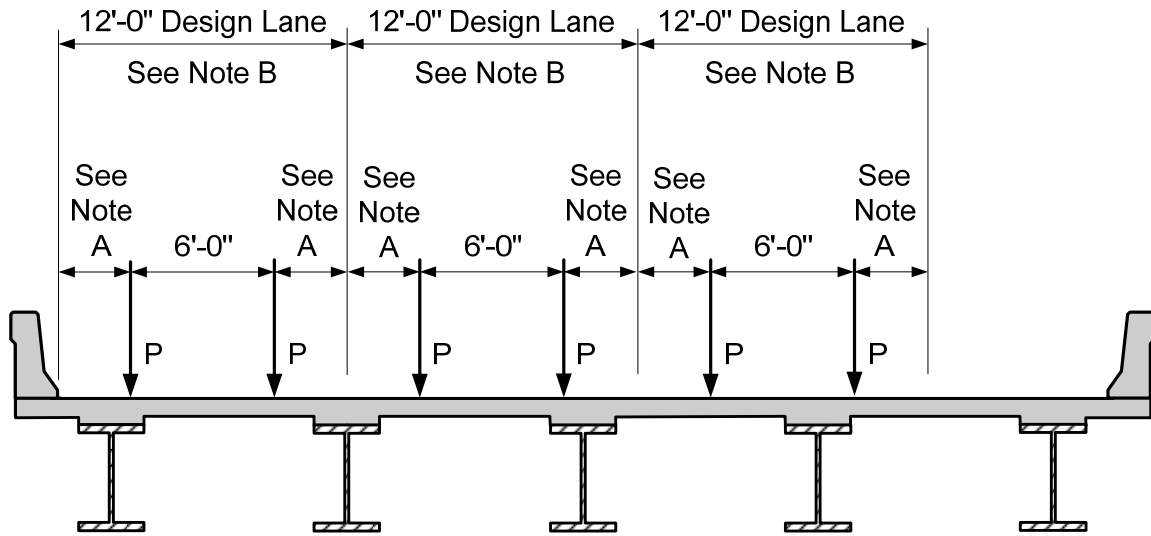

P = Wheel Load

Note A: Position wheel loads within the design lane such that the effect being considered is maximized; minimum = 2'-0".

Note B: Position design lanes across the roadway such that the effect being considered is maximized.

Figure 17.2-20

Transverse Configuration for a Design Truck or Design Tandem

Similarly, the design lane is distributed uniformly over the 10-foot loaded width. Since the design lane is 0.64 kips per linear foot in the longitudinal direction and it acts over a 10-foot width, the design lane load is equivalent to 64 psf. Similar to a design truck or design tandem, the 10-foot loaded width is positioned within the 12-foot design lane such that the effect being considered is maximized, as illustrated in [Figure 17.2-21](#). The 10-foot loaded width may be placed at the edge of the 12-foot design lane.



17.6.1 Rail Loading for Slab Structures

For concrete slab superstructures, the designer is required to consider the rail loading and provide adequate transverse reinforcing steel, accordingly. The top transverse slab reinforcement for both concrete parapet and steel railing type "M" or "W" are shown on the Standard Details.

17.6.2 WisDOT Overhang Design Practices

WisDOT policy item:

Current design practice in Wisconsin limits the standard slab overhang length to 3'-7", measured from the centerline of the exterior girder to the edge of the slab. A 4'-0" overhang is allowed for some wide flange prestressed concrete girders (54W", 72W", 82W"). A 4'-6" overhang may be used where a curved roadway is placed on straight girders at the discretion of the designer. The total overhang when a cantilevered sidewalk is used is limited to 5'-0", measured from the centerline of the exterior girder to the edge of the sidewalk. A minimum of 6" from the edge of the top flange to the edge of the deck should be provided, with 9" preferred.

The overhang length has been limited to prevent rotation of the girder and bending of the girder web during construction caused by the eccentric load from the cantilevered forming brackets. The upper portion of these brackets attaches to the girder top flange, and the lower portion bears against the girder web. If the girder rotates or the web bends at the bracket bearing point, the end of the bracket will move downward because of bracket rotation. If the rails supporting the paving machine are located near the end of the bracket, the paving machine will move downward more than the girder and the anticipated profile grade line will not be achieved. Factors affecting girder rotation are diaphragm spacing, stiffness, connections and girder torsional stiffness. Factors affecting web bending are stiffener spacing and web thickness. Do not place a note or detail on the plan for exterior girder bracing required by the contractor as this is covered by the specs.

In the following tables, the slab thickness, "t", is the slab thickness between interior girders. The area of steel shown in the following tables is the controlling value from Design Case 1, 2 or 3. The value shown is the larger area of steel required at the front face of the barrier or at the design section. Girder Type 1 shall include steel girders and the following prestressed girders; 28-inch, 36-inch, 36W-inch, 45W-inch. Prestressed girders used for rehabilitation projects, 45-inch, 54-inch and 70-inch, shall also be considered to be Girder Type 1. Girder Type 2 shall include the following prestressed girders; 54W-inch, 72W-inch and 82W-inch.

If the area of reinforcing steel required in the overhang is greater than the area of reinforcing steel provided by the standard transverse reinforcement over the interior girders, reinforcement must be added to satisfy the overhang design requirements. The amount of reinforcement that must be added in the overhang is the amount required to satisfy the overhang design requirement minus the amount provided by the standard transverse reinforcement over the interior girders. This additional reinforcement should be carried for the bar development length past the exterior girder centerline. The reinforcement shall be placed as detailed in [Figure 17.6-8](#). Use either a number 4 or 5 bar to satisfy this



requirement. The additional bar shall be placed at one or two times the standard transverse bar spacing as required.

Effective Overhang (Feet)	Deck Thickness Between Girders, "t" (Inches)						
	8	8.5	9	9.5	10	10.5	11
1.75	0.706	0.651	0.607	0.57	0.538	0.511	0.514
2.00	0.723	0.668	0.622	0.583	0.55	0.519	0.509
2.25	0.739	0.682	0.634	0.594	0.559	0.527	0.505
2.50	0.754	0.694	0.644	0.601	0.565	0.534	0.507
2.75	0.766	0.704	0.652	0.609	0.572	0.54	0.512
3.00	0.777	0.713	0.66	0.615	0.577	0.544	0.516
3.25	0.786	0.72	0.666	0.62	0.582	0.548	0.519
3.50	0.795	0.727	0.671	0.625	0.586	0.552	0.522
3.75	0.826	0.748	0.676	0.629	0.589	0.555	0.524
4.00	0.928	0.835	0.727	0.668	0.613	0.571	0.527

Table 17.6-2

Reinforcing Steel (in²/ft) for Cantilever Deck Slabs with Sloped Face Concrete Parapets
Girder Type 1

Effective Overhang (Feet)	Deck Thickness Between Girders, "t" (Inches)						
	8	8.5	9	9.5	10	10.5	11
1.25	0.724	0.669	0.623	0.584	0.550	0.520	0.509
1.5	0.724	0.669	0.623	0.584	0.550	0.520	0.509
1.75	0.724	0.669	0.623	0.584	0.550	0.520	0.509
2	0.724	0.669	0.623	0.584	0.550	0.520	0.509
2.25	0.699	0.644	0.599	0.561	0.553	0.531	0.510
2.5	0.695	0.642	0.597	0.559	0.545	0.546	0.525
2.75	0.692	0.639	0.594	0.556	0.535	0.549	0.540
3	0.690	0.637	0.593	0.555	0.525	0.539	0.553
3.25	0.688	0.635	0.592	0.553	0.522	0.528	0.543

Table 17.6-3

Reinforcing Steel (in²/ft) for Cantilever Deck Slabs with Sloped Face Concrete Parapets
Girder Type 2



E18-1 Continuous 3-Span Haunched Slab - LRFD

A continuous 3-span haunched slab structure is used for the design example. The same basic procedure is applicable to continuous flat slabs. The AASHTO LRFD Bridge Design Specifications are followed as stated in the text of this chapter. Design using a slab width equal to one foot. (Example is current through LRFD Fifth Edition - 2010)

E18-1.1 Structure Preliminary Data

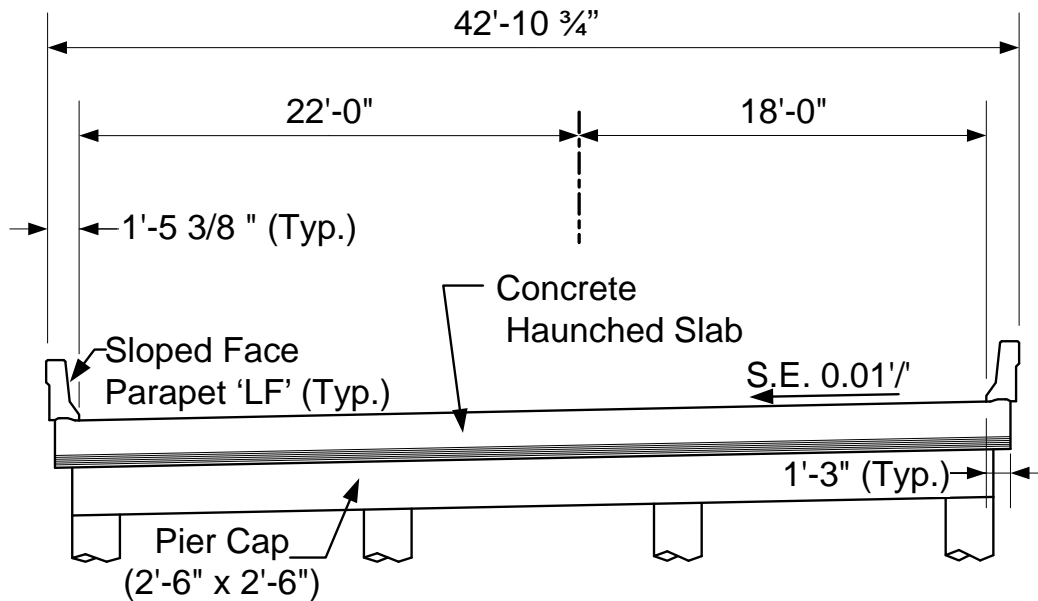

Figure E18.1

Section Perpendicular to Centerline

Live Load: HL-93
(A1) Fixed Abutments at both ends
Parapets placed after falsework is released

Geometry:

- L₁ := 38.0 ft Span 1
- L₂ := 51.0 ft Span 2
- L₃ := 38.0 ft Span 3
- slab_{width} := 42.5 ft out to out width of slab
- skew := 6 deg skew angle (RHF)
- w_{roadway} := 40.0 ft clear roadway width

Material Properties: (See 18.2.2)

- f'_c := 4 ksi concrete compressive strength



$f_y := 60$ ksi yield strength of reinforcement

$E_c := 3800$ ksi modulus of elasticity of concrete

$E_s := 29000$ ksi modulus of elasticity of reinforcement

$n := 8$ E_s / E_c (modular ratio)

Weights:

$w_c := 150$ pcf concrete unit weight

$w_{LF} := 387$ plf weight of Type LF parapet (each)

E18-1.2 LRFD Requirements

For concrete slab design, the slab dimensions and the size and spacing of reinforcement shall be selected to satisfy the equation below for all appropriate Limit States: (See 18.3.2.1)

$$Q = \sum \eta_i \cdot \gamma_i \cdot Q_i \leq \phi \cdot R_n = R_r \quad \text{(Limit States Equation)}$$

The value of the load modifier is:

$\eta_i := 1.0$ for all Limit States (See 18.3.2.2)

The force effect, Q_i , is the moment, shear, stress range or deformation caused by applied loads.

The applied loads from **LRFD [3.3.2]** are:

DC = dead load of slab (DC_{slab}), 1/2 inch wearing surface ($DC_{1/2"WS}$) and parapet dead load (DC_{para}) - (See E18-1.3)

DW = dead load of future wearing surface (DW_{FWS}) - (See E18-1.3)

LL+IM = vehicular live load (LL) with dynamic load allowance (IM) - (See E18-1.4)

The Influence of ADTT and skew on force effects, Q_i , are ignored for slab bridges (See 18.3.2.2).

The values for the load factors, γ_i , (for each applied load) and the resistance factors, ϕ , are found in Table E18.1.

The total factored force effect, Q , must not exceed the factored resistance, R_r . The nominal resistance, R_n , is the resistance of a component to the force effects.



Table of Contents

19.1 Introduction3
 19.1.1 Pretensioning3
 19.1.2 Post-Tensioning3
19.2 Basic Principles.....4
19.3 Pretensioned Member Design7
 19.3.1 Design Strengths.....7
 19.3.2 Loading Stages8
 19.3.2.1 Prestress Transfer8
 19.3.2.2 Losses8
 19.3.2.2.1 Elastic Shortening8
 19.3.2.2.2 Time-Dependent Losses9
 19.3.2.2.3 Fabrication Losses9
 19.3.2.3 Service Load.....10
 19.3.2.3.1 I-Girder.....10
 19.3.2.3.2 Box Girder.....10
 19.3.2.4 Factored Flexural Resistance11
 19.3.2.5 Fatigue Limit State.....11
 19.3.3 Design Procedure.....11
 19.3.3.1 I-Girder Member Spacing12
 19.3.3.2 Box Girder Member Spacing12
 19.3.3.3 Dead Load12
 19.3.3.4 Live Load13
 19.3.3.5 Live Load Distribution13
 19.3.3.6 Dynamic Load Allowance13
 19.3.3.7 Deck Design13
 19.3.3.8 Composite Section14
 19.3.3.9 Design Stress15
 19.3.3.10 Prestress Force15
 19.3.3.11 Service Limit State.....16
 19.3.3.12 Raised, Draped or Partially Debonded Strands.....17
 19.3.3.12.1 Raised Strand Patterns18
 19.3.3.12.2 Draped Strand Patterns18



19.3.3.12.3 Partially Debonded Strand Patterns.....20

19.3.3.13 Strength Limit State21

 19.3.3.13.1 Factored Flexural Resistance22

 19.3.3.13.2 Minimum Reinforcement24

19.3.3.14 Non-prestressed Reinforcement.....25

19.3.3.15 Horizontal Shear Reinforcement25

19.3.3.16 Web Shear Reinforcement27

19.3.3.17 Continuity Reinforcement30

19.3.3.18 Camber and Deflection.....33

 19.3.3.18.1 Prestress Camber34

 19.3.3.18.2 Dead Load Deflection37

 19.3.3.18.3 Residual Camber37

19.3.4 Deck Forming37

 19.3.4.1 Equal-Span Continuous Structures39

 19.3.4.2 Unequal Spans or Curve Combined With Tangent39

19.3.5 Construction Joints.....40

19.3.6 Strand Types.....40

19.3.7 Construction Dimensional Tolerances.....40

19.3.8 Prestressed Girder Sections40

 19.3.8.1 Pretensioned I-Girder Standard Strand Patterns.....45

19.3.9 Precast, Prestressed Slab and Box Sections Post-Tensioned Transversely45

 19.3.9.1 Available Slab and Box Sections and Maximum Span Lengths46

 19.3.9.2 Overlays47

 19.3.9.3 Mortar Between Precast, Prestressed Slab and Box Sections.....47

19.4 Field Adjustments of Pretensioning Force48

19.5 References.....50

19.6 Design Examples51



carried by the composite section. A composite floor of 3" minimum thickness is recommended.

Note that the slab and box girders are generally used for single span structures. Therefore, both dead and live loads are carried on a simple span basis.

Slab and box girders shall not be used on continuous spans. An exception may be allowed for extreme cases with prior approval from the BOS.

19.3.2.4 Factored Flexural Resistance

At the final stage, the factored flexural resistance of the composite section is considered. Since the member is designed on a service load basis, it must be checked for its factored flexural resistance at the Strength I limit state. See section 17.2.3 for a discussion on limit states.

The need for both service load and strength computations lies with the radical change in a member's behavior when cracks form. Prior to cracking, the gross area of the member is effective. As a crack develops, all the tension in the concrete is picked up by the reinforcement. If the percentage of reinforcement is small, there is very little added capacity between cracking and failure.

19.3.2.5 Fatigue Limit State

At the final stage, the member is checked for the Fatigue I limit state. See section 17.2.3 for a discussion on limit states. Allowable compressive stresses in the concrete and tensile stresses in the non-prestressed reinforcement are checked.

19.3.3 Design Procedure

The intent of this section is to provide the designer with a general outline of steps for the design of pretensioned members. Sections of interest during design include, but are not limited to, the following locations:

- 10th points
- Hold-down points
- Regions where the prestress force changes (consider the effects of transfer and development lengths, as well as the effects of debonded strands)
- Critical section(s) for shear

The designer must consider the amount of prestress force at each design section, taking into account the transfer length and development length, if appropriate.



19.3.3.1 I-Girder Member Spacing

A trial I-girder arrangement is made by using [Table 19.3-1](#) and [Table 19.3-2](#) as a guide. An ideal spacing results in equal strands for interior and exterior girders, together with an optimum slab thickness. Current practice is to use a minimum haunch of (1-1/4" plus deck cross slope times one-half top flange width) for section property calculations and then use a 3" average haunch for concrete preliminary quantity calculations. After preliminary design this value should be revised as needed as outlined in [19.3.4](#). The maximum slab overhang dimensions are detailed in [17.6.2](#).

For I-girder bridges, other than pedestrian or other unusual structures, four or more girders shall be used.

19.3.3.2 Box Girder Member Spacing

The pretensioned slab or box is used in a multi-beam system only. Precast units are placed side by side and locked (post-tensioned) together. The span length, desired roadway width and live loading control the size of the member.

When selecting a 3' wide section vs. 4' wide section, do not mix 3' wide and 4' wide sections across the width of the bridge. Examine the roadway width produced by using all 3' sections or all 4' sections and choose the system that is the closest to but greater than the required roadway width. For a given section depth and desired roadway width, a multi-beam system with 4' sections can span greater lengths than a system with 3' sections. Therefore if 3' sections are the best choice for meeting roadway width criteria, if the section depth cannot be increased and if the span length is too long for this system, then examine switching to all 4' sections to meet this required span length. [Table 19.3-3](#) states the approximate span limitations as a function of section depth and roadway width.

19.3.3.3 Dead Load

For a detailed discussion of the application of dead load, refer to [17.2.4.1](#).

The dead load moments and shears due to the girder and concrete deck are computed for simple spans. When superimposed dead loads are considered, the superimposed dead load moments are based on continuous spans.

A superimposed dead load of 20 psf is to be included in all designs which account for a possible future concrete overlay wearing surface. The future wearing surface shall be applied between the faces of curbs or parapets and shall be equally distributed among all the girders in the cross section.

For a cross section without a sidewalk, any curb or parapet dead load is distributed equally to all girders.

For a cross section with a sidewalk and barrier on the overhang, sidewalk and barrier dead loads shall be applied to the exterior girder by the lever rule. These loads shall also be applied to the interior girder by dividing the weight equally among all the girders. A more detailed discussion of dead load distribution can be found in [17.2.8](#).



19.3.3.4 Live Load

The HL-93 live load shall be used for all new bridges. Refer to section 17.2.4.2 for a detailed description of the HL-93 live load, including the design truck, design tandem, design lane, and double truck.

19.3.3.5 Live Load Distribution

The live load distribution factors shall be computed as specified in **LRFD [4.6.2.2]** and as summarized in Table 17.2-7. The moment and shear distribution factors are determined using equations that consider girder spacing, span length, deck thickness, the number of girders, skew and the longitudinal stiffness parameter. Separate shear and moment distribution factors are computed for interior and exterior girders. The applicability ranges of the distribution factors shall also be considered. If the applicability ranges are not satisfied, then conservative assumptions must be made based on sound engineering judgment.

WisDOT policy item:

The typical cross section for prestressed adjacent box girders shall be type “g” as illustrated in **LRFD [Table 4.6.2.2.1-1]**. The connection between the adjacent box girders shall be considered to be only enough to prevent relative vertical displacement at the interface.

The St. Venant torsional inertia, J , for adjacent box beams with voids may be calculated as specified for closed thin-walled sections in accordance with **LRFD [C4.6.2.2.1]**.

The value of poisson's ratio shall be taken as 0.2 in accordance with **LRFD [5.4.2.5]**.

The beam spacing, S , in **LRFD [Table 4.6.2.2b-1]** shall be equal to the beam width plus the space between adjacent box sections.

See 17.2.8 for additional information regarding live load distribution.

19.3.3.6 Dynamic Load Allowance

The dynamic load allowance, IM , is given by **LRFD [3.6.2]**. Dynamic load allowance equals 33% for all live load limit states except the fatigue limit state and is not applied to pedestrian loads or the lane load portion of the HL-93 live load. See 17.2.4.3 for further information regarding dynamic load allowance.

19.3.3.7 Deck Design

The design of concrete decks on prestressed concrete girders is based on **LRFD [4.6.2.1]**. Moments from truck wheel loads are distributed over a width of deck which spans perpendicular to the girders. This width is known as the distribution width and is given by **LRFD [Table 4.6.2.1.3-1]**. See 17.5 for further information regarding deck design.



19.3.3.8 Composite Section

The effective flange width is the width of the deck slab that is to be taken as effective in composite action for determining resistance for all limit states. The effective flange width, in accordance with LRFD [4.6.2.6], is equal to the tributary width of the girder for interior girders. For exterior girders, it is equal to one half the effective flange width of the adjacent interior girder plus the overhang width. The effective flange width shall be determined for both interior and exterior beams.

For box beams, the composite flange area for an interior multi-beam is taken as the width of the member by the effective thickness of the floor. Minimum concrete overlay thickness is 3". The composite flange for the exterior member consists of the curb and the floor over that particular edge beam. Additional information on box girders may be found in 17.4.

Since the deck concrete has a lower strength than the girder concrete, it also has a lower modulus of elasticity. Therefore, when computing composite section properties, the effective flange width (as stated above) must be reduced by the ratio of the modulus of elasticity of the deck concrete divided by the modulus of elasticity of the girder concrete.

WisDOT exception to AASHTO:
WisDOT uses the formulas shown below to determine E_c for prestressed girder design. For 6 ksi girder concrete, E_c is 5,500 ksi, and for 4 ksi deck concrete, E_c is 4,125 ksi. The E_c value of 5,500 ksi for 6 ksi girder concrete strength was determined from deflection studies. These equations are used in place of those presented in LRFD [5.4.2.4] for the following calculations: strength, section properties, and deflections due to externally applied dead and live loads.

For slab concrete strength other than 4 ksi, E_c is calculated from the following formula:

$$E_c = \frac{4,125\sqrt{f'_c}}{\sqrt{4}} \text{ (ksi)}$$

For girder concrete strengths other than 6 ksi, E_c is calculated from the following formula:

$$E_c = \frac{5,500\sqrt{f'_c}}{\sqrt{6}} \text{ (ksi)}$$

WisDOT policy item:
WisDOT uses the equation presented in LRFD [5.4.2.4] (and shown below) to calculate the modulus of elasticity at the time of release using the specified value of f'_{ci} . This value of E_i is used for loss calculations and for girder camber due to prestress forces and girder self weight.

$$E_c = 33,000 \cdot K_1 \cdot w_c^{1.5} \sqrt{f'_{ci}}$$

Where:

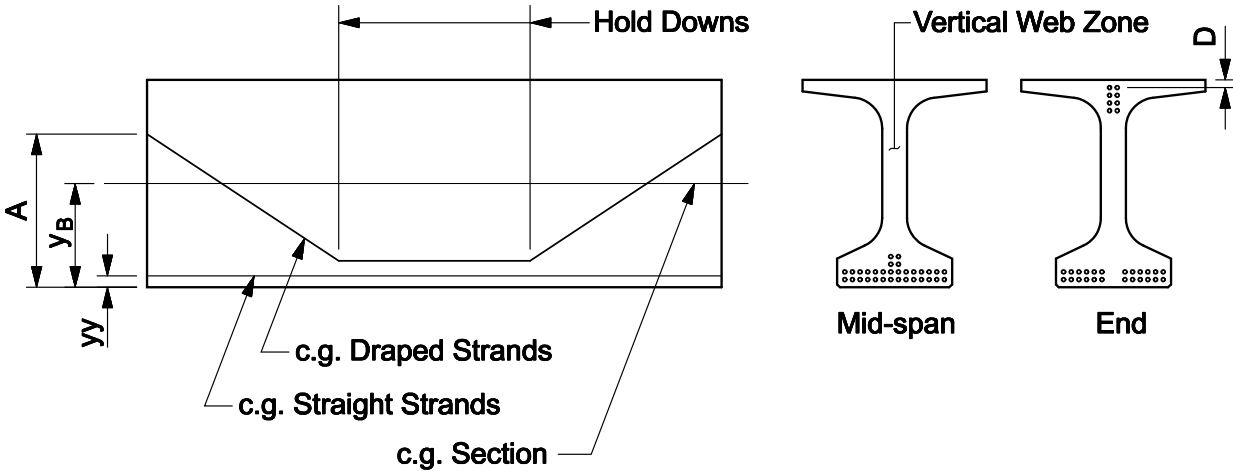

Figure 19.3-1
Typical Draped Strand Profile

Note that all the strands that lie within the “vertical web zone” of the mid-span arrangement are used in the draped group.

The engineer should show only one strand size for the draped pattern on the plans. Use only 0.5” strands for the draped pattern on 28” and 36” girders and 0.6” strands for all raised (straight) patterns for these shapes. Use 0.6” strands, only, for 36W”, 45W”, 54W”, 72W” and 82W” girders. See Chapter 40 standards for 45”, 54” and 70” girders.

The strands in slab and box girders are normally not draped but instead are arranged to satisfy the stress requirements at midspan and at the ends of the girder.

Hold-down points for draped strands are located approximately between the 1/3 point and the 4/10 point from each end of the girder. The Standard Details, Prestressed Girder Details, show B values at the 1/4 point of the girder. On the plan sheets provide values for B_{min} and B_{max} as determined by the formulas shown on the Standards.

The maximum slope specified for draped strands is 12%. This limit is determined from the safe uplift load per strand of commercially available strand restraining devices used for hold-downs. The minimum distance, D, allowed from center of strands to top of flange is 2”. For most designs, the maximum allowable slope of 12% will determine the location of the draped strands. Using a maximum slope will also have a positive effect on shear forces.

Initial girder stresses are checked at the end of the transfer length, which is located 60 strand diameters from the girder end. The transfer length is the embedment length required to develop f_{pe} , the effective prestressing steel stress (ksi) after losses. The prestressing steel stress varies linearly from 0.0 to f_{pe} along the transfer length.

The longer full development length of the strand is required to reach the larger prestressing steel stress at nominal resistance, f_{ps} (ksi). The strand stress is assumed to increase linearly from f_{pe} to f_{ps} over the distance between the transfer length and development length.

Per LRFD [5.11.4.2], the development length is:

$$l_d \geq \kappa \left(f_{ps} - \frac{2}{3} f_{pe} \right) d_b$$

Where:

- d_b = Nominal strand diameter (in)
- κ = 1.0 for members with a depth less than or equal to 24", and 1.6 for members with a depth of greater than 24"

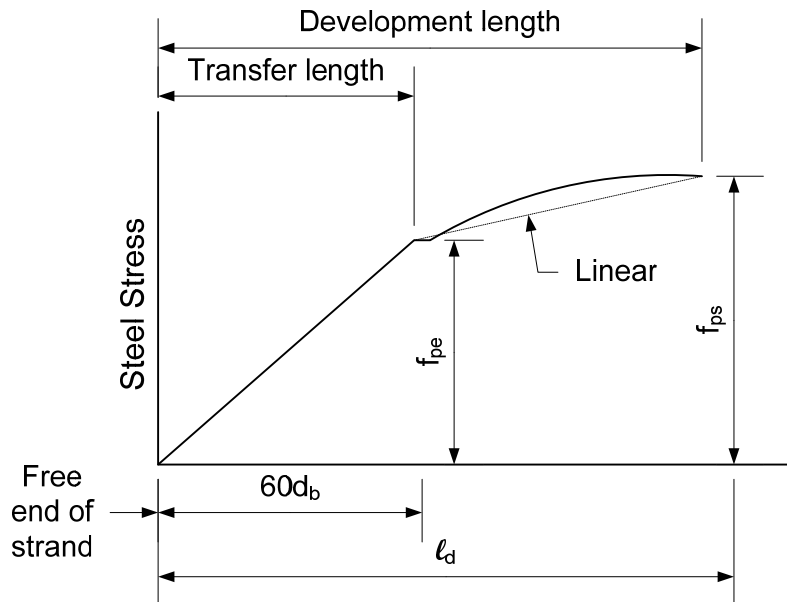

Figure 19.3-2
Transfer and Development Length

19.3.3.12.3 Partially Debonded Strand Patterns

The designer may use debonded strands if a raised or draped strand configuration fails to meet the allowable service stresses. The designer should exercise caution when using debonded strands as this may not result in the most economical design. Partially debonded strands are fabricated by wrapping sleeves around individual strands for a specified length from the ends of the girder, rendering the bond between the strand and the girder concrete ineffective for the wrapped, or shielded, length.



LRFD [5.5.4.2] allows a ϕ factor equal to 0.9 for tension-controlled reinforced concrete sections such as the bridge deck.

The continuity reinforcement consists of mild steel reinforcement in the deck in the negative moment region over the pier. Consider both the non-composite and the superimposed dead loads and live loads for the Strength I design of the continuity reinforcement in the deck.

Moment resistance is developed in the same manner as shown in [19.3.3.13.1](#) for positive moments, except that the bottom girder flange is in compression and the deck is in tension. The moment resistance is formed by the couple resulting from the compression force in the bottom flange and the tension force from the longitudinal deck steel. Consider A_s to consist of the longitudinal deck steel present in the deck slab effective flange width as determined in [19.3.3.8](#). The distance, d_p , is taken from the bottom of the girder flange to the center of the longitudinal deck steel.

WisDOT exception to AASHTO:

Composite sections formed by WisDOT standard prestressed concrete girders shall be considered to be tension-controlled for the design of the continuity reinforcement. The ϵ_t check, as specified in **LRFD [5.7.2.1]**, is not required, and $\phi = 0.9$.

WisDOT policy item:

New bridge designs shall consider only the top mat of longitudinal deck steel when computing the continuity reinforcement capacity.

WisDOT policy item:

The continuity reinforcement shall be based on the greater of either the interior girder design or exterior girder and detailed as typical reinforcement for the entire width of the bridge deck. However, do not design the continuity steel based on the exterior girder design beneath a raised sidewalk. The continuity steel beneath a raised sidewalk should not be used for rating.

Based on the location of the neutral axis, the bottom flange compressive force may behave as either a rectangle or a T-section. On WisDOT standard prestressed girders, if the depth of the compression block, a , falls within the varying width of the bottom flange, the compression block acts as an idealized T-section. In this case, the width, b , shall be taken as the bottom flange width, and the width, b_w , shall be taken as the bottom flange width at the depth “ a ”. During T-section behavior, the depth, h_f , shall be taken as the depth of the bottom flange of full width, b . See [Figure 19.3-4](#) for details. Ensure that the deck steel is adequate to satisfy $M_r \geq M_u$.

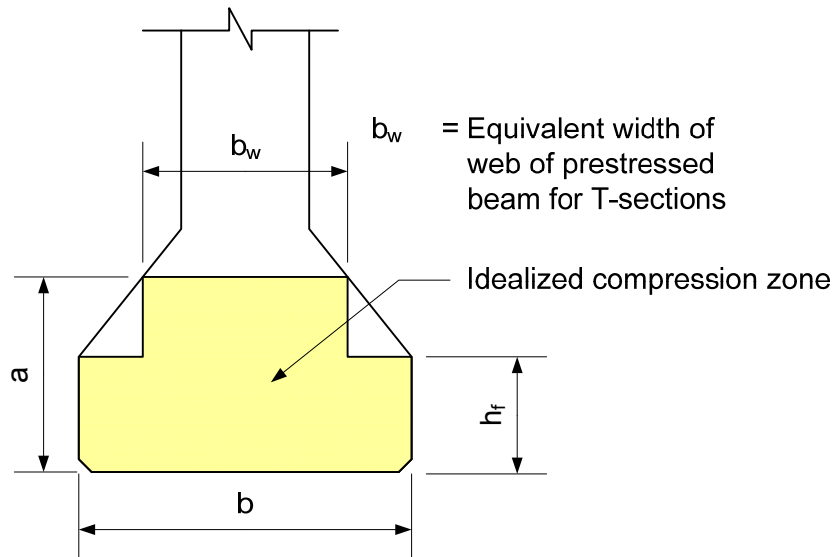

Figure 19.3-4
T-Section Compression Flange Behavior

The continuity reinforcement should also be checked to ensure that it meets the crack control provisions of **LRFD [5.7.3.4]**. This check shall be performed assuming severe exposure conditions. Only the superimposed loads shall be considered for the Service and Fatigue requirements.

The concrete between the abutting girder ends is usually of a much lesser strength than that of the girders. However, tests¹ have shown that, due to lateral confinement of the diaphragm concrete, the girder itself fails in ultimate negative compression rather than failure in the material between its ends. Therefore the ultimate compressive stress, f'_c , of the girder concrete is used in place of that of the diaphragm concrete.

This assumption has only a slight effect on the computed amount of reinforcement, but it has a significant effect on keeping the compression force within the bottom flange.

The continuity reinforcement shall conform to the Fatigue provisions of **LRFD [5.5.3]**.

The transverse spacing of the continuity reinforcement is usually taken as the whole or fractional spacing of the D bars as given in 17.5.3.2. Grade 60 bar steel is used for continuity reinforcement. Required development lengths for deformed bars are given in Chapter 9 – Materials.

WisDOT exception to AASHTO:

The continuity reinforcement is not required to be anchored in regions of the slab that are in compression at the strength limit state as stated in **LRFD [5.14.1.4.8]**. The following locations shall be used as the cut off points for the continuity reinforcement:

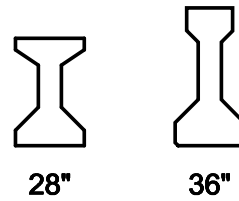

WisDOT Standard Girder Shapes

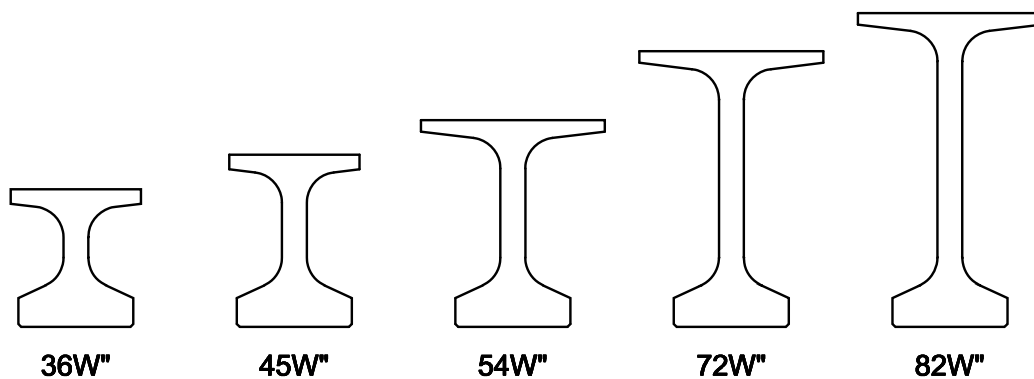

WisDOT Wide Flange Girder Shapes

Figure 19.3-7
I Girder Family Details

Table 19.3-1 and Table 19.3-2 provide span lengths versus interior girder spacings for HL-93 live loading on single-span and multiple-span structures for prestressed I-girder sections. Girder spacings are based on using low relaxation strands at $0.75f_{pu}$, a concrete haunch of 2", slab thicknesses from Chapter 17 – Superstructures - General and a future wearing surface. For these tables, a line load of 0.300 klf is applied to the girder to account for superimposed dead loads.

Several girder shapes have been retired from standard use on new structures. These include the following sizes; 45-inch, 54-inch and 70-inch. These girder shapes are used for girder replacements, widening and for curved new structures where the wide flange sections are not practical. See Chapter 40 – Bridge Rehabilitation for additional information on these girder shapes.

Due to the wide flanges on the 54W, 72W and 82W and the variability of residual camber, haunch heights frequently exceed 2". An average haunch of 2 1/2" was used for these girders in the following tables. **The haunch values currently used in all the tables are somewhat**



unconservative -- do not push the span limits/girder spacing during preliminary design. See [Table 19.3-2](#) for guidance regarding use of excessively long prestressed girders.

For interior prestressed concrete I-girders, 0.5" or 0.6" dia. strands (in accordance with the Standard Details).

f_c girder = 8,000 psi

f_c slab = 4,000 psi

Haunch height = 2" or 2 1/2"

Required f_c girder at initial prestress < 6,800 psi



Table of Contents

29.1 General2
29.2 Design Criteria3
29.3 Design Example9



29.1 General

Wherever practical, bridge drainage should be carried off the structure along the curb or gutter line and collected with roadway catch basins. Floor drains are not recommended for structures less than 400' long and floor drain spacing is not to exceed 500' on any structure. However, additional floor drains are required on some structures due to flat grades, superelevations and the crest of vertical curves. The drains are spaced according to the criteria as set forth in 29.2. It should be understood that it is acceptable for water to be on the shoulder, or even half the traveled lane at lower speeds, during extreme rain events. Additional drains should not be provided other than what is required by design. Utilizing blockouts in parapets to facilitate drainage is not allowed.

Superelevation on structures often creates drainage problems other than at the low point especially if a reverse curve is involved. Water collects and flows down one gutter and as it starts into the superelevation transition it spreads out over the complete width of roadway at the point of zero cross-slope. From this point the water starts to flow into the opposite gutter. Certain freezing conditions can cause traffic accidents to occur in the flat area between the two transitions. To minimize the problem, locate the floor drain as close to the cross over point as practical. Floor drains are installed as near all joints as practical to prevent gutter flow from passing over and/or through the joints.

The Bureau of Structures recommends the Type "GC" floor drain for new structures. Type "GC" floor drains are gray iron castings that have been tested for hydraulic efficiency. Steel fabricated floor drains Type "H" provide an additional 6" of downspout clearance. These are retained for maintenance of structures where floor drain size modifications are necessary.

All of the floor drains shown on the Standards have grate inlets. When the longitudinal grade exceeds 1 percent, hydraulic flow testing indicates grates with rectangular longitudinal bars are more efficient than grates having transverse rectangular bars normal to flow. However, grates with bars parallel to the direction of traffic are hazardous to bicyclists and even motorcyclists as bar spacing is increased for hydraulic efficiency. As a result, transverse bars sloped toward the direction of flow are detailed for the cast iron floor drains.

Downspouts are to be fabricated from galvanized standard pipe or reinforced fiberglass material having a diameter not less than 6". Downspouts are required on all floor drains to prevent water and/or chlorides from getting on the girders, bearings, substructure units, etc. Downspouts should be detailed to extend a minimum of 1' below low steel to prevent flange or web corrosion. A downspout collector system is required on all structures over grade separations. Reinforced fiberglass pipe is recommended for all collector systems due to its durability and economy. In the design of collector systems, elimination of unnecessary bends and provision for an adequate number of clean outs is recommended.



Table of Contents

36.1 General3
 36.1.1 Bridge or Culvert3
 36.1.2 Box Culvert Size Restrictions4
 36.1.3 Stage Construction for Box Culverts4
36.2 Dead Loads and Earth Pressure.....5
36.3 Live Loads.....6
 36.3.1 Concentrated Live Loads6
 36.3.2 Distributed Live Loads.....7
 36.3.3 Live Load Soil Pressures.....7
 36.3.4 Impact8
 36.3.5 Location for Maximum Moment.....8
36.4 Design Information.....9
36.5 Detailing of Reinforcing Steel.....11
 36.5.1 Corner Steel11
 36.5.2 Positive Moment Slab Steel12
 36.5.3 Negative Moment Steel over Interior Walls12
 36.5.4 Exterior Wall Positive Moment Steel13
 36.5.5 Interior Wall Moment Steel14
 36.5.6 Distribution Reinforcement.....14
 36.5.7 Temperature Reinforcement15
36.6 Box Culvert Aprons17
 36.6.1 Type A.....17
 36.6.2 Type B, C, D.....18
 36.6.3 Type E.....20
 36.6.4 Wingwall Design.....20
36.7 Box Culvert Camber.....21
 36.7.1 Computation of Settlement.....21
 36.7.2 Configuration of Camber22
 36.7.3 Numerical Example of Settlement Computation.....23
36.8 Box Culvert Structural Excavation and Structure Backfill24
36.9 Box Culvert Headers.....25
36.10 Construction Issues27



36.10.1 Weepholes27

36.10.2 Cutoff Walls27

36.10.3 Nameplate27

36.10.4 Plans Policy27

36.10.5 Rubberized Membrane Waterproofing27

36.11 Precast Box Culverts28

36.2 Dead Loads and Earth Pressure

The weight of soil above buried structures is taken as 120 pcf. For the lateral pressure from the soil an equivalent fluid unit weight of soil equal to 60 pcf is used.

When computing the maximum positive moment in the top and bottom exterior span, use an equivalent fluid unit weight of soil equal to 30 pcf and for multi-cell culverts when computing the maximum negative moment over the interior wall in the end cells.

Earth pressures or loads on culverts may be computed as the weight of earth directly above the structure. A load factor of 1.3 is used for vertical earth pressure and dead loads, and 1.69 (1.3 x 1.3) is used for lateral earth pressure. Vertical earth pressure is also multiplied by a soil structure interaction factor, F_e as stated in AASHTO 17.6.4.2.1. Embankment installations are always assumed.

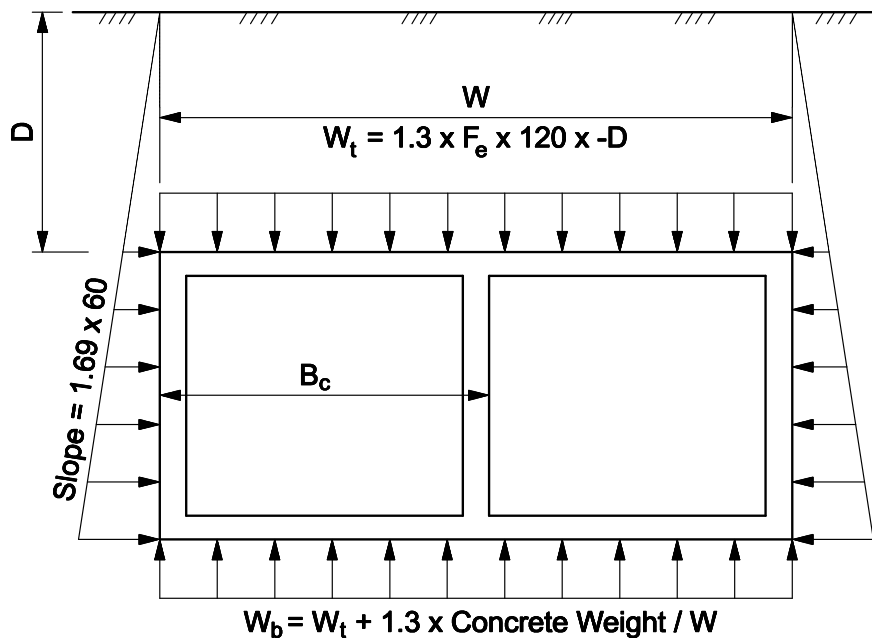

Figure 36.2-1
Vertical and Lateral Earth Pressures

Figure 36.2-1 shows the factored earth load pressures acting on a box culvert. The earth pressure from the dead load of the concrete is distributed equally over the bottom of the box. When designing the bottom slab of a culvert do not forget that the weight of the concrete in the bottom slab acts in an opposite direction than the bottom soil pressure and thus reduces the design moments and shears. See AASHTO 17.6.4 for values of F_e shown in figure.



36.3 Live Loads

Live load consists of the Standard AASHTO trucks. All culverts are designed for HS20 loading. When the depth of fill over the box is less than 2 feet the wheel load is distributed as in slabs with concentrated loads. When the depth of fill is 2 feet or more the concentrated wheel loads are uniformly distributed over a square, the sides of which are equal to 1.75 times the depth of fill. When areas from several concentrations overlap, the total load is considered as uniformly distributed over the area defined by the outside limits of the individual areas.

For distributed loads two trucks are placed side by side. For single cell boxes the effect of live load may be neglected when the depth of fill is more than 8 feet and exceeds the span length. For multiple cells it may be neglected when the depth of fill exceeds the distance between faces of end supports.

Assume that the truck passes over the box in a direction perpendicular to the centerline regardless of the culvert skew angle. The load factor for live load equals $1.3(5/3)(L + l)$.

36.3.1 Concentrated Live Loads

Distribute wheel load according to the formula:

$$E = 4 + 0.06S$$

Where:

- E = width of slab over which a wheel is distributed (ft)
- S = clear span of cell (ft)



36.4 Design Information

Sidesway of the box is not considered because of the lateral support of the soil.

Haunches at the center walls of multi-cell box culverts are not considered for analysis.

The centerline of the walls and top and bottom slabs are used for computing section properties and dimensions for analysis.

For skews of 20 degrees or less, culverts are analyzed as if the reinforcing steel is perpendicular to the centerline of box, even though the steel is actually placed along the skew. The only change is to the horizontal bar lengths which are increased in length by dividing by the cosine of the skew angle. For skews of over 20 degrees the reinforcing steel is placed perpendicular to the centerline of box.

Water pressure in culvert barrels is ignored.

Even though AASHTO Specifications require a stronger box for 2 feet of fill than 4 feet, design box culverts for the actual loading condition producing the stronger box. Do not anticipate future placing or removal of fill which may require a stronger box.

The minimum thickness of the top and bottom slab is 6 1/2 inches. Minimum wall thickness is based on the inside opening of the box (height) and the height of the apron wall above the floor. Use the following table to select the minimum wall thickness that meets or exceeds the three criteria in the table.

Minimum Wall Thickness (Inches)	Cell Height (Feet)	Apron Wall Height Above Floor (Feet)
8	< 6	< 6.75
9	6 to < 10	6.75 to < 10
10	10 to > 10	10 to < 11.75
11		11.75 to < 12.5
12		12.5 to 13

Table 36.4-1 Minimum Wall Thickness Criteria

All slab thicknesses are rounded to the next largest 1/2 inch.

All bar steel is detailed as being 2 inches clear except the bottom steel in the bottom slab. This steel is detailed as being 3 inches clear.

Top and bottom slab thicknesses are determined by shear and moment requirements. When calculating shear, live load is not considered. Slabs designed for bending moment based on the AASHTO wheel distribution are considered satisfactory in bond and shear.



A haunch is provided only when the slab depth required at the interior wall is more than 2 inches greater than that required for the remainder of the span. Minimum haunch depth is 3 inches and minimum length is 6 inches. Haunch depth is increased in 3 inch increments and haunch length is increased in 6 inch increments. The haunch length is not to exceed 7 times the depth.

Fatigue requirements in bar steel are satisfied by limiting the truck service load stress to AASHTO fatigue limits using working stress analysis. In addition to the truck live load, an equivalent fluid unit weight of soil equal to 30 pcf or 1/2 this value is added to the outside of the box. Vertical earth pressure and concrete dead load are not considered in the fatigue analysis. The fatigue stress limit for concrete usually does not govern. The AASHTO requirements for distribution of flexural reinforcement for crack control is not required. Cracking has not been a problem for culverts designed without considering it. Reinforced concrete design is based on the strength design method and *AASHTO Specifications*. Material strengths are:

Concrete - $f'_c = 3.5$ ksi

Bar Steel - $f_y = 60$ ksi

The slab thickness required is determined by moment or shear, whichever governs. Thickness based on moment is determined from using 37.5% of the reinforcement ratio producing balanced conditions.

The shear in the top and bottom slabs is assumed to occur at a distance "d" from the face of the walls. The value for "d" equals the distance from the centroid of the reinforcing steel to the face of the concrete in compression. When a haunch is used, shear must also be checked at the end of the haunch.

For multi-cell culverts make interior and exterior walls of equal thickness.

For culverts under high fills use a separate design for the ends if the reduced section may be used for at least two panel pours per end of culvert. Maximum length of panel pour is 40 feet.

Barrel lengths are based on the roadway sections and wing lengths are based on a 2 1/2:1 slope of fill from the top of box to apron.

Dimensions on drawings are given to the nearest 1/2 inch only.

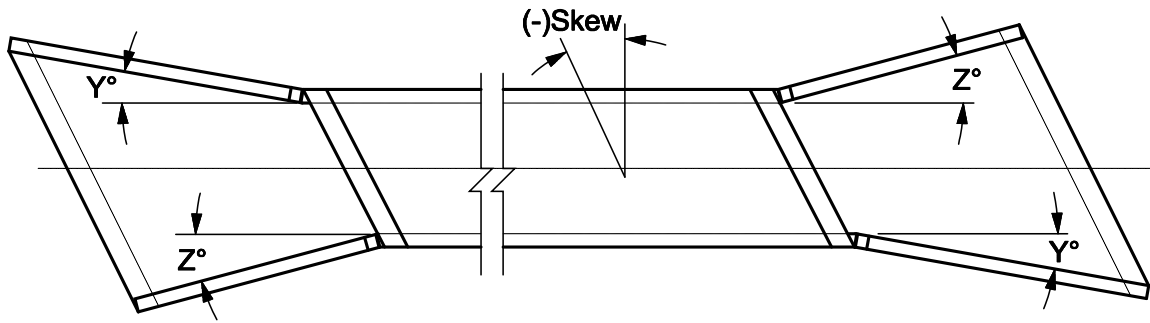

Skew		Wing Type B		Wing Type C		Wing Type D	
Greater Than	To Include	Angle Y	Angle Z	Angle Y	Angle Z	Angle Y	Angle Z
0°	7.5°	15°	15°	30°	30°	45°	45°
7.5°	15.0°	15°	15°	25°	30°	40°	45°
15.0°	22.5°	10°	15°	25°	30°	35°	45°
22.5°	37.5°	10°	15°	20°	30°	30°	45°
37.5°	45.0°	10°	15°	15°	30°	25°	45°
45.0°	52.5°	5°	15°	15°	30°	20°	45°
52.5°	67.5°	5°	15°	10°	30°	15°	45°
67.5°	75.0°	5°	15°	5°	30°	10°	45°
75.0°	82.5°	0°	15°	5°	30°	5°	45°
82.5°	90.0°	0°	15°	0°	30°	0°	45°

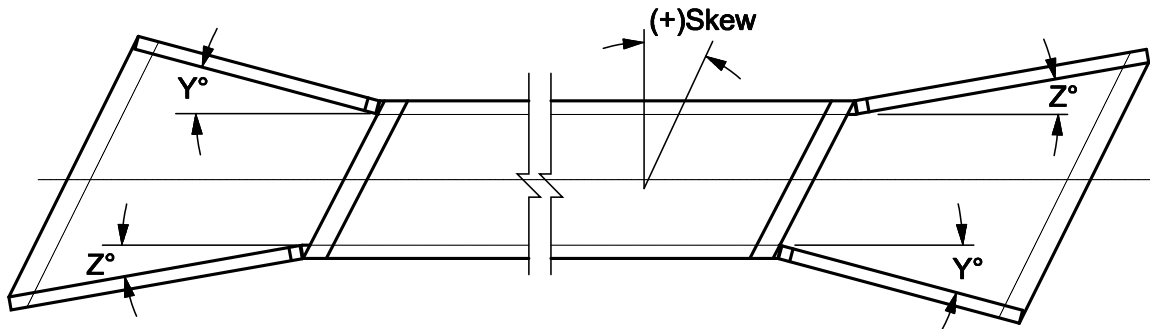

Skew		Wing Type B		Wing Type C		Wing Type D	
Greater Than	To Include	Angle Y	Angle Z	Angle Y	Angle Z	Angle Y	Angle Z
0°	7.5°	15°	15°	30°	30°	45°	45°
7.5°	15.0°	15°	15°	30°	25°	45°	40°
15.0°	22.5°	15°	10°	30°	25°	45°	35°
22.5°	37.5°	15°	10°	30°	20°	45°	30°
37.5°	45.0°	15°	10°	30°	15°	45°	25°
45.0°	52.5°	15°	5°	30°	15°	45°	20°
52.5°	67.5°	15°	5°	30°	10°	45°	15°
67.5°	75.0°	15°	5°	30°	5°	45°	10°
75.0°	82.5°	15°	0°	30°	5°	45°	5°
82.5°	90.0°	15°	0°	30°	0°	45°	0°

Figure 36.6-2
Wing Type B, C, D (Angles vs. Skew)



36.6.3 Type E

Type E is used primarily in urban areas where a sidewalk runs over the culvert and it is necessary to have a parapet and railing along the sidewalk. For Type E the wingwalls run parallel to the roadway just like the abutment wingwalls of most bridges. It is also used where Right of Way (R/W) is a problem and the aprons would extend beyond the R/W for other types. Wingwall lengths for Type E wings are based on a minimum channel slope of 1.5 to 1.

36.6.4 Wingwall Design

Culvert wingwalls are designed for an equivalent fluid unit weight of soil equal to 60 pcf and a 1 foot surcharge. Load Factor Design with a total load factor of 1.69 (1.3 x 1.3) is used. The lateral earth pressure was conservatively selected to keep wingwall deflection and cracking to acceptable levels. Many wingwalls that were designed for lower equivalent fluid unit weight of soil have experienced excessive deflections and cracking at the footing. This may expose the bar steel to the water that flows through the culvert and if the water is of a corrosive nature, corrosion of the bar steel will occur. This phenomena has lead to complete failure of some wingwalls throughout the State.

Even with the increased steel the higher wings still deflected around ¾ inches at the top. To prevent this (in 1998) 1 inch diameter dowel bars are added between the wing and box wall for culverts over 6 feet high. The dowels have a bond breaker on the portion that extends into the wings.

For wing heights of 7 feet or less determine the area of steel required by using the maximum wall height and use the same bar size and spacing along the entire wingwall length. The minimum amount of steel used is #4 bars at 12 inch spacing. Wingwall thickness is made equal to the barrel wall thickness.

For wing heights over 7 feet the wall length is divided into two or more segments and the area of steel is determined by using the maximum height of each segment. Use the same bar size and spacing in each segment.

Shrinkage and temperature reinforcement shall be used on the front face of all wingwalls.



Table of Contents

37.1 Structure Selection.....2
37.2 Specifications and Standards3
37.3 Protective Screening.....5



37.1 Structure Selection

Most pedestrian bridges are located in urban areas and carry pedestrian and/or bicycle traffic over divided highways, expressways and freeway systems. The structure type selected is made on the basis of aesthetics and economic considerations. A wide variety of structure types are available and each type is defined by the superstructure used. Some of the more common types are as follows:

- Concrete Slab
- Prestressed Concrete Girder
- Steel Girder
- Prefabricated Truss

Several pedestrian bridges are a combination of two structure types such as a concrete slab approach span and steel girder center spans. One of the more unique pedestrian structures in Wisconsin is a cable stayed bridge. This structure was built in 1970 over USH 41 in Menomonee Falls. It is the first known cable stayed bridge constructed in the United States. Generally, pedestrian bridges provide the designer the opportunity to employ long spans and medium depth sections to achieve a graceful structure.

Pedestrian boardwalks will not be considered “bridges” when their clear spans are less than or equal to 20 feet, and their height above ground and/or water is less than 10 feet. Boardwalks falling under these constraints will not be required to follow the design requirements in the WisDOT Bridge Manual, but will need to follow the standards established in the *Wisconsin Bicycle Facility Design Handbook*.



37.2 Specifications and Standards

The designer shall refer to the following related specifications:

- "AASHTO LRFD Bridge Design Specifications"
- "AASHTO LRFD Guide Specifications for the Design of Pedestrian Bridges", hereafter referred to as the "Pedestrian Bridge Guide"
- See *Standardized Special Provision (STSP)* titled "Prefabricated Steel Truss Pedestrian Bridge" for the requirements for this bridge type

For additional design information, refer to the appropriate Wisconsin Bridge Manual chapters relative to the structure type selected.

The pedestrian live load (PL) shall be as follows: (from "Pedestrian Bridge Guide")

- 90 psf **[Article 3.1]**
- Dynamic load allowance is not applied to pedestrian live loads **[Article 3.1]**

The vehicle live load shall be applied as follows: (from "Pedestrian Bridge Guide")

- Design for an occasional single maintenance vehicle live load (LL) **[Article 3.2]**

Clear Bridge Width (w)	Maintenance Vehicle
$7 \text{ ft} \leq w \leq 10 \text{ ft}$	H5 Truck (10,000 lbs)
$w > 10 \text{ ft}$	H10 Truck (20,000 lbs)

- Clear bridge widths of less than 7 feet need not be designed for maintenance vehicles. **[Article 3.2]**
- The maintenance vehicle live load shall not be placed in combination with the pedestrian live load. **[Article 3.2]**
- Dynamic load allowance is not applied to the maintenance vehicle. **[Article 3.2]**
- Strength I Limit State shall be used for the maintenance vehicle loading. **[Article 3.2, 3.7]**

On Federal Aid Structures FHWA requests a limiting gradient of 8.33 percent (1:12) on ramps for pedestrian facilities to accommodate the physically handicapped and elderly as recommended by the "American Standard Specifications for Making Buildings and Other Facilities Accessible to, and Usable by, the Physically Handicapped". This is slightly flatter than the gradient guidelines set by AASHTO which states gradients on ramps should not be more than 15 percent and preferably not steeper than 10 percent.

The minimum inside clear width of a pedestrian bridge on a pedestrian accessible route is 8 feet. (AASHTO Guide for the Planning, Design, and Operation of Pedestrian Facilities, 2004).



The width required is based on the type, volume, and direction of pedestrian and/or bicycle traffic.

In addition, ramps should have rest areas or landings 5 feet to 6 feet in length which are level and safe. Rest area landings are mandatory when the ramp gradient exceeds 5 percent. Recommendations are that landings be spaced at 60 foot maximum intervals, as well as wherever a ramp turns. This value is based on a maximum gradient of 8.33 percent on pedestrian ramps, and placing a landing at every 5 feet change in vertical elevation. Also, ramps are required to have handrails on both sides. See Standard Details for handrail location and details.

Minimum vertical clearance for a pedestrian overpass can be found in the *Facilities Development Manual (FDM)* Procedure 11-35-1, Attachment 8 and 9. Horizontal clearance is provided in accordance with the requirement found in *(FDM)* Procedure 11-35-1, Attachment 5 and 6..

Live load deflection limits shall be in accordance with the provisions of **LRFD [2.5.2.6.2]** for the appropriate structure type.



37.3 Protective Screening

Protective Screening is recommended on all pedestrian overpasses due to the increased number of incidents where objects were dropped or thrown onto vehicles traveling below. Several types of screening material are available such as aluminum, fiberglass and plastic sheeting, and chain link type fencing. A study of the various types of protective screening available indicates that chain link fencing is the most economical and practical for pedestrian overpasses. For recommended applications refer to the Standard Details.

The top of the protective screening is enclosed with a circular section in order to prevent objects from being thrown over the sides and to discourage children from climbing on the top. The opening at the bottom is held at a 1 inch clearance to prevent objects from being pushed under the fence.

The core wire of the fence fabric shall be a minimum of 9 gauge (0.148 inch) thickness, galvanized and woven in a 2 inch mesh. A 1 inch mesh may be used in highly vulnerable areas. A vinyl coating may also be used for aesthetic purposes. Add a special provision to the contract if these additional features are used. Special provisions for common items are available as STSP's or on the Wisconsin Bridge Manual website.



This page intentionally left blank.



Table of Contents

40.1 General3

40.2 History4

 40.2.1 Concrete.....4

 40.2.2 Steel4

 40.2.3 General4

40.3 Bridge Replacements.....5

40.4 Rehabilitation Considerations6

40.5 Deck Overlays.....9

 40.5.1 Guidelines for Bridge Deck Overlays9

 40.5.2 Deck Overlay Methods10

 40.5.3 Maintenance Notes11

 40.5.4 Special Considerations.....11

40.6 Deck Replacements.....12

40.7 Rehabilitation Girder Sections13

40.8 Widening15

40.9 Superstructure Replacements/Moved Girders (with Widening)16

40.10 Replacement of Impacted Girders17

40.11 New Bridge Adjacent to Existing Bridge18

40.12 Timber Abutments.....19

40.13 Survey Report and Miscellaneous Items20

40.14 Superstructure Inspection22

 40.14.1 Prestressed Girders22

 40.14.2 Steel Beams23

40.15 Substructure Inspection25

 40.15.1 Hammerhead Pier Rehabilitation25

 40.15.2 Bearings26

40.16 Concrete Masonry Anchors for Rehabilitation27

40.17 Plan Details30

40.18 Retrofit of Steel Bridges32

 40.18.1 Flexible Connections32

 40.18.2 Rigid Connections32

40.19 References.....33



40.20 Reinforcing Steel for Deck Slabs on Girders for Deck Replacements34



- Combined distress area is less than 25%.
- May require crack sealing the following year and periodically thereafter.

* Note: Or another PC concrete product as approved by Structures Development and coordinated with the Region.

40.5.3 Maintenance Notes

- All concrete overlays crack immediately. If the cracks in the deck are not sealed periodically, the rate of deterioration can increase rapidly.
- AC overlays with a waterproofing membrane can also be used on new decks or older decks that are in good condition as preventive maintenance.

40.5.4 Special Considerations

On continuous concrete slab bridges with extensive spalling in the negative moment area, not more than 1/3 of the top bar steel should be exposed if the bar ends are not anchored. This is to maintain the continuity of the continuous spans and should be stated on the final structure plans.

If more than 1/3 of the steel is exposed, either the centers of adjacent spans must be shored or only longitudinally overlaying 1/3 of the bridge at a time.



40.6 Deck Replacements

Depending on the structure age or site conditions, the condition of original deck or deck overlay, a complete deck replacement may be the most cost effective and extend the life of the bridge by 40 years or more. Epoxy coated rebars are required on bridge deck replacements under the same criteria as for new bridges. The new deck and parapet or railing shall be designed per the most recent edition of the WisDOT Bridge Manual, including continuity bars and overhang steel. Refer to the criteria in 40.3 of this chapter for additional 3R project considerations. The top flange of steel girders should be painted.

The following condition or rating criteria are the minimum requirements on STN bridges eligible for deck replacements:

Item	Existing Condition	Condition after Construction
Deck Condition	≤ 4	≥ 8
Inventory Rating	≥ HS15	≥ HS15
Superstructure Condition	≥ 3	≥ 8
Substructure Condition	≥ 3	≥ 8
Horizontal and Vertical Alignment Condition	> 3	---
Shoulder Width	6 ft	6 ft

Table 40.6-1 Condition Requirements for Deck Replacements

When the structure is a continuous steel girder bridge and meets criteria for deck replacement, but has an Inventory Rating less than HS10, a bridge replacement is recommended. On all Interstate Highway deck replacements, the bridges are to have a minimum Inventory Rating of HS20, after the deck is replaced.

For slab superstructure replacements on concrete pier columns, it is reported that the columns often get displaced and/or cracked during removal of the existing slab. Plans should be detailed showing full removal of these pier columns to the existing footing and replacement with current standard details showing a concrete cap with pier columns or shaft.

See the Facilities Development Manual for anchorage/offset requirements for temporary barrier used in staged construction.

In general, the substructure need not be analyzed for additional dead load provided the new deck is comparable to the existing. Exceptions include additional sidewalk or raised medians that would significantly alter the dead load of the superstructure.

For prestressed girder deck replacements, only use intermediate steel diaphragms in locations of removed intermediate concrete diaphragms (i.e. don't add intermediate lines of diaphragms).



40.7 Rehabilitation Girder Sections

WisDOT BOS has retired several girder shapes [from standard use on new structures](#). The 45", 54" and 70" girder sections shall be used primarily for bridge rehabilitation projects such as girder replacements or widening.

These sections may also be used on a limited basis on new curved structures when the overhang requirements cannot be met with the wide-flange girder sections. These sections employ draped strand patterns with undraped alternates where feasible. Undraped strand patterns, when practical, should be specified on the designs. See the Standard Details for the girder sections' draped and undraped strand patterns.

The 45", 54", and 70" girders in Chapter 40 standards have been updated to include the proper non-prestressed reinforcement so that these sections are LRFD compliant. [Table 40.7-1](#) provides span lengths versus interior girder spacings for HL-93 live loading on single-span and multiple-span structures for prestressed I-girder rehabilitation sections. Girder spacing and span lengths are based on the following criteria:

- Interior girders with low relaxation strands at $0.75f_{pu}$,
- A concrete haunch of 2 1/2",
- Slab thicknesses from Chapter 17 – Superstructures - General
- A future wearing surface of 20 psf.
- A line load of 0.300 klf is applied to the girder to account for superimposed dead loads.
- 0.5" or 0.6" dia. strands (in accordance with the Standard Details).
- f'_c girder = 8,000 psi
- f'_c slab = 4,000 psi
- Haunch height = 2" or 2 1/2"
- Required f'_c girder at initial prestress < 6,800 psi



45" Girder		
Girder Spacing	Single Span	2 Equal Spans
6'-0"	102	112
6'-6"	100	110
7'-0"	98	108
7'-6"	96	102
8'-0"	94	100
8'-6"	88	98
9'-0"	88	96
9'-6"	84	90
10'-0"	84	88
10'-6"	82	86
11'-0"	78	85
11'-6"	76	84
12'-0"	70	80

54" Girder		
Girder Spacing	Single Span	2 Equal Spans
6'-0"	130	138
6'-6"	138	134
7'-0"	124	132
7'-6"	122	130
8'-0"	120	128
8'-6"	116	124
9'-0"	112	122
9'-6"	110	118
10'-0"	108	116
10'-6"	106	112
11'-0"	102	110
11'-6"	100	108
12'-0"	98	104

70" Girder		
Girder Spacing	Single Span	2 Equal Spans
6'-0"	150*	160*
6'-6"	146*	156*
7'-0"	144*	152*
7'-6"	140*	150*
8'-0"	138*	146*
8'-6"	134*	142*
9'-0"	132*	140*
9'-6"	128*	136
10'-0"	126*	134
10'-6"	122	132
11'-0"	118	128
11'-6"	116	126
12'-0"	114	122

Table 40.7-1
Maximum Span Length vs. Girder Spacing

* For lateral stability during lifting these girder lengths will require pick up point locations greater than distance d (girder depth) from the ends of the girder. The designer shall assume that the pick up points will be at the 1/10 points from the end of the girder and provide extra non-prestressed steel in the top flange if required.



40.8 Widening

Deck widenings, except on the Interstate, are attached to the existing decks if they are structurally sound and the remaining width is more than 50 percent of the total new width. Also, reference is made to the criteria in 40.3 of this Chapter for additional 3R project considerations. If the existing deck is over 20 percent surface delaminated or spalled, the existing deck shall be replaced. For all deck widenings on Interstate Highway bridges, the total deck should be replaced in order that total deck life is equal and costs are likely to be less when considering future traffic control. Evaluate the cost of traffic control for deck widenings on other highway bridges. The total deck should be replaced in these cases where the life-cycle cost difference is minimal if future maintenance costs are substantially reduced.

The design details must provide a means of moment and shear transfer through the joint between the new and existing portions of the deck. Lapped reinforcing bars shall have adequate development length and are preferable to doweled bars. The reinforcing laps must be securely tied or the bars joined by mechanical methods. When practical, detail lapped rebar splices. Mechanical splice couplers or threaded rebar couples are expensive and should only be detailed when required. Generally, shear transfer is more than sufficient without a keyway. Bridge Maintenance Engineers have observed that if the existing bar steel is uncoated, newly lapped coated bars will accelerate the uncoated bar steel deterioration rate.

When widening a deck on a prestressed girder bridge, if practical, use the latest standard shape (e.g. 54W" rather than 54"). Spacing the new girder(s) to maintain comparable bridge stiffness is desirable. *The girders used for widenings may be the latest Chapter 19 sections designed to LRFD or the sections from Chapter 40 designed LFD, or LRFD with non-prestressed reinforcement as detailed in the Standard Details.*

For multi-columned piers, consider the cap connection to the existing cap as pinned and design the new portion to the latest LRFD criteria. The new column(s) are not required to meet AASHTO 3.6.5 (400 kip loading) as a widening is considered rehabilitation. *It is intended to provide standard details in the Bridge Manual for a crash barrier that could, at the option of the Region, be used to strengthen and provide motorists protection for existing piers, including widenings.*

Abutments shall be widened to current LRFD criteria as well as the Standard for Abutment Widening.

For foundation support, use the most current method available.

All elements of the widening shall be designed to current LRFD criteria. Railings and parapets placed on the new widened section shall be up to current design and safety standards.

For prestressed girder widenings, only use intermediate steel diaphragms in-line with existing intermediate diaphragms (i.e. don't add intermediate lines of diaphragms).



40.9 Superstructure Replacements/Moved Girders (with Widening)

When steel girder bridges have girder spacings of 3' or less and require expensive redecking or deck widening; consider replacing the superstructure with a concrete slab. Approval is required from BOS for all Superstructure replacement projects. Also, additional costs will occur if bearings, floor drains, expansion joints, railings, or other structural elements require replacement.

When replacing a deck on a steel girder bridge, the cost of painting and structural rehab shall be considered to determine whether a deck or superstructure replacement is more cost effective (provided the substructure is sufficient to support the loading).

Evaluate the piers using current LRFD criteria, including the 400 kip impact loading. Unlike widenings, this evaluation is required since the entire superstructure is being replaced. It is unlikely that many piers could be re-used for this category of rehabilitation.

For abutments, evaluate the piles, or bearing capacity of the ground if on spread footings, utilizing Service I loading. The abutment body should be evaluated using Strength I loading.

The superstructure shall be design to current LRFD criteria.



40.12 Timber Abutments

The use of timber abutments shall be limited to rehabilitation or widening of off-system structures.

Timber abutments consist of a single row of piling capped with timber or concrete, and backed with timber to retain the approach fill. The superstructure types are generally concrete slab or timber. Timber-backed abutments currently exist on Town Roads and County Highways where the abutment height does not preclude the use of timber backing.

Piles in bents are designed for combined axial load and bending moments. For analysis, the assumption is made that the piles are supported at their tops and are fixed 6 feet below the stream bed or original ground line. For cast-in-place concrete piling, the concrete core is designed to resist the axial load. The bending stress is resisted by the steel shell section. Due to the possibility of shell corrosion, steel reinforcement is placed in the concrete core equivalent to a 1/16-inch steel shell perimeter section loss. The reinforcement design is based on equal section moduli for the two conditions. Reinforcement details and bearing capacities are given on the Standard Detail for Pile Details. Pile spacing is generally limited to the practical span lengths for timber backing planks.

The requirements for tie rods and deadmen is a function of the abutment height. Tie rods with deadmen on body piling are used when the height of "freestanding" piles is greater than 12 feet for timber piling and greater than 15 feet for cast-in-place concrete and steel "HP" piling. The "freestanding" length of a pile is measured from the stream bed or berm to grade. If possible, all deadmen should be placed against undisturbed soil.

Commercial grade lumber as specified in AASHTO having a minimum flexural resistance of 1.2 ksi is utilized for the timber backing planks. The minimum recommended nominal thickness and width of timber backing planks are 3 and 10 inches, respectively. If nominal sizes are specified on the plans, analysis computations must be based on the dressed or finished sizes of the timber. Design computations can be used on the full nominal sizes if so stated on the bridge plans. For abutments constructed with cast-in-place concrete or steel "HP" piles, the timber planking is attached with 60d common nails to timber nailing strips which are bolted to the piling.



40.13 Survey Report and Miscellaneous Items

Prior to scheduling bridge plans preparation, a Rehabilitation Structure Survey Report Form is to be completed for the proposed work with field and historical information. The Rehabilitation Structure Survey Report provides the Bridge Engineer pertinent information such as location, recommended work to be performed, and field information needed to accomplish the rehabilitation plans. A brief history of bridge construction date, type of structure, repair description and dates are also useful in making decisions as to the most cost effective rehabilitation. Along with this information, it is necessary to know the extent of deck delamination and current deck, super and substructure condition ratings. A thorough report recommending structural repairs and rehabilitation with corresponding notes is very useful for the designer including information from special inspections.

Because new work is tied to existing work, it is very important that accurate elevations be used on structure rehabilitation plans involving new decks and widenings. Survey information of existing beam seats is essential. Do not rely on original plans or a plan note indicating that it is the responsibility of the contractor to verify elevations.

Experience indicates that new decks open to traffic and subjected to application of de-icing salts within the first year show signs of early deck deterioration. Therefore, a protective surface treatment is applied to all new bridge deck concrete as given in the special provisions.

For existing sloped faced parapets on decks under rehabilitation, the metal railings may be removed. On deck replacements and widenings, all existing railings are replaced. Refer to Bridge Manual Chapter 30 for recommended railings.

On rehabilitation plans requiring removal of the existing bridge name plates; provide details on the plans for new replacement name plates if the existing name plate cannot be reused. The existing bridge number shall be used on the name plates for bridge rehabilitation projects.

If floor drain removal is recommended, review these recommendations for conformance to current design standards and remove any floor drains not required. Review each structure site for length of structure, grade, and water erosion at the abutments.

Bridge rehabilitation plans for steel structures are to provide existing flange and web sizes to facilitate selecting the proper length bolts for connections. If shear connectors are on the existing top flanges, additional shear connectors are not to be added as welding to the top flange may be detrimental. Do not specify any aluminized paint that will come in contact with fresh concrete. The aluminum reacts severely with the fresh concrete producing concrete volcanoes.

Existing steel expansion devices shall be modified or replaced with Watertight Expansion Devices as shown in Bridge Manual Chapter 28. If the hinge is repaired, consideration should be given to replacing the pin plates with the pins. Replace all pins with stainless steel pins conforming to ASTM 276, Type S20161 or equal. On unpainted steel bridges, the end 6' or girder depth, whichever is greater, of the steel members adjacent to an expansion joint and/or hinge are required to have two shop coats of paint. The second coat is to be a brown



color similar to rusted steel. Exterior girder faces are not painted for aesthetic reasons, but paint the hanger on the side next to the web.

A bridge on a steep vertical grade may slide down hill closing any expansion joint on this end and moving the girders off center from the bearings. One possible corrective action is to block the ends of the girder during the winter when the girders have shortened due to cold temperatures. Continued blocking over a few seasons should return the girders to the correct position. The expansion device at the upslope end may have to be increased in size.

Raised pavement markers require embedment in the travel way surface. As a general rule, they are not to be installed on bridge decks due to future leakage problems if the marker comes out. They shall not be installed thru the membranes on asphalt overlays and not at all on asphaltic decks where the waterproofing is integral with the surface.



40.14 Superstructure Inspection

40.14.1 Prestressed Girders

On occasion prestressed concrete girders are damaged during transport, placement, or as a result of vehicle impact. Damage inspection and assessment procedures are necessary to determine the need for traffic restrictions, temporary falsework for safety and/or strength. Three predominant assessment areas are damage to prestressing strands, damage to concrete, and remaining structural integrity.

Where damage to a girder results in any significant loss of concrete section, an engineering analysis should be made. This analysis should include stress calculations for the damaged girder with comparison to the original design stresses. These calculations will show the loss of strength from the damage.

Assessment of damage based on the loss of one or more prestressing strands or loss of prestress force is given as reason for restriction or replacement of girders. Some of the more common damages are as follows with the recommended maintenance action. However, an engineering assessment should be made on all cases.

1. If cracking and spalling are limited to the lower flange, patching is usually performed. This assessment should be based on calculations that may allow repair.
2. If cracking continues from flange into web, the girder is normally replaced. Findings indicate that sometimes repair-in-place may be the preferred decision.
3. Termini of cracks are marked, and if the cracks continue to grow the girder may be replaced. This is a good method to determine the effect of loads actually being carried.
4. When large areas of concrete are affected, or when concrete within stirrups is fractured, replace. At times it may be more appropriate to repair-in-place than replace.

Repair and/or replacement decisions are based on structural integrity. Load capacity is by far the most important rationale for selection of repair methods. Service load capacity needs to be calculated if repair-in-place is contemplated.

Evaluations of criteria for assessment of damage related to the two predominant areas associated with structural integrity are the following:

1. A structural analysis is made to determine the stresses in a damaged girder on the basis of the actual loads the girder will carry. This technique may result in a girder that has less capacity than the original, but can still safely carry the actual loads. This assessment results in consideration of possible repair-in-place methods which normally are cost effective.

or



BID ITEM: CONCRETE MASONRY ANCHORS, TYPE S, NO. 5 BAR. Add the following note to plan for anchored rebars: UNDER THE BID ITEM “CONCRETE MASONRY ANCHORS, TYPE S, ANCHORED REINFORCING STEEL SHALL BE PAID FOR SEPARATELY AS PROVIDED IN SECTION 505 OF THE STANDARD SPECIFICATIONS FOR BAR STEEL REINFORCEMENT”.

BID ITEM: CONCRETE MASONRY ANCHORS, TYPE S, 5/8 INCH

Use the above bid item for anchoring bolts or studs. The bolt, nut, and washer or the stud as detailed on the plans is included in the bid item.

Bar Size	Cartridge Diameter in	Hole Diameter In	Grouted Length Using One 12” Cartridge In	*Basic Tens, Development Length In
#6	0.9	1.0	22.2	18
#7	1.125	1.25	18.9	24
#8	1.125	1.25	26.7	32
#8	1.375	1.625	13.8	32
#9	1.375	1.625	16.5	40
#10	1.375	1.625	20.9	51
#10	1.5625	1.75	19.5	51
#11	1.5625	1.75	24.8	63
#11	1.5625	1.875	18.0	63

*From AASHTO LRFD, 5.11.2, $f_c' = 3.5$ ksi

Table 40.16-2

Design Table for Concrete Masonry Anchors, Type L

Specify on the Bridge Plans: CONCRETE MASONRY ANCHOR, TYPE L, NO. 9 BAR, EMBED 3'-4”.

To develop the ultimate bar strength a minimum embedment length equal to the development length is required. The contractor will determine the hole size and number of cartridges. Minimum hole diameter shall be as recommended by the manufacturer of the Type L anchor being used. For number 8 bars and smaller, hole diameter is usually ¼ inch greater than bar size.

BID ITEM: CONCRETE MASONRY ANCHORS, TYPE L, NO. 9 BARS

Note: For “Type L” and “Type S” masonry anchors anchoring rebars the reinforcing bar is listed in the “Bill of Bars” and its weight included in the quantities.



40.17 Plan Details

1. Excavation for Structures on Overlays

There is considerable confusion on when to use or not use the bid item "Excavation for Structures" on overlay projects. In order to remove the confusion the following note is to be added to all overlay projects that only involve removal of the paving block or less.

Any excavation required to complete the overlay or paving block at the abutments is to be considered incidental to the bid item "Concrete Masonry Overlay Decks".

If the overlay project has any excavation other than the need to replace a paving block or prepare the end of the deck for the overlay the "Excavation" bid item should be used and the above note left off the plan.

2. For steel girder bridge deck replacements; show the existing exterior girder size including the lower flange size on the plans to assist the contractor in ordering falsework brackets.

3. On structure deck overlay projects:

Verify desired transverse or roadway cross slopes with Regions considering the changes in bridge rating and approach pavement grade. Although relatively flat by today's standard of an 0.02'/' cross slope; a cross slope of 0.01'/'/0.015'/' may be the most desirable.

The designer should evaluate 3 types of repairs. (Preparation Decks Type 1) is concrete removal to the top of the bar steel. (Preparation Decks Type 2) is concrete removal below the bar steel. (Full Depth Deck Repair) is full depth concrete removal and repair. The designer should compute the quantity and cost for each type and a total cost. Compare the total cost to the estimated cost of a deck replacement and proceed accordingly. Show the location of (Full Depth Deck Repair) on the plan sheet.

Contractors have gotten projects where full depth concrete removal was excessive and no locations designated. It would have been a better decision to replace the deck.

4. When detailing two stage concrete deck construction; consider providing pier cap construction joints to coincide with the longitudinal deck construction joint. Also, transverse deck bar steel lap splicing is preferred over the use of bar couplers. This is applicable where there is extra bridge width and the falsework can be left for both deck pours.

5. Total Estimated Quantities

For all Bituminous Material Overlays:



Table of Contents

45.1 General3

45.2 Bridge Inspections4

 45.2.1 Condition of Bridge Members.....4

45.3 Load Rating Methodologies6

 45.3.1 General Assumptions.....6

 45.3.2 Load and Resistance Factor Rating (LRFR) Method7

 45.3.2.1 Limit States.....10

 45.3.2.2 Load Factors.....10

 45.3.2.3 Resistance Factors.....11

 45.3.2.4 Condition Factor: ϕ_C11

 45.3.2.5 System Factor: ϕ_S11

 45.3.2.6 Design Load Rating12

 45.3.2.6.1 Design Load Rating Live Load.....12

 45.3.2.7 Legal Load Rating12

 45.3.2.7.1 Legal Load Rating Live Load12

 45.3.2.7.2 Legal Load Rating Load Posting Equation.....12

 45.3.2.8 Permit Load Rating.....13

 45.3.2.8.1 Permit Load Rating Live Load.....13

 45.3.3 Load Factor Rating (LFR) Method.....13

 45.3.3.1 Live Loads14

 45.3.3.2 Load Factors.....14

45.4 Bridge Posting.....16

 45.4.1 Posting Live Loads.....20

 45.4.2 Posting Signage22

45.5 Material Strengths and Properties23

 45.5.1 Reinforcing Steel.....23

 45.5.2 Concrete.....23

 45.5.3 Prestressed Steel Strands.....24

 45.5.4 Structural Steel.....25

45.6 Wisconsin Standard Permit Vehicle Design Check26

45.7 Overweight Trip Permits27

 45.7.1 General Information.....27



45.7.2 Annual Trip Permit Information.....27

45.7.3 Single Trip Permit Information.....28

45.8 Load Rating Documentation29

45.8.1 Load Rating Summary Sheet29

45.8.2 Load Rating on Plans.....29

45.9 Standard Permit Vehicle Moments32

45.10 References.....34

45.11 Rating Examples.....35



45.3.2.8 Permit Load Rating

This level of load rating serves many purposes for WisDOT. First, it is the level of load rating analysis required for all structures when performing the Wisconsin Standard Permit Vehicle Design Check as illustrated in 45.6. Second, this level is used, whenever necessary, for issuance of Single Trip permits. As their name indicates, single trip permits are valid for only one trip. Each single trip permit vehicle is analyzed for every structure it will cross.

45.3.2.8.1 Permit Load Rating Live Load

For any bridge design (new or rehabilitation) or bridge re-rate, the Wisconsin Standard Permit Vehicle (Wis-SPV) shall be analyzed (Figure 45.6-1). Specifics on this analysis can be found in 45.6.

For specific Single Trip permit applications, the actual truck configuration described in the permit shall be the live load used to analyze all pertinent structures.

WisDOT policy items:

WisDOT interpretation of **LRFR [6.4.5.4.1]** is for spans up to 200'-0", only the permit vehicle shall be considered present in the lane. For spans 200'-0" in length or greater an additional lane load shall be applied to simulate closely following vehicles. The lane load shall be taken as 0.2 klf in each lane and shall only be applied to those portions of the span(s) where the loading effects add to the permit load effects.

Also note, as stated in the footnote of **LRFR [Table 6-6]**, when using a single-lane LRFD distribution factor, the 1.2 multiple presence factor should be divided out from the distribution factor equations.

45.3.3 Load Factor Rating (LFR) Method

All bridge structures designed utilizing LFD or ASD shall be rated utilizing LFR per the 2003 AASHTO *Manual for Condition Evaluation and Load and Resistance Factor Rating (LRFR) of Highway Bridges (LRFR [Appendix D.6.1])*. The basic rating equation can be found in **LRFR [Equation D6.1]** and is:

$$RF = \frac{C - A_1 D}{A_2 (L + I)}$$

Where:

RF = Rating Factor

C = Capacity

D = The dead load effect on the member.



- L = The live load effect on the member
- I = The impact factor to be used with the live load effect
- A₁ = Load Factor for Dead Load
- A₂ = Load Factor for Live Load

45.3.3.1 Live Loads

Similar to LRFR, there are three potential checks to be made in LFR that are detailed in the flow chart shown in [Figure 45.3-2](#). For purposes of calculating the Inventory and Operating rating of the structure, the live load to be used should be the HS20 truck or lane loading as shown in Figures 17.2-1 and 17.2-3. For conducting the Wisconsin Standard Permit Vehicle Design Check, use the loading shown in [Figure 45.6-1](#). For determination of postings, refer to [45.4.1](#) for the proper posting vehicles.

One important item to note: when rating permit loads for continuous concrete slab bridges of 30'-0" width or more wheel loads are distributed over a width of 12'-0", which is a simplified adaptation of the distribution factor in the Ontario Bridge Design Code.

45.3.3.2 Load Factors

See [Table 45.3-5](#) for load factors to be used when rating with the LFR method. The nominal capacity C is the same regardless of the rating level desired.

LFR Live Load Factors		
Rating Level	A ₁	A ₂
Inventory	1.3	2.17
Operating	1.3	1.3

Table 45.3-5
LFR Live Load Factors



$$V_{190LLIM} := V_{190LL} \cdot g_v \cdot 2 \cdot 1.33$$

$$V_{190LLIM} = 150 \text{ kips}$$

$$RF_{190_shear} := \frac{(1)(1)(0.9) V_n - 1.25 \cdot (V_{DCnc} + V_{DCc})}{1.3(V_{190LLIM})}$$

$$RF_{190_shear} = 0.999$$

$$Wt := RF_{190_shear} \cdot 190$$

$$Wt = 190$$

E45-2.12 Summary of Rating Factors

Interior Girder							
Limit State		Design Load Rating		Legal Load Rating	Permit Load Rating (kips)		
		Inventory	Operating		Single Lane w/ FWS	Single Lane w/o FWS	Multi Lane w/o FWS
Strength I	Flexure	1.723	2.233	N/A	465	494	325
	Shear	1.11	1.439	N/A	216	233	190
Service III		1.43	N/A	N/A	N/A	N/A	N/A
Service I		N/A	N/A	N/A	Optional	Optional	Optional



This page intentionally left blank.



Table of Contents

E45-3 Two Span 54W" Prestressed Girder Bridge Continuity Reinforcement, LRFD Design, Rating

Example LRFR 2

- E45-3.1 Design Criteria..... 2
- E45-3.2 Modulus of Elasticity of Beam and Deck Material 3
- E45-3.3 Section Properties 3
- E45-3.4 Girder Layout..... 4
- E45-3.5 Loads..... 4
 - E45-3.5.1 Dead Loads 4
 - E45-3.5.2 Live Loads 5
- E45-3.6 Load Distribution to Girders..... 5
 - E45-3.6.1 Distribution Factors for Interior Beams: 6
- E45-3.8 Dead Load Moments 7
- E45-3.9 Live Load Moments 7
- E45-3.10 Composite Girder Section Properties..... 8
- E45-3.11 Flexural Strength Capacity at Pier.....10
- E45-3.12 Design Load Rating11
- E45-3.13 Permit Load Rating.....11
- E45-3.14 Summary of Rating Factors.....13



E45-3 Two Span 54W" Prestressed Girder Bridge - Continuity Reinforcement, LRFD Design, Rating Example - LRFR

This example will perform the LRFR rating calculations for the bridge that was designed in Chapter 19 of this manual (E19-2). Though it is necessary to rate both the interior and exterior girders to determine the minimum capacity, this example will analyze the interior girder only in the negative moment region (continuity reinforcement).

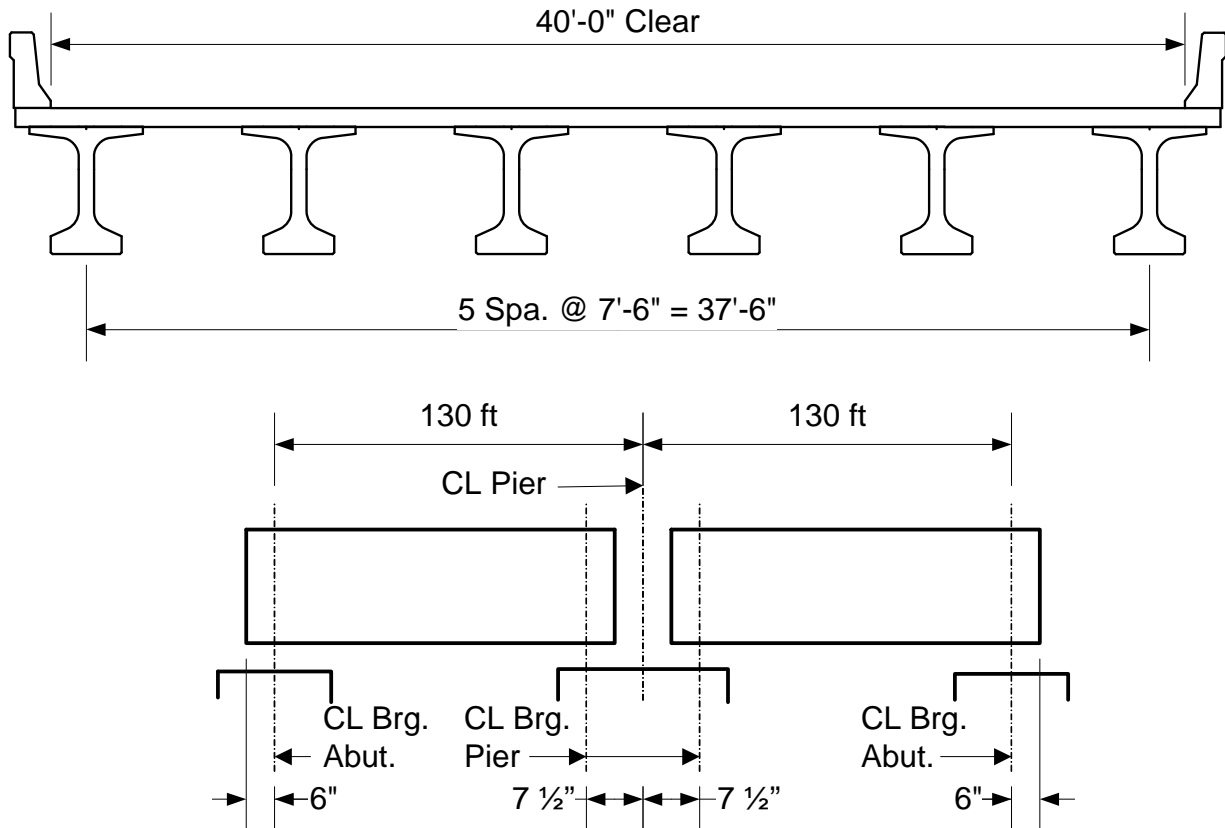

E45-3.1 Design Criteria

- L := 130** center of bearing at abutment to CL pier for each span, ft
- L_g := 130.375** total length of the girder (the girder extends 6 inches past the center of bearing at the abutment and 1.5" short of the center line of the pier).
- w_b := 42.5** out to out width of deck, ft
- w := 40** clear width of deck, 2 lane road, 3 design lanes, ft
- f'_c := 8** girder concrete strength, ksi
- f'_{cd} := 4** deck concrete strength, ksi
- f_y := 60** yield strength of mild reinforcement, ksi



$E_s := 29000$	ksi, Modulus of Elasticity of the reinforcing steel
$w_p := 0.387$	weight of Wisconsin Type LF parapet, klf
$t_s := 8$	slab thickness, in
$t_{se} := 7.5$	effective slab thickness, in
$skew := 0$	skew angle, degrees
$w_c := 0.150$	kcf
$h := 2$	height of haunch, inches

E45-3.2 Modulus of Elasticity of Beam and Deck Material

Based on past experience, the modulus of elasticity for the precast and deck concrete are given in Chapter 19 as $E_{beam6} := 5500$ ksi and $E_{deck4} := 4125$ ksi for concrete strengths of 6 and 4 ksi respectively. The values of E for different concrete strengths are calculated as follows (ksi):

$$E_{beam8} := 5500 \cdot \frac{\sqrt{f'_c \cdot 1000}}{\sqrt{6000}} \quad \boxed{E_{beam8} = 6351} \quad E_B := E_{beam8}$$

$$E_D := E_{deck4}$$

$$n := \frac{E_B}{E_D} \quad \boxed{n = 1.540}$$

E45-3.3 Section Properties

54W Girder Properties:

$w_{tf} := 48$	in
$t_w := 6.5$	in
$ht := 54$	in
$b_w := 30$	width of bottom flange, in
$A_g := 798$	in ²
$I_g := 321049$	in ⁴
$y_t := 27.70$	in
$y_b := -26.30$	in

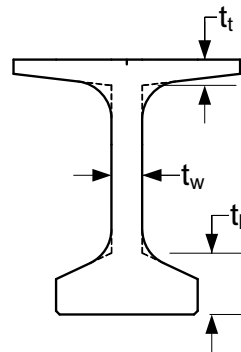



E45-3.4 Girder Layout

$S := 7.5$	Girder Spacing, feet
$s_{oh} := 2.50$	Deck overhang, feet
$ng := 6$	Number of girders

E45-3.5 Loads

$w_g := 0.831$	weight of 54W girders, klf
$w_d := 0.100$	weight of 8-inch deck slab (interior), ksf
$w_h := 0.100$	weight of 2-in haunch, klf
$w_{di} := 0.410$	weight of each diaphragm on interior girder (assume 2), kips
$w_{ws} := 0.020$	future wearing surface, ksf
$w_p = 0.387$	weight of parapet, klf

E45-3.5.1 Dead Loads

Dead load on non-composite (DC):

interior:

$$w_{dlii} := w_g + w_d \cdot S + w_h + 2 \cdot \frac{w_{di}}{L} \quad \boxed{w_{dlii} = 1.687} \text{ klf}$$

* Dead load on composite (DC):

$$w_p := \frac{2 \cdot w_p}{ng} \quad \boxed{w_p = 0.129} \text{ klf}$$

* Wearing Surface (DW):

$$w_{ws} := \frac{w \cdot w_{ws}}{ng} \quad \boxed{w_{ws} = 0.133} \text{ klf}$$

* **LRFD [5.4.6.2.2.1]** states that permanent loads on the deck may be distributed uniformly among the beams. This method is used for the parapet and future wearing surface loads.



E45-3.5.2 Live Loads

For Strength 1 and Service 1:

HL-93 loading = truck + lane LRFD [3.6.1.3.1]
truck pair + lane

DLA of 33% applied to truck or tandem, but not to lane per LRFD [3.6.2.1].

For Fatigue:

HL-93 truck (no lane) with 15% DLA and 30 ft rear axle spacing per LRFD [3.6.1.4.1].

E45-3.6 Load Distribution to Girders

In accordance with LRFD [Table 4.6.2.2.1-1], this structure is a Type "K" bridge.

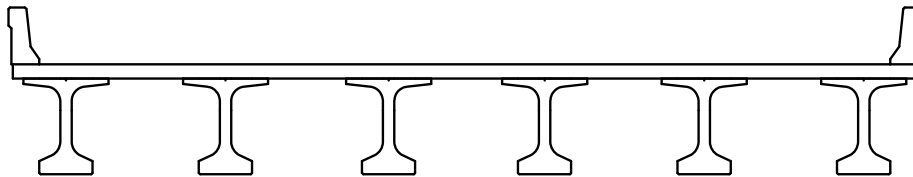

Distribution factors are in accordance with LRFD [Table 4.6.2.2.2b-1]. For an interior beam, the distribution factors are shown below:

For one Design Lane Loaded:

$$0.06 + \left(\frac{S}{14}\right)^{0.4} \cdot \left(\frac{S}{L}\right)^{0.3} \cdot \left(\frac{K_g}{12.0 \cdot L \cdot t_{se}^3}\right)^{0.1}$$

For Two or More Design Lanes Loaded:

$$0.075 + \left(\frac{S}{9.5}\right)^{0.6} \cdot \left(\frac{S}{L}\right)^{0.2} \cdot \left(\frac{K_g}{12.0 \cdot L \cdot t_{se}^3}\right)^{0.1}$$

$$e_g := y_t + h + \frac{t_{se}}{2} \quad \boxed{e_g = 33.45} \quad \text{in}$$

LRFD [Eq 4.6.2.2.1-1]

$$K_g := n \cdot (I_g + A_g \cdot e_g^2) \quad \boxed{K_g = 1868972} \quad \text{in}^4$$



Criteria for using distribution factors - Range of Applicability per LRFD [Table 4.6.2.2b-1].

$$\text{DeckSpan} := \begin{cases} \text{"OK"} & \text{if } 3.5 \leq S \leq 16 \\ \text{"NG"} & \text{otherwise} \end{cases}$$

$$\text{DeckThickness} := \begin{cases} \text{"OK"} & \text{if } 4.5 \leq t_s \leq 12 \\ \text{"NG"} & \text{otherwise} \end{cases}$$

$$\text{BridgeSpan} := \begin{cases} \text{"OK"} & \text{if } 20 \leq L \leq 240 \\ \text{"NG"} & \text{otherwise} \end{cases}$$

$$\text{NoBeams} := \begin{cases} \text{"OK"} & \text{if } ng \geq 4 \\ \text{"NG"} & \text{otherwise} \end{cases}$$

$$\text{LongitStiffness} := \begin{cases} \text{"OK"} & \text{if } 10000 \leq K_g \leq 7000000 \\ \text{"NG"} & \text{otherwise} \end{cases}$$

$$x := \begin{pmatrix} S & \text{DeckSpan} \\ t_s & \text{DeckThickness} \\ L & \text{BridgeSpan} \\ ng & \text{NoBeams} \\ K_g & \text{LongitStiffness} \end{pmatrix}$$

$$x = \begin{pmatrix} 7.5 & \text{"OK"} \\ 8.0 & \text{"OK"} \\ 130.0 & \text{"OK"} \\ 6.0 & \text{"OK"} \\ 1868972.4 & \text{"OK"} \end{pmatrix}$$

E45-3.6.1 Distribution Factors for Interior Beams:

One Lane Loaded:

$$g_{i1} := 0.06 + \left(\frac{S}{14}\right)^{0.4} \cdot \left(\frac{S}{L}\right)^{0.3} \cdot \left(\frac{K_g}{12.0 \cdot L \cdot t_{se}^3}\right)^{0.1}$$

$g_{i1} = 0.427$

Two or More Lanes Loaded:

$$g_{i2} := 0.075 + \left(\frac{S}{9.5}\right)^{0.6} \cdot \left(\frac{S}{L}\right)^{0.2} \cdot \left(\frac{K_g}{12.0 \cdot L \cdot t_{se}^3}\right)^{0.1}$$

$g_{i2} = 0.619$

$$g_i := \max(g_{i1}, g_{i2})$$

$g_i = 0.619$

Note: The distribution factors above already have a multiple lane factor included. For the Wis-SPV Design Check, the distribution factor for One Lane Loaded should be used and the 1.2 multiple presence factor should be divided out.



E45-3.8 Dead Load Moments

The unfactored dead load moments are listed below (values are in kip-ft):

Unfactored Dead Load Interior Girder Moments, (ft-kips)			
Tenth Point	DC non-composite	DC composite	DW composite
0.5	3548	137	141
0.6	3402	99	102
0.7	2970	39	40
0.8	2254	-43	-45
0.9	1253	-147	-151
1.0	0	-272	-281

The DC_{nc} values are the component non-composite dead loads and include the weight of the girder, haunch, diaphragms and the deck.

The DC_c values are the component composite dead loads and include the weight of the parapets.

The DW_c values are the composite dead loads from the future wearing surface.

Note that the girder dead load moments (a portion of DC_{nc}) are calculated based on the CL bearing to CL bearing length. The other DC_{nc} moments are calculated based on the span length (center of bearing at the abutment to centerline of the pier).

E45-3.9 Live Load Moments



The unfactored live load load moments (per lane including impact) are listed below (values are in kip-ft). Note that the impact factor is applied only to the truck portion of the HL-93 loads. A separate analysis run will be required if results without impact are desired.

Unfactored Live Load + Impact Moments per Lane (kip-ft)		
Tenth Point	Truck Pair	Truck + Lane
0.5	--	-921
0.6	--	-1106
0.7	--	-1290
0.8	-1524	-1474
0.9	-2046	-1845
1	-3318	-2517

The unfactored live load moments per lane are calculated by applying the appropriate distribution factor to the controlling moment. For the interior girder:

g_i = 0.619

M_{LL} = g_i · (-3317.97)

M_{LL} = -2055 kip-ft

E45-3.10 Composite Girder Section Properties

Calculate the effective flange width in accordance with Chapter 17.2.11.

The effective flange width is calculated as the minimum of the following two values:

$$w_e := S \cdot 12 \qquad w_e = 90.00 \text{ in}$$

The effective width, w_e, must be adjusted by the modular ratio, n = 1.54, to convert to the same concrete material (modulus) as the girder.

$$w_{eadj} := \frac{w_e}{n} \qquad w_{eadj} = 58.46 \text{ in}$$



Calculate the composite girder section properties:

effective slab thickness; $t_{se} = 7.50$ in

effective slab width; $W_{eadj} = 58.46$ in

haunch thickness; $h = 2.0$ in

total height; $h_c := h_t + h + t_{se}$

$h_c = 63.50$ in

$n = 1.540$

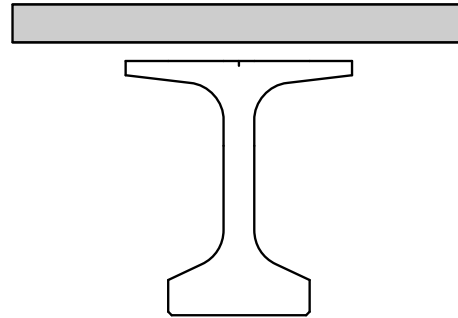

Note: The area of the concrete haunch is not included in the calculation of the composite section properties.

Component	Ycg	A	AY	AY ²	I	I+AY ²
Deck	59.75	438	26197	1565294	2055	1567349
Girder	26.3	798	20987	551969	321049	873018
Haunch	55	0	0	0	0	0
Summation		1236	47185			2440367

$\Sigma A := 1236$ in²

$\Sigma AY := 47185$ in⁴

$\Sigma IplusAYSq := 2440367$ in⁴

$Y_{cgb} := \frac{-\Sigma AY}{\Sigma A}$ $Y_{cgb} = -38.2$ in

$Y_{cgt} := h_t + Y_{cgb}$ $Y_{cgt} = 15.8$ in

$A_{cg} := \Sigma A$ in²

$I_{cg} := \Sigma IplusAYSq - A_{cg} \cdot Y_{cgb}^2$ $I_{cg} = 639053$ in⁴

Deck:



$$S_c := n \cdot \frac{I_{cg}}{y_{cgt} + h + t_{se}} \quad \boxed{S_c = 38851} \quad \text{in}^4$$

E45-3.11 Flexural Strength Capacity at Pier

All of the continuity reinforcement is placed in the top mat. Therefore the effective depth of the section at the pier is:

$$\text{cover} := 2.5 \quad \text{in}$$

$$\text{bar}_{\text{trans}} := 5 \quad (\text{transverse bar size})$$

$$\text{Bar}_D(\text{bar}_{\text{trans}}) = 0.625 \quad \text{in} \quad (\text{transverse bar diameter})$$

$$\text{Bar}_{\text{No}} = 10$$

$$\text{Bar}_D(\text{Bar}_{\text{No}}) = 1.27 \quad \text{in} \quad (\text{Assumed bar size})$$

$$d_e := ht + h + t_s - \text{cover} - \text{Bar}_D(\text{bar}_{\text{trans}}) - \frac{\text{Bar}_D(\text{Bar}_{\text{No}})}{2} \quad \boxed{d_e = 60.24} \quad \text{in}$$

For flexure in non-prestressed concrete, $\phi_f := 0.9$.

The width of the bottom flange of the girder, $b_w = 30.00$ inches.

The continuity reinforcement is distributed over the effective flange width calculated earlier, $w_e = 90.00$ inches.

From E19-2, use a longitudinal bar spacing of #4 bars at $s_{\text{longit}} := 8.5$ inches. The continuity reinforcement is placed at 1/2 of this bar spacing, .

#10 bars at 4.25 inch spacing provides an $\boxed{A_{s\text{prov}} = 3.57}$ in²/ft, or the total area of steel provided:

$$A_s := A_{s\text{prov}} \cdot \frac{w_e}{12} \quad \boxed{A_s = 26.80} \quad \text{in}^2$$

Calculate the capacity of the section in flexure at the pier:

Check the depth of the compression block:

$$a := \frac{A_s \cdot f_y}{0.85 \cdot b_w \cdot f'_c} \quad \boxed{a = 7.883} \quad \text{in}$$



This is approximately equal to the thickness of the bottom flange height of 7.5 inches.

$$M_n := A_s \cdot f_y \cdot \left(d_e - \frac{a}{2} \right) \cdot \frac{1}{12} \quad \boxed{M_n = 7544} \text{ kip-ft}$$

$$M_r := \phi_f M_n \quad \boxed{M_r = 6790} \text{ kip-ft}$$

E45-3.12 Design Load Rating

This design example illustrates the rating checks required at the location of maximum negative moment. These checks are also required at the locations of continuity bar cut offs but are not shown here.

At the Strength I Limit State:

$$RF = \frac{(\phi_c)(\phi_s)(\phi) R_n - \gamma_{DC}(DC_1) - \gamma_{DW}(DW_1)}{\gamma_L(LL + IM)}$$

Load Factors taken from Table 45.3-1

$$\gamma_{L_inv} := 1.75 \quad \gamma_{DC} := 1.25 \quad \gamma_{servLL} := 0.8 \quad \phi_c := 1.0 \quad \phi_s := 1.0$$

$$\gamma_{L_op} := 1.35 \quad \gamma_{DW} := 1.50 \quad \phi := 0.9 \quad \text{for flexure}$$

For Flexure

$$\boxed{M_n = 7544} \text{ kip-ft} \quad \boxed{M_{DCC} = 272} \text{ kip-ft} \quad \boxed{M_{LL} = 2055} \text{ kip-ft}$$

Inventory Level

$$RF_{Mom_Inv} := \frac{(\phi_c)(\phi_s)(\phi)(M_n) - \gamma_{DC}(M_{DCC})}{\gamma_{L_inv}(M_{LL})} \quad \boxed{RF_{Mom_Inv} = 1.793}$$

Operating Level

$$RF_{Mom_Op} := \frac{(\phi_c)(\phi_s)(\phi)(M_n) - \gamma_{DC}(M_{DCC})}{\gamma_{L_op}(M_{LL})} \quad \boxed{RF_{Mom_Op} = 2.325}$$

E45-3.13 Permit Load Rating

Check the Wisconsin Standard Permit Vehicle per 45.6



For a symmetric 130' two span structure:

MSPV_{LL} := 2738 kip-ft per lane (includes Dynamic Load Allowance of 33%)

Per 45.6, for the Wisconsin Standard Permit Vehicle (Wis-SPV) Design Check use single lane distribution factor assuming a single trip permit vehicle with no escort vehicles and assuming full dynamic load allowance. Also, divide out the 1.2 multiple presence factor per LRFR [6.4.5.4.2.2] for the single lane distribution factor only.

Single Lane Distribution

g₁ := g_{i1} * 1 / 1.2 [g₁ = 0.356]

M_{SPVLLIM} := (MSPV_{LL} + M_{Lane}) * g₁ [M_{SPVLLIM} = 975] kip-ft

RF_{SPV_m1} := [(φ_c)(φ_s)(φ)(M_n) - 1.25 * (M_{DCc}) - 1.5 * (M_{DWc})] / 1.5 * (M_{SPVLLIM}) [RF_{SPV_m1} = 4.121]

W_{t1} := RF_{SPV_m1} * 190 [W_{t1} = 783] kips >> 190 kips, OK

The rating for the Wis-SPV vehicle is now checked without the Future Wearing Surface. This value is reported on the plans.

RF_{SPV_m_pln} := [(φ_c)(φ_s)(φ)(M_n) - 1.25 * (M_{DCc})] / 1.5 * (M_{SPVLLIM}) [RF_{SPV_m_pln} = 4.409]

W_{tpln} := RF_{SPV_m_pln} * 190 [W_{tpln} = 838] kips

Since this value is greater than 250 kips, 250 kips is reported on the plans and on the Bridge Load Rating Summary form for the single-lane Permit Load Rating.

Multi-Lane Distribution

g₂ := g_{i2} [g₂ = 0.619]

M_{SPVLLIM} := MSPV_{LL} * g₂ [M_{SPVLLIM} = 1696] kip-ft



$$RF_{SPV_m2} := \frac{[(\phi_c)(\phi_s)(\phi)(M_n)] - 1.25 \cdot (M_{DCC})}{1.5(M_{SPVLLIM})}$$

$RF_{SPV_m2} = 2.535$

$$Wt_2 := RF_{SPV_m2} \cdot 190$$

$Wt_2 = 482$	kips
--------------	------

Since this value is greater than 250 kips, 250 kips is reported on the Bridge Load Rating Summary form for the multi-lane Permit Load Rating.

E45-3.14 Summary of Rating Factors

Limit State		Interior Girder				
		Design Load Rating		Legal Load	Permit Load Rating (kips)	
Strength 1	Flexure	Inventory	Operating	Rating	Single Lane	Multi-Lane
		1.79	2.32	N/A	250	250



This page intentionally left blank.