

EAU
 PROJECT ID: 7620-00-73
 WITH: N/A
 COUNTY: ST. CROIX
 16

SEPTEMBER 2023

ORDER OF SHEETS

Section No. 1	Title
Section No. 2	Typical Sections and Details
Section No. 3	Estimate of Quantities
Section No. 3	Miscellaneous Quantities
Section No. 4	Right of Way Plat
Section No. 5	Plan and Profile
Section No. 6	Standard Detail Drawings
Section No. 7	Sign Plates
Section No. 8	Structure Plans
Section No. 8	Computer Earthwork Data
Section No. 8	Grass Sections

TOTAL SHEETS = 36



DESIGN DESIGNATION 7620-00-73

A.A.D.T.	2024	=	3,200
A.A.D.T.	2044	=	N/A
D.H.V.		=	60/40
D.D.		=	N/A
T.		=	22.6%
DESIGN SPEED		=	55 MPH
ESALS		=	N/A

CONVENTIONAL SYMBOLS

PLAN	PROFILE
CORPORATE LIMITS	GRADE LINE
PROPERTY LINE	ORIGINAL GROUND
LOT LINE	MARSH OR ROCK PROFILE (To be noted as such)
LIMITED HIGHWAY EASEMENT	SPECIAL DITCH
EXISTING RIGHT OF WAY	GRADE ELEVATION
PROPOSED OR NEW R/W LINE	CULVERT (Profile View)
SLOPE INTERCEPT	UTILITIES
REFERENCE LINE	ELECTRIC
EXISTING CULVERT	FIBER OPTIC
PROPOSED CULVERT (Box or Pipe)	GAS
COMBUSTIBLE FLUIDS	SANITARY SEWER
MARSH AREA	STORM SEWER
WOODED OR SHRUB AREA	TELEPHONE
	WATER
	UTILITY PEDESTAL
	POWER POLE
	TELEPHONE POLE

STATE OF WISCONSIN
 DEPARTMENT OF TRANSPORTATION
 PLAN OF PROPOSED IMPROVEMENT
 ELMWOOD - STH 64
 IH94 (KWIK TRIP) INTERSECTION
 STH 128
 ST. CROIX COUNTY

STATE PROJECT NUMBER
 7620-00-73

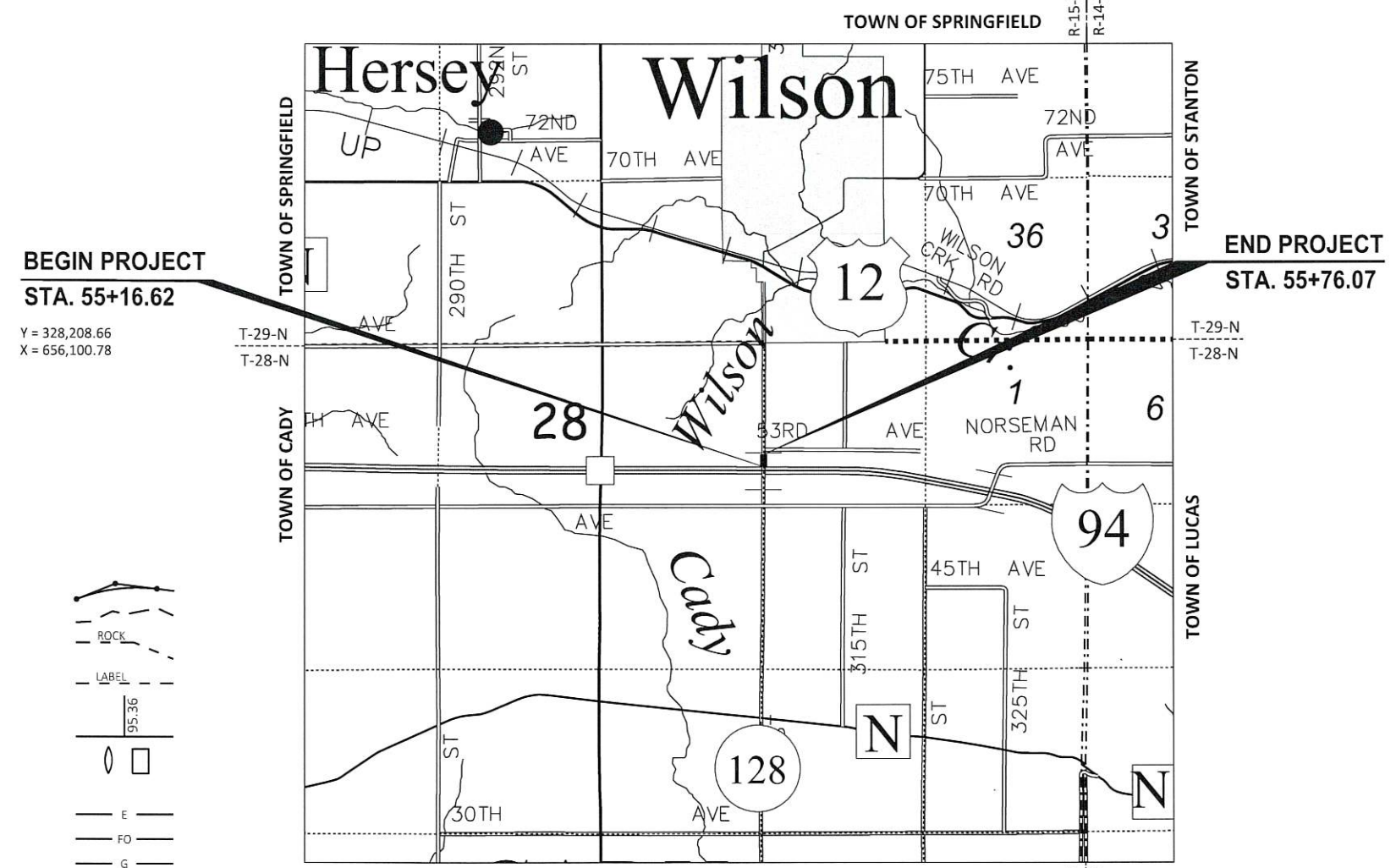

LAYOUT
 SCALE 0 1 MI
 TOTAL NET LENGTH OF CENTERLINE = 0.011 MILES

COORDINATES ON THIS PLAN ARE REFERENCED TO THE WISCONSIN COUNTY COORDINATE SYSTEM (WCCS), ST. CROIX COUNTY, NAD83 (2011), IN U.S. SURVEY FEET. VALUES ARE GRID COORDINATES, GRID BEARINGS, AND GRID DISTANCES. GRID DISTANCE MAY BE USED AS GROUND DISTANCES.

ELEVATION SHOWN ON THIS PLAN ARE REFERENCED TO THE NORTH AMERICAN VERTICAL DATUM OF 1988, NAVD88 (2012).

STATE PROJECT	FEDERAL PROJECT	
	PROJECT	CONTRACT
7620-00-73	WISC 2023625	1

ORIGINAL PLANS PREPARED BY
JEWELL
 associates engineers, inc.
 Engineers - Architects - Surveyors



DATE: 5/9/23
 (Professional Engineer Signature)

STATE OF WISCONSIN
 DEPARTMENT OF TRANSPORTATION

PREPARED BY

Surveyor	JEWELL ASSOCIATES ENGINEERS, INC.
Designer	JEWELL ASSOCIATES ENGINEERS, INC.
Project Manager	LANCE WILLISTON, P.E.
Regional Examiner	TOU YANG, P.E.
Regional Supervisor	JAMES KOENIG, P.E.

APPROVED FOR THE DEPARTMENT
 DATE: 5/10/2023 **JAMES KOENIG**
 (Signature)

E

GENERAL NOTES

NO TREES OR SHRUBS ARE TO BE REMOVED UNLESS SUCH TREES OR SHRUBS HAVE FIRST BEEN INDICATED FOR REMOVAL BY THE ENGINEER IN THE FIELD.

EROSION CONTROL ITEMS IN THE MISCELLANEOUS QUANTITIES ARE SUGGESTED. EXACT LOCATIONS WILL BE DETERMINED BY THE ENGINEER IN THE FIELD. MAINTAIN EROSION CONTROL ITEMS UNTIL SUCH TIME AS THE ENGINEER DETERMINES THE MEASURE IS NO LONGER NECESSARY. PROTECT WETLANDS AND OTHER WATERWAYS THAT ARE PRESENT WITHIN THE PROJECT LIMITS.

DISTURBED AREAS SHOWN WITHIN THE RIGHT-OF-WAY, EXCEPT THE AREAS WITHIN THE FINISHED SHOULDER POINTS ARE TO BE FERTILIZED (TYPE B), SEEDED (SEEDING MIXTURE NO. 20), AND MULCHED AS DIRECTED BY THE ENGINEER.

EXISTING SHOULDER AGGREGATE SHALL BE INCORPORATED INTO THE NEW SHOULDERS UNLESS OTHERWISE DIRECTED BY THE ENGINEER IN THE FIELD.

WHEN THE QUANTITY OF THE ITEM OF BASE AGGREGATE DENSE OR ASPHALTIC SURFACE IS MEASURED FOR PAYMENT BY THE TON, THE DEPTH OR THICKNESS OF THE COURSE SHOWN ON THE PLANS IS APPROXIMATE, AND THE ACTUAL THICKNESS WILL DEPEND ON THE DISTRIBUTION OF THE MATERIAL AS DIRECTED BY THE ENGINEER IN THE FIELD.

REMOVAL OF ASPHALTIC SURFACES WHERE AN ABUTTING ASPHALTIC SURFACE IS TO REMAIN IN PLACE SHALL REQUIRE A VERTICAL EDGE MEETING THE APPROVAL OF THE ENGINEER IN THE FIELD.

ASPHALTIC SURFACE QUANTITIES WERE CALCULATED USING 112 LB/SY/IN.

10-INCHES OF ASPHALTIC SURFACE SHALL BE CONSTRUCTED WITH 4-INCH AND 3.5-INCH LOWER LAYERS AND 2.5-INCH UPPER LAYER UNLESS OTHERWISE APPROVED BY THE ENGINEER IN THE FIELD.

THE LOCATIONS OF EXISTING AND PROPOSED UTILITY INSTALLATIONS AS SHOWN ON THE PLANS ARE APPROXIMATE. THERE MAY BE OTHER UTILITY INSTALLATIONS WITHIN THE PROJECT AREA THAT ARE NOT SHOWN. THE CONTRACTOR SHALL COORDINATE THEIR CONSTRUCTION ACTIVITIES WITH A CALL TO "DIGGERS HOTLINE" AND/OR A DIRECT CALL TO THE UTILITIES THAT HAVE FACILITIES IN THE AREA. NOT ALL UTILITIES ARE MEMBERS OF DIGGERS HOTLINE.

IF THERE ARE CONFLICTS WITH SIGNS OR OTHER WORK UNDER THIS PROJECT, THE CONTRACTOR WILL WORK AROUND THE UTILITY FACILITIES.

CONTACTS

WISCONSIN DEPARTMENT OF TRANSPORTATION:

WISDOT CONSULTANT PROJECT MANAGER
5400 KING JAMES WAY, SUITE 200
MADISON, WI 53717
ATTN: LANCE WILLISTON, P.E.
PH: (608) 663-1218
EMAIL: lwilliston@klengineering.com

WDNR LIAISON:

STATE OF WISCONSIN
DNR WEST CENTRAL REGION
1300 W CLAIREMONT AVE
EAU CLAIRE, WI 54701
ATTN: AMY LESIK
PH: (715) 495-1903
EMAIL: Amy.Lesik@wisconsin.gov

DESIGN CONSULTANT:

JEWELL ASSOCIATES ENGINEERS, INC.
560 SUNRISE DRIVE
SPRING GREEN, WI 53588
ATTN: JEFF SMITH, P.E.
PH: (608) 459-6091
EMAIL: Jeff.Smith@jewellassoc.com

UTILITIES

COMMUNICATION LINE

WEST WISCONSIN TELCOM
ATTN: BRADLEY SCHMIDTKNECHT
912 CRESCENT STREET
MENOMONIE, WI 54751
OFFICE: (715) 231-0504
CELL: (715) 308-1914
EMAIL: brads@wwt.coop

GAS/PETROLEUM

WE ENERGIES
ATTN: STEVEN CHAVERS
104 W. SOUTH STREET
RICE LAKE, WI 54868
OFFICE: (715) 234-9605
CELL: (715) 213-4327
EMAIL: We-Utility-relocations@we-energies.com

ELECTRIC

XCEL ENERGY
TRAVIS WERLEIN
320 HELLER ROAD
MENOMONIE, WI 54751
CELL: (715) 495-3441
EMAIL: travis.a.werlein@xcelenergy.com

LIST OF STANDARD ABBREVIATIONS

ABUT	Abutment	INV	Invert	RDWY	Roadway
AC	Acre	IP	Iron Pipe or Pin	SALV	Salvaged
AGG	Aggregate	IRS	Iron Rod Set	SAN S	Sanitary Sewer
AH	Ahead	JT	Joint	SEC	Section
<	Angle	JCT	Junction	SHLDR	Shoulder
ASPH	Asphaltic	LHF	Left-Hand Forward	SHR	Shrinkage
AVG	Average	L	Length of Curve	SW	Sidewalk
ADT	Average Daily Traffic	LIN FT	Linear Foot	S	South
BAD	Base Aggregate Dense	or LF		SQ	Square
BK	Back	LC	Long Chord of Curve	SF or SQ FT	Square Feet
BF	Back Face	MH	Manhole	SY or SQ YD	Square Yard
BM	Bench Mark	MB	Mailbox	STD	Standard
BR	Bridge	ML or M/L	Match Line	SDD	Standard Detail Drawings
C or C/L	Center Line	N	North	STH	State Trunk Highways
CC	Center to Center	Y	North Grid Coordinate	STA	Station
C.E.	Commercial Entrance	OD	Outside Diameter	SS	Storm Sewer
CTH	County Trunk Highway	PLE	Permanent Limited Easement	SG	Subgrade
CR	Creek	PT	Point	SE	Superelevation
CR	Crushed	PC	Point of Curvature	SL or S/L	Survey Line
CY or CU YD	Cubic Yard	PI	Point of Intersection	SV	Septic Vent
CP	Culvert Pipe	PRC	Point of Reverse Curvature	T	Tangent
C & G	Curb and Gutter			TEL	Telephone
D	Degree of Curve	PT	Point of Tangency	TEMP	Temporary
DHV	Design Hour Volume	POC	Point On Curve	TI	Temporary Interest
DIA	Diameter	POT	Point on Tangent	TLE	Temporary Limited Easement
E	East	PVC	Polyvinyl Chloride	t	Ton
X	East Grid Coordinate	PCC	Portland Cement Concrete	T or TN	Town
ELEC	Electric (al)	LB	Pound	TRANS	Transition
EL or ELEV	Elevation	PSI	Pounds Per Square Inch	TL or T/L	Transit Line
ESALS	Equivalent Single Axle Loads	P.E.	Private Entrance	T	Trucks (percent of)
EBS	Excavation Below Subgrade	R	Radius	TYP	Typical
FF	Face to Face	RR	Railroad	UNCL	Unclassified
F.E.	Field Entrance	R	Range	UG	Underground Cable
F	Fill	RL or R/L	Reference Line	USH	United States Highway
FG	Finished Grade	RP	Reference Point	VAR	Variable
FL or F/L	Flow Line	RCCP	Reinforced Concrete Culvert Pipe	V	Velocity or Design Speed
FT	Foot	REQD	Required	VERT	Vertical
FTG	Footing	RES	Residence or Residential	VC	Vertical Curve
GN	Grid North	RW	Retaining Wall	VOL	Volume
HT	Height	RT	Right	WM	Water Main
CWT	Hundredweight	RHF	Right-Hand Forward	WV	Water Valve
HYD	Hydrant	R/W	Right-of-Way	W	West
INL	Inlet	RD	Road	WB	Westbound
ID	Inside Diameter	R	River	YD	Yard

ORDER OF SECTION 2 SHEETS:

- WRITTEN MATERIAL
- PROJECT OVERVIEW
- TYPICAL SECTIONS
- CONSTRUCTION DETAILS
- EROSION CONTROL
- PERMANENT SIGNING
- TRAFFIC CONTROL

	HYDROLOGIC SOIL GROUP											
	A			B			C			D		
	SLOPE RANGE (PERCENT)			SLOPE RANGE (PERCENT)			SLOPE RANGE (PERCENT)			SLOPE RANGE (PERCENT)		
LAND USE	0-2	2-6	6 & OVER	0-2	2-6	6 & OVER	0-2	2-6	6 & OVER	0-2	2-6	6 & OVER
ROW CROPS	.08 .22	.16 .30	.22 .38	.12 .26	.20 .34	.27 .44	.15 .30	.24 .37	.33 .50	.19 .34	.28 .41	.38 .56
MEDIAN STRIP TURF	.19 .24	.20 .26	.24 .30	.19 .25	.22 .28	.26 .33	.20 .26	.23 .30	.30 .37	.20 .27	.25 .32	.30 .40
SIDE SLOPE TURF			.25 .32			.27 .34			.28 .36			.30 .38
PAVEMENT												
ASPHALT	.70 - .95											
CONCRETE	.80 - .95											
BRICK	.70 - .80											
DRIVES, WALKS	.75 - .85											
ROOFS	.75 - .95											
GRAVEL ROADS, SHOULDERS	.40 - .60											

TOTAL PROJECT AREA= 0.07 ACRES
TOTAL AREA EXPECTED TO BE DISTURBED BY CONSTRUCTION ACTIVITIES = 0.07 ACRES



PROJECT NO: 7620-00-73	HWY: STH 128	COUNTY: ST. CROIX	PROJECT OVERVIEW	SHEET	E
------------------------	--------------	-------------------	------------------	-------	---

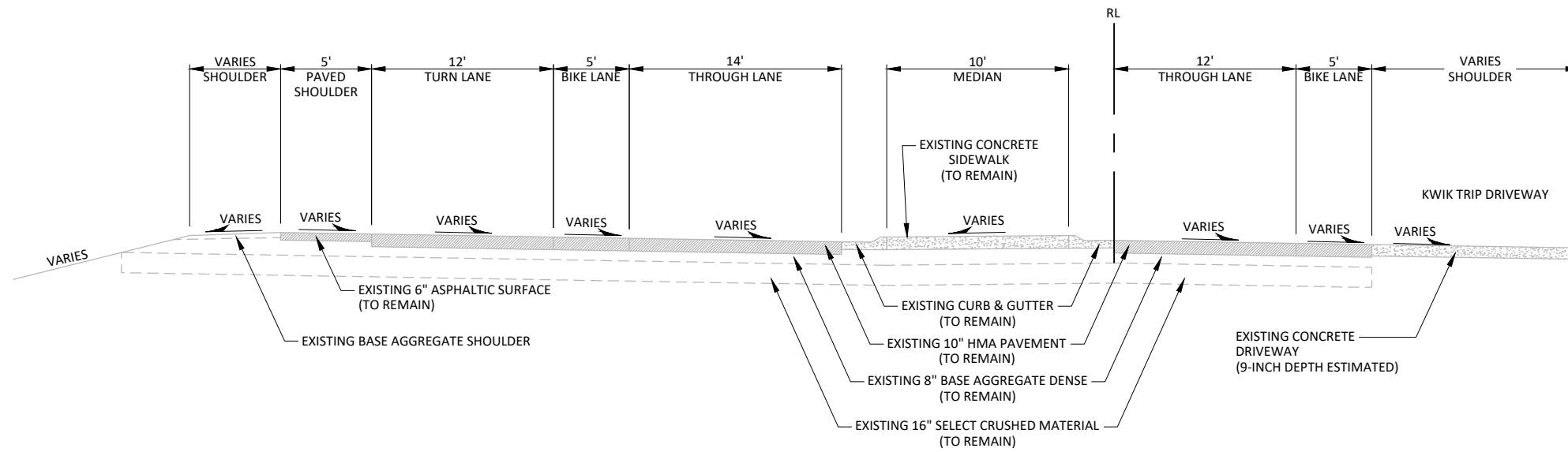

TYPICAL EXISTING SECTION

STH 128 (LOOKING NORTH)
STA. 55+16.62 - STA. 55+76.07

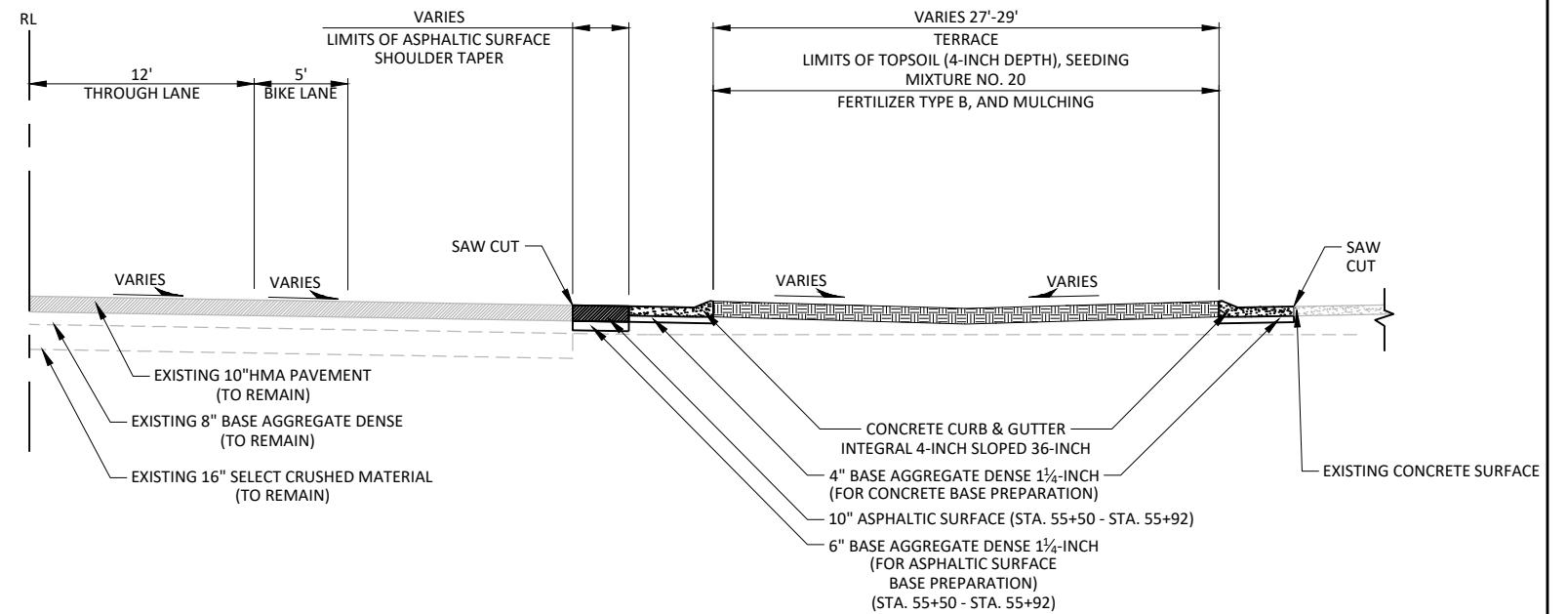

TYPICAL FINISHED SECTION

STH 128 (LOOKING NORTH)
STA. 55+16.62 - 55+76.07

LEGEND

- CONCRETE CURB & GUTTER INTEGRAL 4-INCH SLOPED 36-INCH
- CONCRETE CURB & GUTTER 4-INCH SLOPED 36-INCH TYPE A
- CONCRETE DRIVEWAY HES 9-INCH
- TOPSOIL, SEEDING MIXTURE NO. 20, FERTILIZER TYPE B, AND MULCHING
- SAWING ASPHALT
- SAWING CONCRETE
- WETLANDS

END PROJECT
7620-00-73
STA. 55+76.07

BEGIN PROJECT
7620-00-73
STA. 55+16.62
Y: 328,208.65
X: 656,100.78

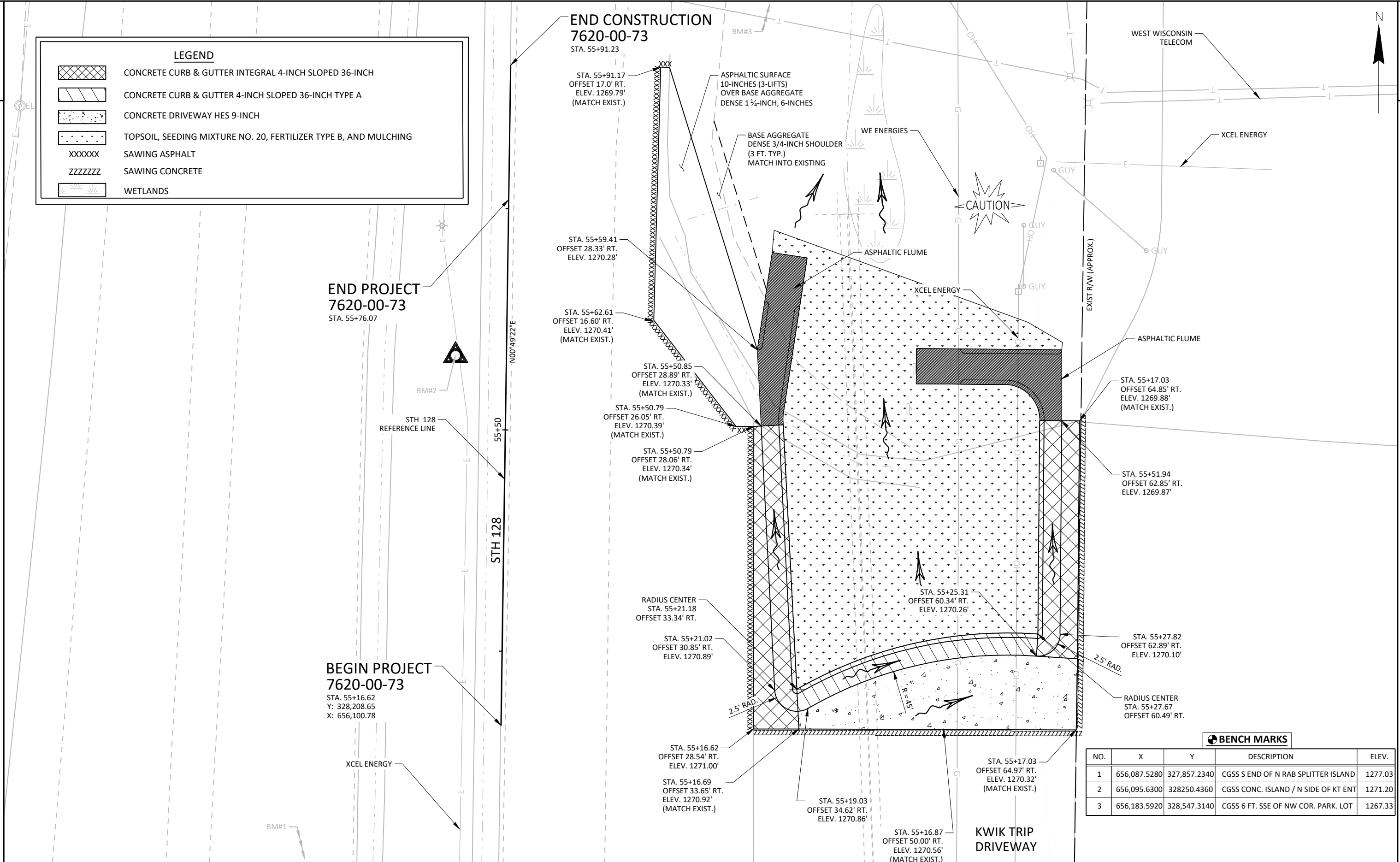

END CONSTRUCTION
7620-00-73
STA. 55+91.23



BENCH MARKS				
NO.	X	Y	DESCRIPTION	ELEV.
1	656,087.5280	327,857.2340	CGSS S END OF N RAB SPLITTER ISLAND	1277.03
2	656,095.6300	328250.4360	CGSS CONC. ISLAND / N SIDE OF KT ENT	1271.20
3	656,183.5920	328,547.3140	CGSS 6 FT. SSE OF NW COR. PARK. LOT	1267.33



LEGEND

-  SIGN TYPE II REFLECTIVE H ON POSTS WOOD 4x6-INCH
-  EXISTING SIGNS TYPE II

(SEE MISCELLANEOUS QUANTITY SHEET FOR ADDITIONAL INFORMATION)

REMOVE EXISTING TYPE II SIGNS (2) AND SMALL SIGN SUPPORTS (1)
"RIGHT ONLY & NO TRUCKS"

REMOVE EXISTING TYPE II SIGN AND SMALL SIGN SUPPORT
"NO ACCESS TO 94"

 06
REMOVE

55+50

01

J22-1
24"x57"

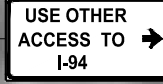
02

J22-1
24"x57"

03

R10-70R
72"x36"

04

R5-1
30"x30"



05

R5-1A
36"x24"

07

R5-1
30"x30"

SIGN

LEGEND

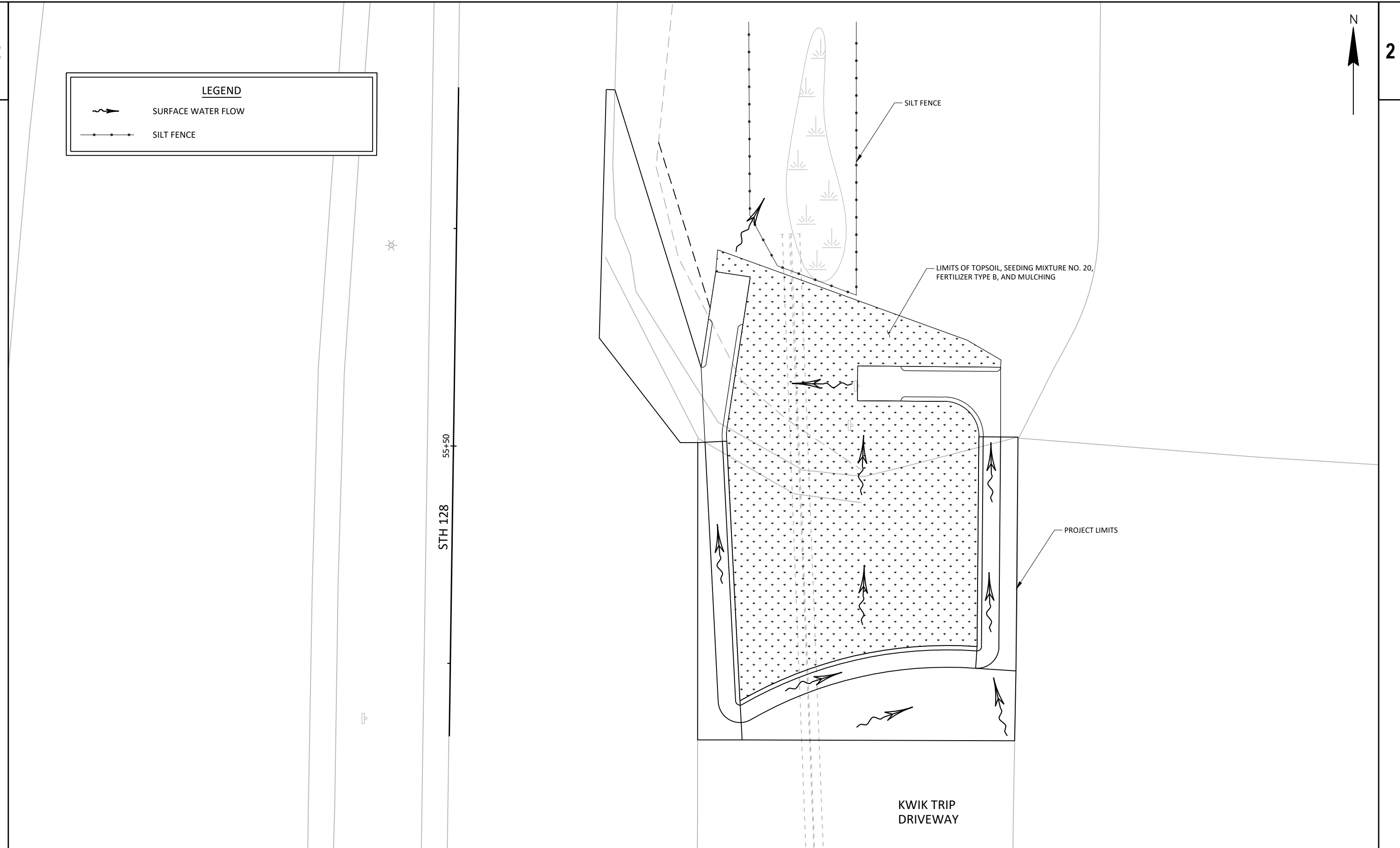
 SURFACE WATER FLOW
 SILT FENCE



GENERAL NOTES

DETAILS OF TRAFFIC CONTROL DEVICES AND INSTALLATION NOT SHOWN ON THIS DRAWING SHALL CONFORM TO THE PERTINENT REQUIREMENTS OF THE STANDARD SPECIFICATIONS. THE SPECIAL PROVISIONS, AND THE MANUAL ON UNIFORM TRAFFIC CONTROL DEVICES.

ALL SIGNS ARE 48" X 48" UNLESS OTHERWISE NOTED.

"WO" SIGNS ARE THE SAME AS "W" SIGNS EXCEPT THE BACKGROUND IS ORANGE

THE EXACT NUMBER, LOCATION, AND SPACING OF ALL SIGNS AND DEVICES SHALL BE ADJUSTED TO FIT FIELD CONDITIONS AS APPROVED BY THE ENGINEER.

THE FIRST ADVANCE WARNING SIGN SHOULD TYPICALLY BE LOCATED IN ADVANCE OF THE ANTICIPATED TRAFFIC BACKUP OR QUEUE.

THE SPACING BETWEEN TRAFFIC CONTROL SIGNS SHOULD BE ADJUSTED TO PROVIDE A MINIMUM OF 200 FEET (500 FEET DESIRABLE) DISTANCE TO, EXISTING SIGNS THAT WILL REMAIN IN PLACE.

CHANNELIZING DEVICES PLACED ADJACENT TO WORK AREA SHALL BE PULLED BACK FROM THE TRAVEL LANE WHEN WORK IS NOT IN PROGRESS.





WARNING LIGHTS ARE NOT REQUIRED IF THE LANE CLOSURE IS A DAYTIME ONLY OPERATION.

SDD

SEE SDD "TRAFFIC CONTROL FOR ADDED LANE CLOSURE WITHOUT LANE SHIFT" FOR DETAILS NOT SHOWN.

SEE SDD "TRAFFIC CONTROL, SHOULDER CLOSURE ON DIVIDED ROADWAY, SPEEDS GREATER THAN 40 MPH" FOR DETAILS NOT SHOWN.

LEGEND

-  SIGN ON PORTABLE OR PERMANENT SUPPORT
-  DIRECTION OF TRAFFIC
-  WORK AREA
-  TYPE III BARRICADE WITH/ WITHOUT ATTACHED SIGN
-  TRAFFIC CONTROL DRUM

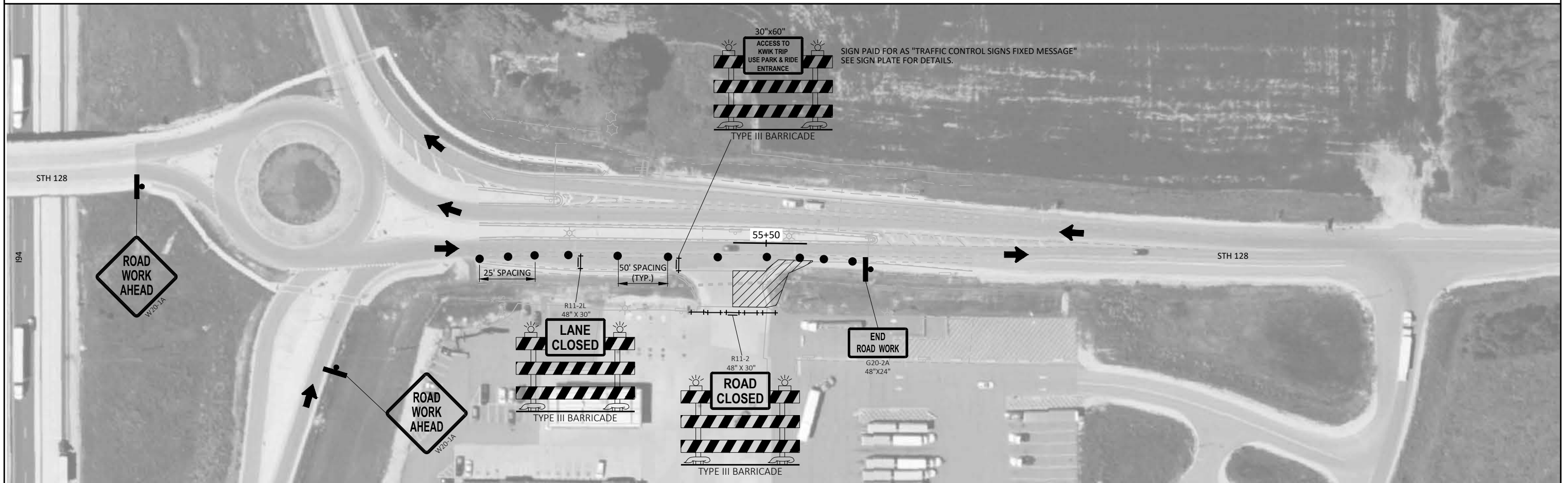

Estimate Of Quantities

7620-00-73

Line	Item	Item Description	Unit	Total	Qty
0002	204.0100	Removing Concrete Pavement	SY	130.000	130.000
0004	204.0110	Removing Asphaltic Surface	SY	8.000	8.000
0006	204.0150	Removing Curb & Gutter	LF	45.000	45.000
0008	205.0100	Excavation Common	CY	15.000	15.000
0010	208.0100	Borrow	CY	5.000	5.000
0012	213.0100	Finishing Roadway (project) 01. 7620-00-73	EACH	1.000	1.000
0014	305.0110	Base Aggregate Dense 3/4-Inch	TON	5.000	5.000
0016	305.0120	Base Aggregate Dense 1 1/4-Inch	TON	29.000	29.000
0018	416.0290	Concrete Driveway HES 9-Inch	SY	25.000	25.000
0020	465.0105	Asphaltic Surface	TON	16.000	16.000
0022	465.0315	Asphaltic Flumes	SY	17.000	17.000
0024	601.0501	Concrete Curb & Gutter Integral 4-Inch Sloped 36-Inch	LF	56.000	56.000
0026	601.0551	Concrete Curb & Gutter 4-Inch Sloped 36-Inch Type A	LF	29.000	29.000
0028	619.1000	Mobilization	EACH	1.000	1.000
0030	624.0100	Water	MGAL	1.000	1.000
0032	625.0100	Topsoil	SY	125.000	125.000
0034	627.0200	Mulching	SY	125.000	125.000
0036	628.1504	Silt Fence	LF	70.000	70.000
0038	628.1520	Silt Fence Maintenance	LF	70.000	70.000
0040	628.1905	Mobilizations Erosion Control	EACH	2.000	2.000
0042	628.1910	Mobilizations Emergency Erosion Control	EACH	1.000	1.000
0044	629.0210	Fertilizer Type B	CWT	0.080	0.080
0046	630.0120	Seeding Mixture No. 20	LB	4.000	4.000
0048	630.0200	Seeding Temporary	LB	4.000	4.000
0050	634.0616	Posts Wood 4x6-Inch X 16-FT	EACH	6.000	6.000
0052	637.2210	Signs Type II Reflective H	SF	55.500	55.500
0054	638.2602	Removing Signs Type II	EACH	4.000	4.000
0056	638.3000	Removing Small Sign Supports	EACH	2.000	2.000
0058	643.0300	Traffic Control Drums	DAY	154.000	154.000
0060	643.0420	Traffic Control Barricades Type III	DAY	98.000	98.000
0062	643.0705	Traffic Control Warning Lights Type A	DAY	84.000	84.000
0064	643.0900	Traffic Control Signs	DAY	70.000	70.000
0066	643.1000	Traffic Control Signs Fixed Message	SF	12.500	12.500
0068	643.5000	Traffic Control	EACH	1.000	1.000
0070	650.5500	Construction Staking Curb Gutter and Curb & Gutter	LF	85.000	85.000
0072	650.8000	Construction Staking Resurfacing Reference	LF	60.000	60.000
0074	650.9911	Construction Staking Supplemental Control (project) 01. 7620-00-73	EACH	1.000	1.000
0076	690.0150	Sawing Asphalt	LF	81.000	81.000
0078	690.0250	Sawing Concrete	LF	72.000	72.000
0080	ASP.1T0A	On-the-Job Training Apprentice at \$5.00/HR	HRS	80.000	80.000
0082	ASP.1T0G	On-the-Job Training Graduate at \$5.00/HR	HRS	80.000	80.000

REMOVING CONCRETE PAVEMENT	
STATION - STATION	204.0100 (SY)
55+16 - 55+26	130
TOTAL =	130

REMOVING ASPHALTIC SURFACE	
STATION - STATION	204.0110 (SY)
55+16 - 55+26	8
TOTAL =	8

REMOVING CURB & GUTTER		
STATION - STATION	LOCATION	204.0150 (LF)
55+45 - 55+72	MAINLINE, RT.	45
TOTAL =		45

BASE AGGREGATE DENSE				
STATION - STATION	LOCATION	305.0110 BASE AGGREGATE DENSE 3/4 - INCH (TON)	305.0120 BASE AGGREGATE DENSE 1 1/4 - INCH (TON)	624.0100 WATER (MGAL)
55+16 - 55+91	MAINLINE, RT	5	29	1.00
TOTALS =		5	29	1.00

3

3

CONCRETE DRIVEWAY 9-INCH HES		
STATION - STATION	LOCATION	416.0290 CONCRETE DRIVEWAY 9-INCH HES (SY)
55+16 - 55+26	MAINLINE, RT	25
TOTAL =		25

ASPHALTIC SURFACE		
STATION - STATION	LOCATION	465.0105 ASPHALTIC SURFACE (TON)
55+50 - 55+91	MAINLINE, RT	16
TOTAL =		16

ASPHALTIC FLUMES		
STATION - STATION	LOCATION	465.0315 ASPHALTIC FLUMES (SY)
55+51 - 55+70	MAINLINE, RT	17
TOTALS =		17

CONCRETE CURB & GUTTER			
STATION - STATION	LOCATION	601.0501 INTEGRAL 4-INCH SLOPED 36-INCH (LF)	601.0551 4-INCH SLOPED 36-INCH TYPE A (LF)
55+20 - 55+51	MAINLINE, RT.	31	-
55+27 - 55+52	MAINLINE, RT.	25	-
55+18 - 55+29	MAINLINE, RT.	-	29
TOTALS =		56	29

EXCAVATION			
STATION - STATION	LOCATION	205.0100 COMMON EXCAVATION (CY)	208.0100 BORROW (CY)
55+16 - 55+52	UNDISTRIBUTED	15	5
TOTALS =		15	5

FINISHING ITEMS						
STATION - STATION	LOCATION	625.0100 TOPSOIL (SY)	627.0200 MULCHING (SY)	629.0210 FERTILIZER TYPE B (CWT)	630.0120 SEEDING MIXTURE NO. 20 (LB)	630.0200 SEEDING TEMPORARY (LB)
55+22 - 55+73	MAINLINE, RT	125	125	0.08	4	4
TOTALS =		125	125	0.08	4	4

SILT FENCE			
STATION - STATION	LOCATION	628.1504 SILT FENCE (LF)	628.1520 SILT FENCE MAINTENANCE (LF)
55+68 - 56+00	628	70	70
TOTALS =		70	70

MOBILIZATIONS EROSION CONTROL		
PROJECT	628.1905 MOBILIZATIONS EROSION CONTROL (EACH)	628.1910 MOBILIZATIONS EMERGENCY EROSION CONTROL (EACH)
7620-00-73	2	1
TOTALS =	2	1

PERMANENT SIGNING									
NUMBER	APPROX. STATION	LOCATION	SIGN CODE	SIGN DESCRIPTION	634.0616 POSTS WOOD 4x6-INCH x 16-FT (EACH)	638.2602 REMOVING SIGNS TYPE II (EACH)	638.3000 REMOVING SMALL SIGN SUPPORTS (EACH)	637.2210 SIGNS TYPE II REFLECTIVE H (SF)	TOTALS
07	54+65	MAINLINE, RT	R5-1	DO NOT ENTER	1	-	-	6.25	
06	55+18	MAINLINE, LT	R6-2-R	ONE WAY (RIGHT)	-	1	-	-	
05	55+29	MAINLINE, RT	R5-1A	WRONG WAY	1	-	-	6	
04	55+33	MAINLINE, RT	R5-1	DO NOT ENTER	1	-	-	6.25	
03	55+51	MAINLINE, RT	R10-70R	USE OTHER ACCESS TO I-94	1	-	-	18	
01	58+70	MAINLINE, RT	J22-1	TO INTERSTATE 94 (AHEAD)	1	-	-	9.5	
02	58+70	MAINLINE, RT	J22-1	TO INTERSTATE 94 (AHEAD)	1	-	-	9.5	
08	55+75	KWIK TRIP		NO ACCESS TO 94	-	1	1	-	
09	55+80	KWIK TRIP		RIGHT TURN ONLY	-	1	1	-	
10	55+80	KWIK TRIP		NO TRUCKS	-	1	-	-	
TOTALS =					6	4	2	55.5	

TRAFFIC CONTROL						
LOCATION	643.0300 DRUMS (DAYS)	643.0420 BARRICADES TYPE III (DAY)	643.0705 WARNING LIGHTS TYPE A (DAY)	643.0900 SIGNS (DAYS)	643.1000 TRAFFIC CONTROL SIGNS FIXED MESSAGE (SF)	643.5000 TRAFFIC CONTROL (EACH)
PROJECT	154	98	84	70	12.5	1
TOTALS =	154	98	84	70	12.5	1

CONSTRUCTION STAKING		
LOCATION	650.9911 SUPPLEMENTAL CONTROL 7620-00-73 (LS)	650.5500 CURB & GUTTER (LF)
PROJECT	1	85
TOTALS =	1	85

SAWING			
STATION	LOCATION	690.0150 ASPHALT (LF)	690.0250 CONCRETE (LF)
55+16 - 55+91	MAINLINE, RT	81	-
55+16 - 55+52	MAINLINE, RT	-	72
TOTAL =		81	72

Standard Detail Drawing List

08D01-22A	CONCRETE CURB & GUTTER
08D01-22B	CONCRETE CURB, TIES AND CURB AND GUTTER APPLICATIONS
08D04-06	CONCRETE SURFACE DRAINS & ASPHALTIC FLUMES
08E09-06	SILT FENCE
15D27-03	TRAFFIC CONTROL, SHOULDER CLOSURE ON DIVIDED ROADWAY, SPEEDS GREATER THAN 40 MPH
15D50-02A	TRAFFIC CONTROL, ADDED LANE CLOSURE WITHOUT LANE SHIFT

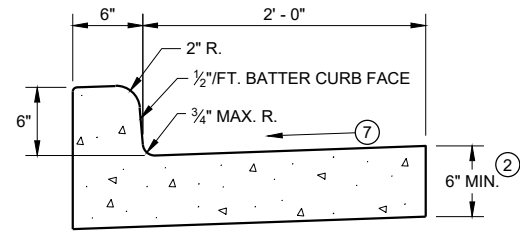

TYPES A^① & D

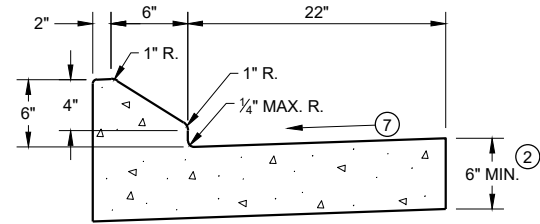

6" SLOPED CURB TYPES G^① & J

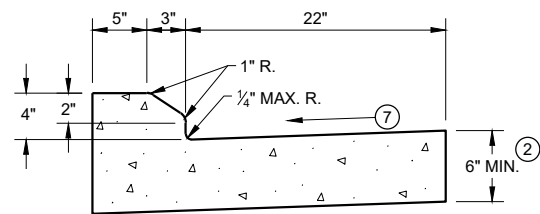

4" SLOPED CURB TYPES G^① & J

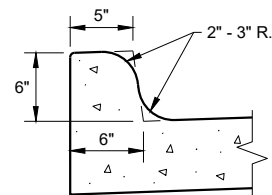

TYPES K^① & L
(OPTIONAL CURB SHAPE)

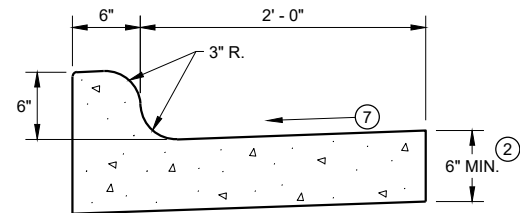

TYPES K^① & L

CONCRETE CURB AND GUTTER 30"

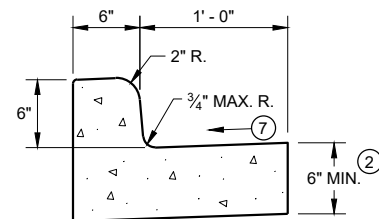

TYPES A^① & D

CONCRETE CURB AND GUTTER 18"

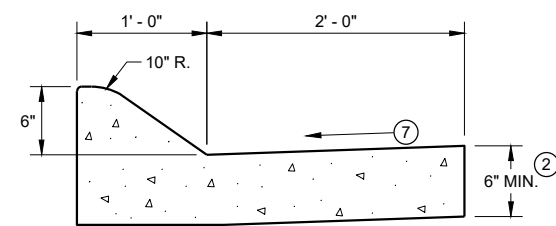

6" SLOPED CURB TYPES A^① & D

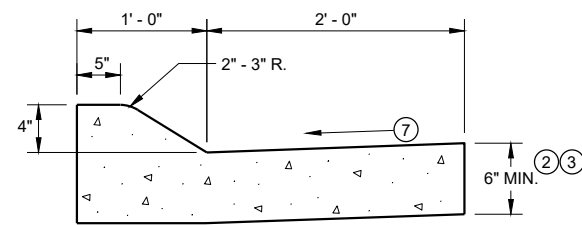

4" SLOPED CURB TYPES A^① & D

CONCRETE CURB AND GUTTER 36"

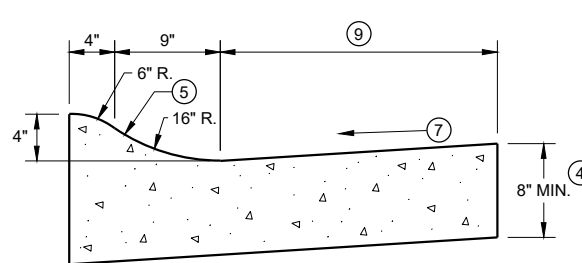

4" SLOPED CURB TYPES R^① & T

TBT & TBTT	X
30"	22"
36"	28"

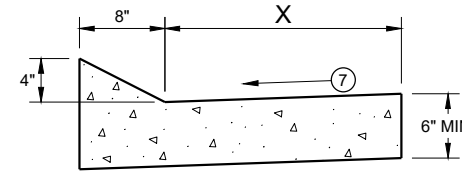

TYPES TBT & TBTT^①

CONCRETE CURB AND GUTTER

PAVEMENT THICKNESS AND MAXIMUM CONCRETE PANEL WIDTH TABLE

PAVEMENT THICKNESS	MAXIMUM PANEL WIDTH
LESS THAN 10"	12'
10" & ABOVE	15'

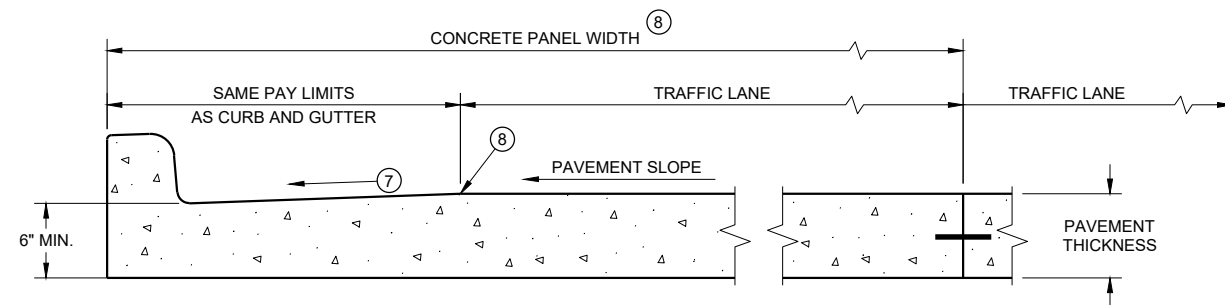

PARTIAL SECTION OF PAVEMENT *
WITH INTEGRAL CURB AND GUTTER

* BIKE LANE IS NOT SHOWN

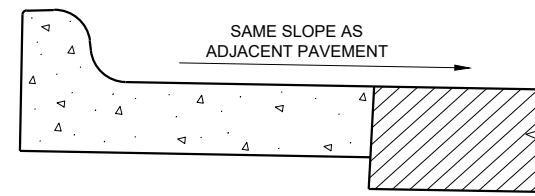

REVERSE SLOPE GUTTER^⑥
(TYPICAL FOR ALL CURB & GUTTER TYPES)

GENERAL NOTES

DETAILS OF CONSTRUCTION AND WORKMANSHIP NOT SHOWN ON THIS DRAWING SHALL CONFORM TO THE PERTINENT REQUIREMENTS OF THE CONTRACT.

PAVEMENT TIES AND TIE BARS SHALL BE EPOXY COATED IN CONFORMANCE WITH SUBSECTION 505.2.6.2 OF THE STANDARD SPECIFICATIONS.

INTEGRAL CURB AND GUTTER SHALL CONFORM TO THE DETAILS SHOWN FOR CONCRETE CURB AND GUTTER INCLUDING THE TRANSVERSE GUTTER SLOPE.

UNLESS OTHERWISE SHOWN ON THE TYPICAL CROSS SECTIONS, THE BASE AGGREGATE AND COMMON EXCAVATION LIMITS ARE 2' - 0" BEHIND THE BACK OF CURBS.

- ① TIE BARS ARE REQUIRED FOR CURB AND GUTTERS TYPES A, G, K, R, AND TBTT.
- ② THE BOTTOM OF CURB AND GUTTER MAY BE CONSTRUCTED EITHER LEVEL OR PARALLEL TO THE SLOPE OF THE SUBGRADE OR BASE AGGREGATE PROVIDED A 6" MINIMUM GUTTER THICKNESS IS MAINTAINED.
- ③ USE 8" MINIMUM GUTTER THICKNESS WHEN USED WITH AN ADJACENT CONCRETE TRUCK APRON PLACED BEHIND BACK OF CURB.
- ④ THE BOTTOM OF CURB AND GUTTER MAY BE CONSTRUCTED EITHER LEVEL OR PARALLEL TO THE SLOPE OF THE SUBGRADE OR BASE AGGREGATE PROVIDED A 8" MINIMUM GUTTER THICKNESS IS MAINTAINED.
- ⑤ UNLESS OTHERWISE NOTED, FOR STAKING PURPOSES THE FACE OF CURB IS 6" FROM THE BACK OF CURB.
- ⑥ WHEN REVERSE SLOPE GUTTER IS REQUIRED, THE LOCATION(S) WILL BE SHOWN ELSEWHERE IN THE PLAN.
- ⑦ USE 4% GUTTER CROSS SLOPE UNLESS OTHERWISE NOTED IN THE PLANS.
- ⑧ INCLUDE LONGITUDINAL JOINT AND TIE BARS ALONG LANE EDGE WHEN CONCRETE PANEL WIDTH EXCEEDS THE MAXIMUM WIDTH PER TABLE BELOW. LONGITUDINAL JOINT(S) ARE NOT ALLOWED WITHIN TRAFFIC LANES AND BIKE LANES. LONGITUDINAL JOINT MAY BE SAWED.
- ⑨ CONCRETE CURB AND GUTTER 4-INCH SLOPED 30-INCH TYPE "R" AND "T" = 17 INCHES
CONCRETE CURB AND GUTTER 4-INCH SLOPED 36-INCH TYPE "R" AND "T" = 23 INCHES

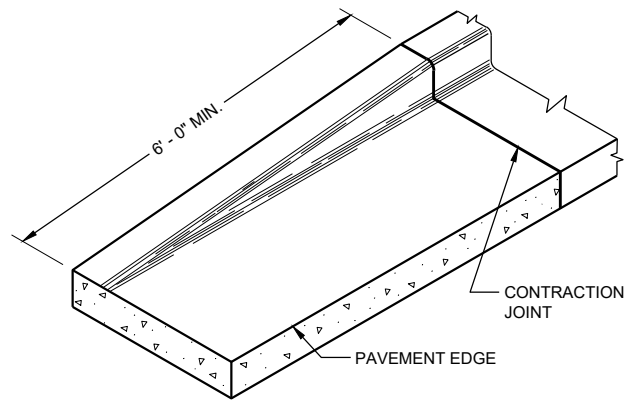

END SECTION CURB AND GUTTER

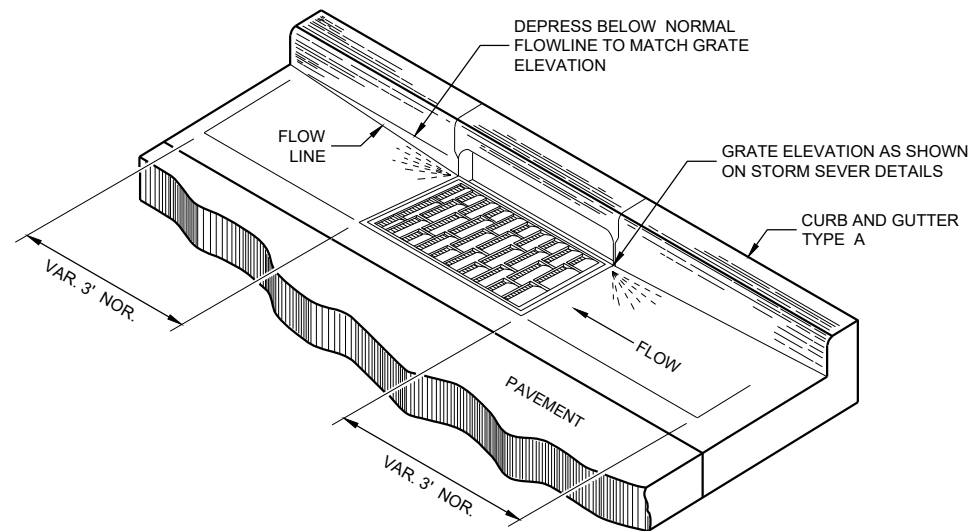

DETAIL OF CURB AND GUTTER AT INLETS
(TYPICAL H INLET COVER SHOWN)

GENERAL NOTES

DETAILS OF CONSTRUCTION AND WORKMANSHIP NOT SHOWN ON THIS DRAWING SHALL CONFORM TO THE PERTINENT REQUIREMENTS OF THE CONTRACT.

PAVEMENT TIES AND TIE BARS SHALL BE EPOXY COATED IN CONFORMANCE WITH SUBSECTION 505.2.6.2 OF THE STANDARD SPECIFICATIONS.

UNLESS OTHERWISE SHOWN ON THE TYPICAL CROSS SECTIONS, THE BASE AGGREGATE AND COMMON EXCAVATION LIMITS ARE 2' - 0" BEHIND THE BACK OF CURBS.

- ① TIE BARS ARE REQUIRED FOR CURB AND GUTTERS TYPES A, G, K, R, AND TBTT.
- ② THE BOTTOM OF CURB AND GUTTER MAY BE CONSTRUCTED EITHER LEVEL OR PARALLEL TO THE SLOPE OF THE SUBGRADE OR BASE AGGREGATE PROVIDED A 6" MINIMUM GUTTER THICKNESS IS MAINTAINED.
- ⑨ REFER TO SDD 08D18 AND 08D19 FOR ADDITIONAL DRIVEWAY ENTRANCE CURB DETAILS.

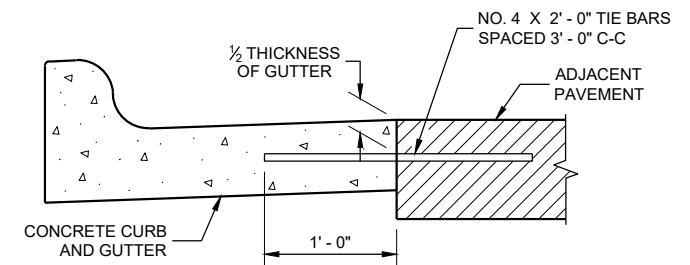

TYPICAL TIE BAR LOCATION ①

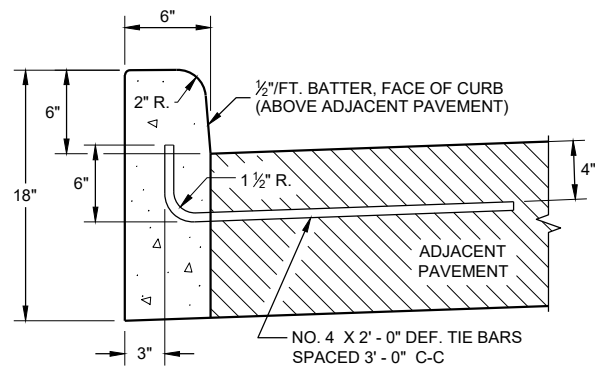

TYPES A ① & D

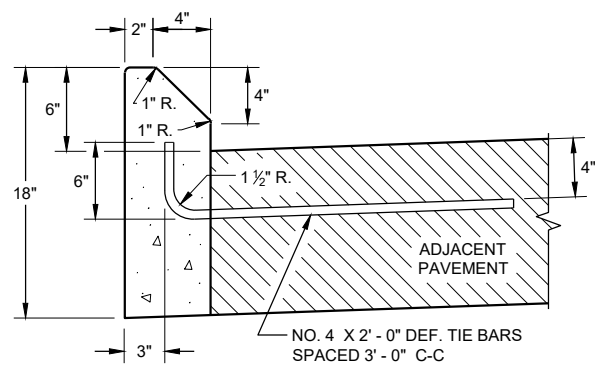

TYPES G ① & J

CONCRETE CURB

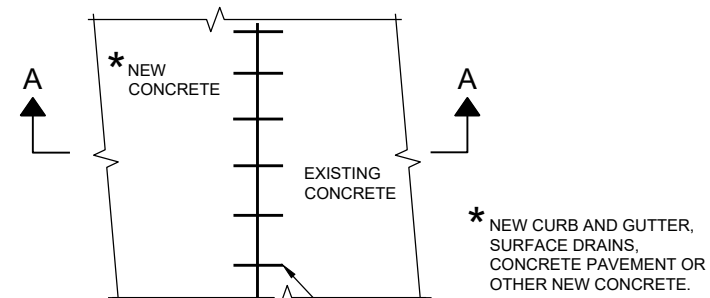

PLAN VIEW

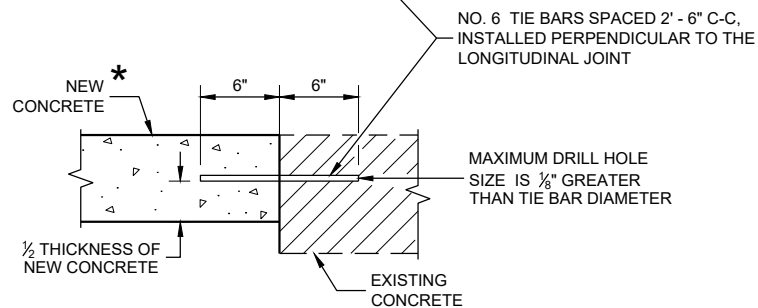

SECTION A - A

TIE BARS DRILLED INTO EXISTING PAVEMENT

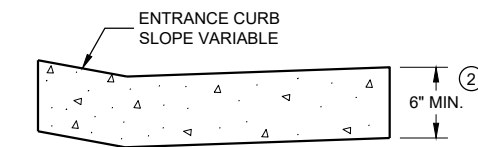

DRIVEWAY ENTRANCE CURB ⑨
(WHEN DIRECTED BY THE ENGINEER)

CONCRETE CURB, TIES AND CURB AND GUTTER APPLICATIONS

STATE OF WISCONSIN
DEPARTMENT OF TRANSPORTATION

APPROVED
February 2021 /S/ Rodney Taylor
DATE ROADWAY STANDARDS DEVELOPMENT
ENGINEER

FHWA

NOTE: TAPER CURB ENDS TO GUTTER IN 1' - 0"

ASPHALTIC FLUME

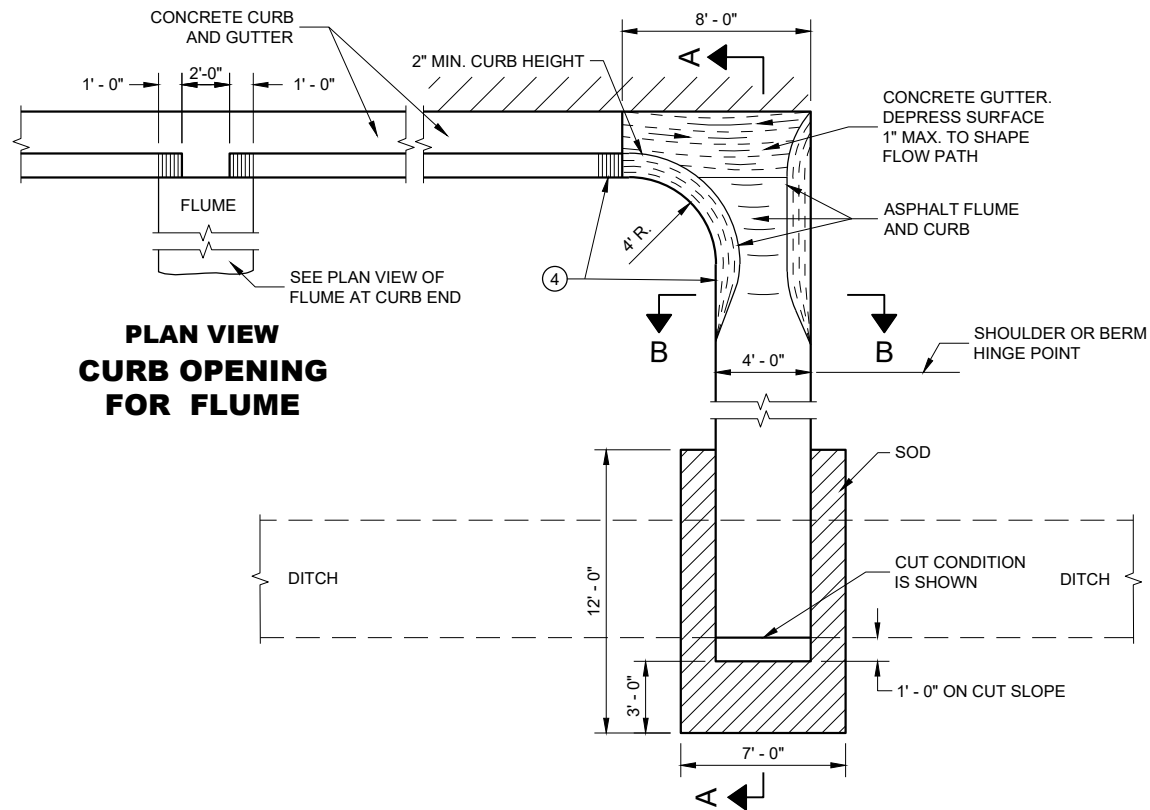

**PLAN VIEW
CURB OPENING
FOR FLUME**

**PLAN VIEW
FLUME AT CURB END**

GENERAL NOTES

DETAILS OF CONSTRUCTION, MATERIALS AND WORKMANSHIP NOT SHOWN ON THIS DRAWING SHALL CONFORM TO PERTINENT REQUIREMENTS OF THE STANDARD SPECIFICATIONS AND APPLICABLE SPECIAL PROVISIONS.

4" X 4" - W3.0 X W3.0 CONCRETE REINFORCEMENT SHALL BE IN ACCORDANCE WITH AASHTO SPECIFICATION M55.

- ① JOINTS SHALL BE 1/8" TO 1/4" WIDE BY 1 1/2" DEEP AND SPACED AT UNIFORM INTERVALS OF APPROXIMATELY 4 FEET.
- ② GEOTEXTILE TYPE "R" SHALL UNDERLAY THE FULL LENGTH AND WIDTH OF THE CONCRETE SURFACE DRAIN AND RIPRAP.
- ③ CONCRETE SURFACE DRAIN WITHOUT CURB AND GUTTER MAY BE USED ON BACKSLOPES WHEN SPECIFIED.
- ④ ANGLE OF FLUME IN RELATION TO BACK OF CURB TO BE CONSTRUCTED PER THE PLAN DETAILS OR AS DIRECTED BY THE ENGINEER. ANGLE OF FLUME MAY BE OTHER THAN 90 DEGREES AS SHOWN.

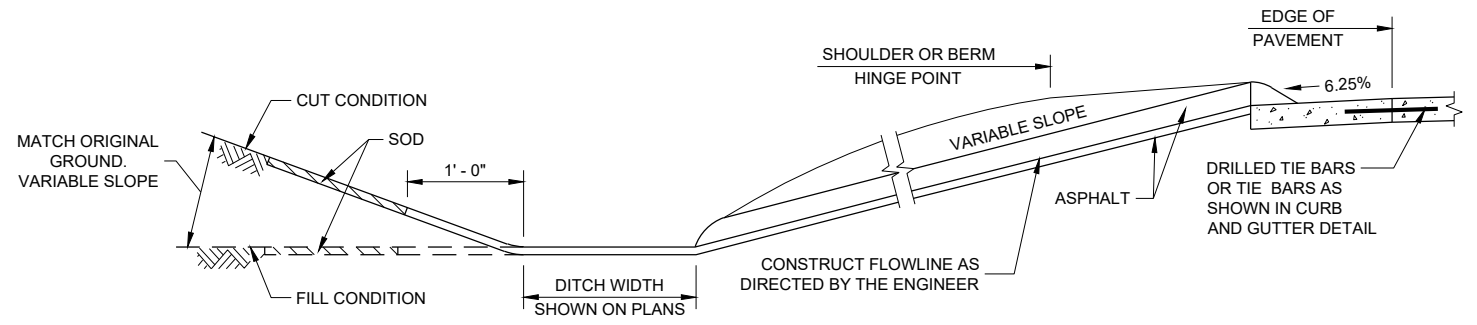

SECTION A - A

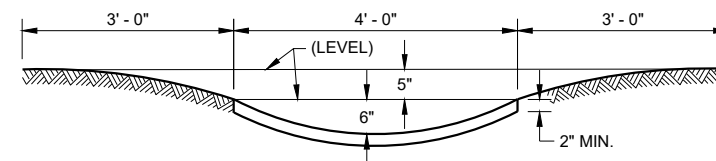

SECTION B - B

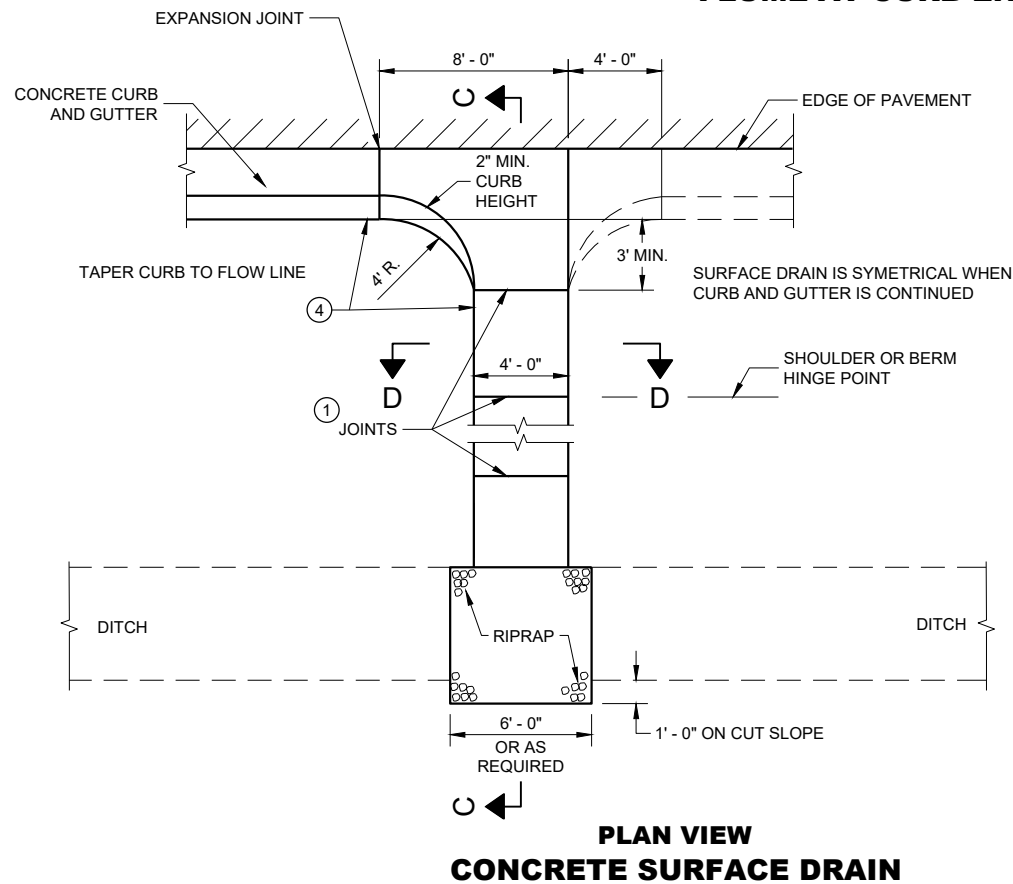

**PLAN VIEW
CONCRETE SURFACE DRAIN**

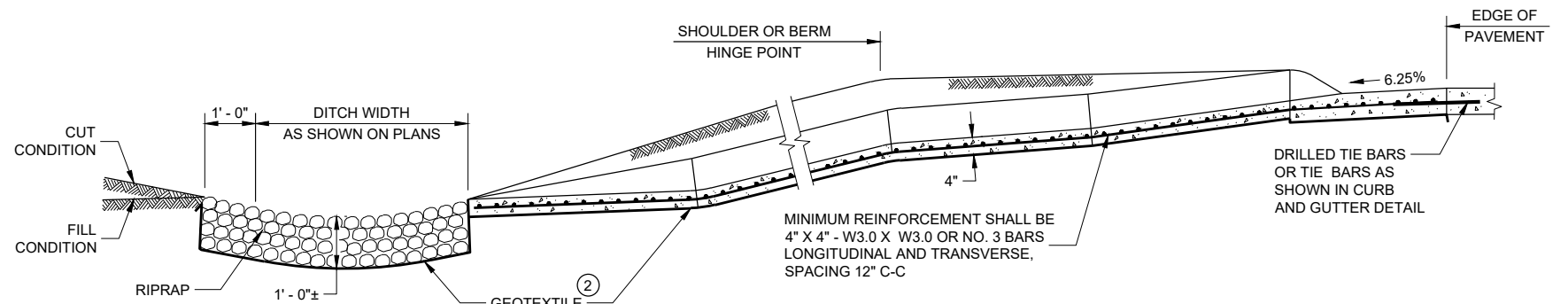

SECTION C - C

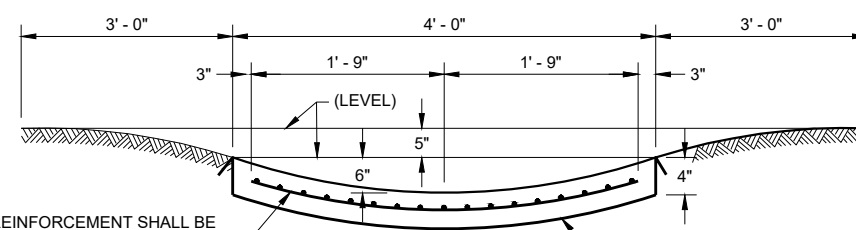

SECTION D - D

MINIMUM REINFORCEMENT SHALL BE 4" X 4" - W3.0 X W3.0 OR NO. 3 BARS LONGITUDINAL AND TRANSVERSE, SPACING 12" C-C

MINIMUM REINFORCEMENT SHALL BE 4" X 4" - W3.0 X W3.0 OR NO. 3 BARS LONGITUDINAL AND TRANSVERSE, SPACING 12" C-C

CONCRETE SURFACE DRAINS AND ASPHALTIC FLUMES

STATE OF WISCONSIN
DEPARTMENT OF TRANSPORTATION

APPROVED
November 2021 /S/ Rodney Taylor
DATE ROADWAY STANDARDS DEVELOPMENT
ENGINEER

FHWA

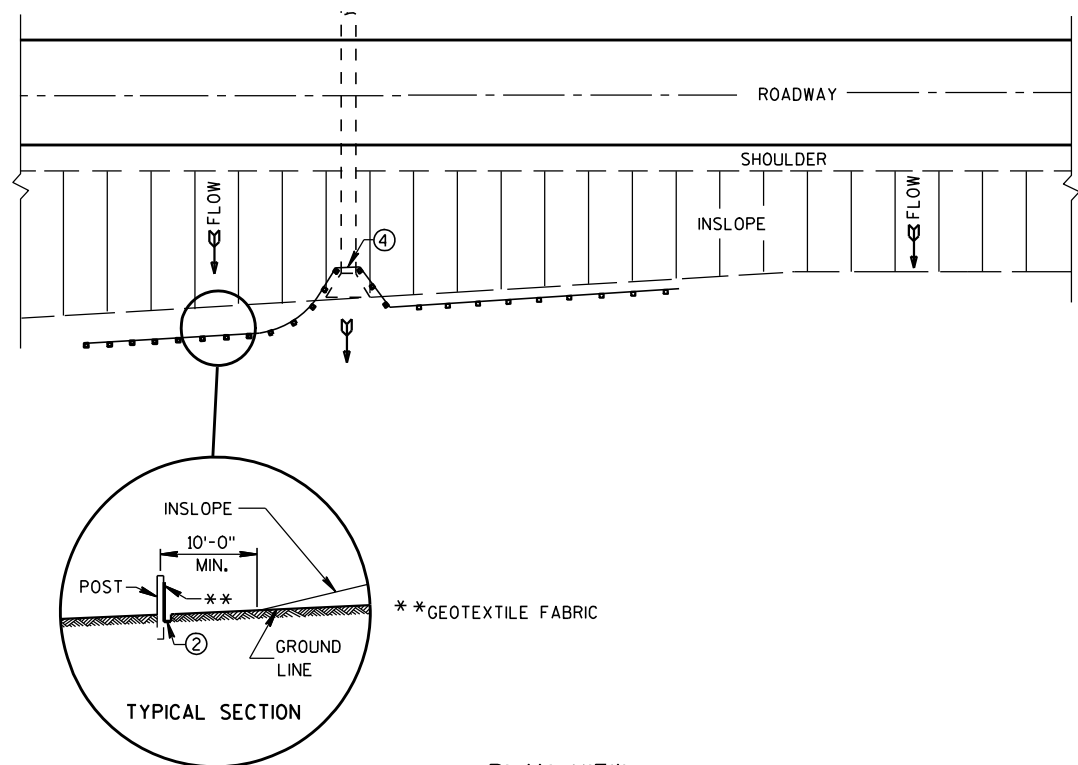

PLAN VIEW
TYPICAL APPLICATION OF SILT FENCE

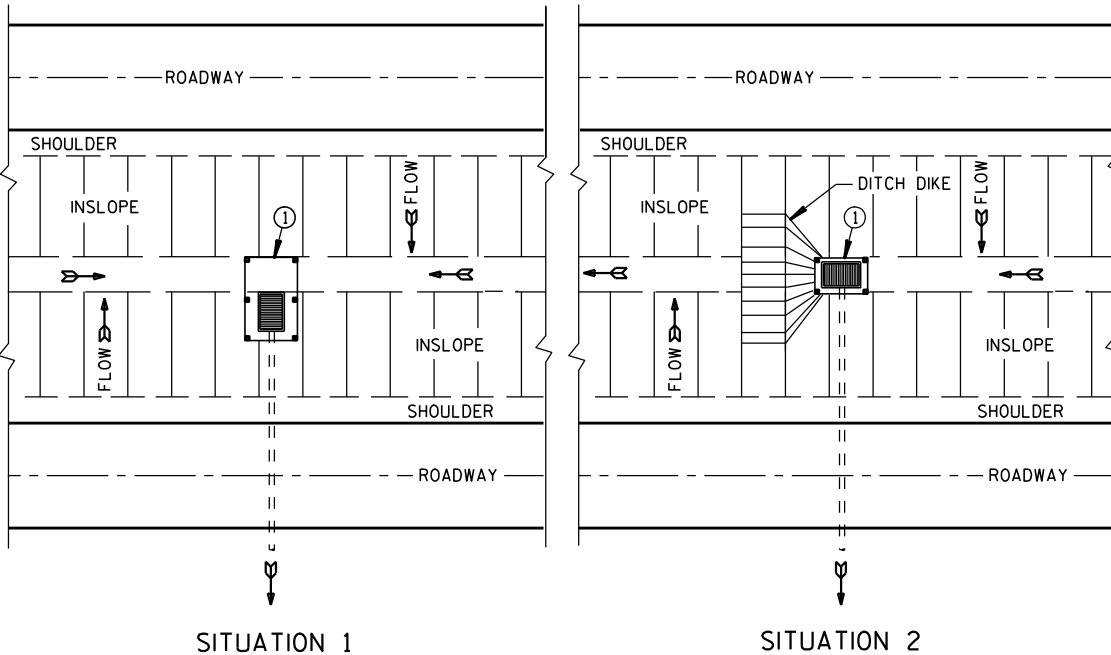

SITUATION 1 SITUATION 2
PLAN VIEW
SILT FENCE AT MEDIAN SURFACE DRAINS

GENERAL NOTES

DETAILS OF CONSTRUCTION NOT SHOWN ON THIS DRAWING SHALL CONFORM TO THE PERTINENT REQUIREMENTS OF THE STANDARD SPECIFICATIONS AND APPLICABLE SPECIAL PROVISIONS.

- ① HORIZONTAL BRACE REQUIRED WITH 2" X 4" WOODEN FRAME OR EQUIVALENT AT TOP OF POSTS.
- ② FOR MANUAL INSTALLATIONS THE TRENCH SHALL BE A MINIMUM OF 4" WIDE & 6" DEEP TO BURY AND ANCHOR THE GEOTEXTILE FABRIC. FOLD MATERIAL TO FIT TRENCH AND BACKFILL & COMPACT TRENCH WITH EXCAVATED SOIL.
- ③ WOOD POSTS SHALL BE A MINIMUM SIZE OF 1 1/8" X 1 1/8" OF OAK OR HICKORY.
- ④ SILT FENCE TO EXTEND ACROSS THE TOP OF THE PIPE.
- ⑤ CONSTRUCT SILT FENCE FROM A CONTINUOUS ROLL IF POSSIBLE BY CUTTING LENGTHS TO AVOID JOINTS. IF A JOINT IS NECESSARY USE ONE OF THE FOLLOWING TWO METHODS; A) OVERLAP THE END POSTS AND TWIST, OR ROTATE, AT LEAST 180 DEGREES, B) HOOK THE END OF EACH SILT FENCE LENGTH.

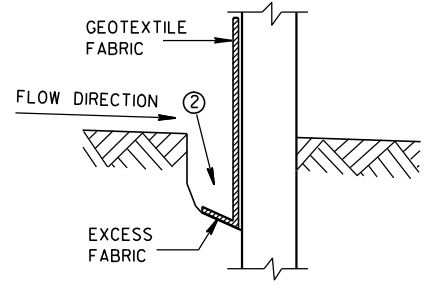

TRENCH DETAIL

NOTE: ADDITIONAL POST DEPTH OR TIE BACKS MAY BE REQUIRED IN UNSTABLE SOILS

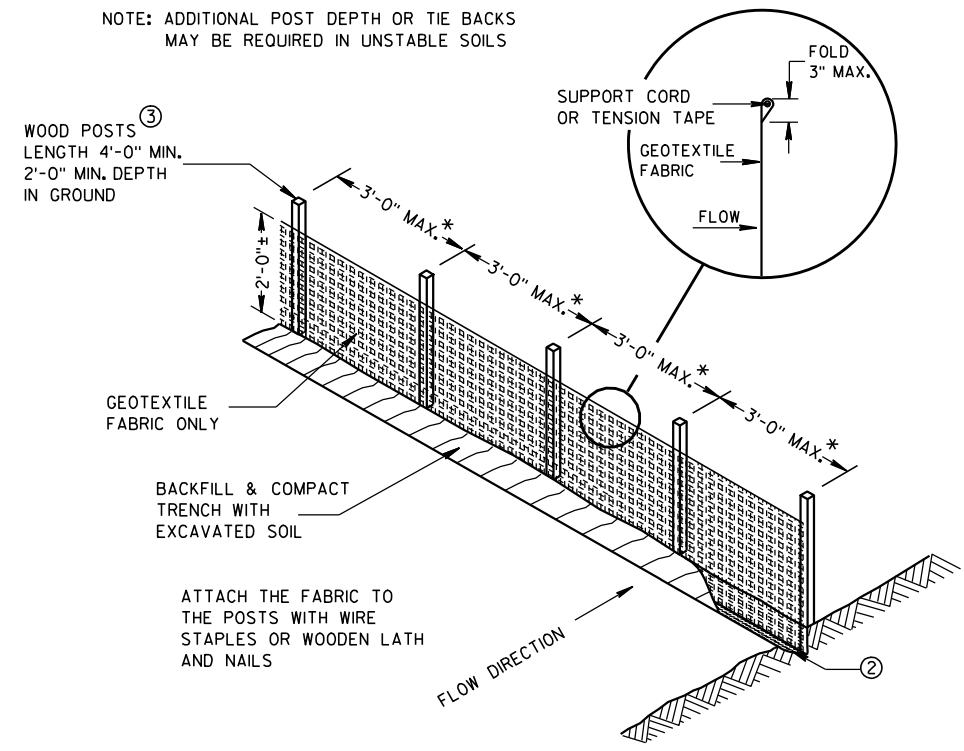

SILT FENCE

* NOTE: 8'-0" POST SPACING ALLOWED IF A WOVEN GEOTEXTILE FABRIC IS USED.

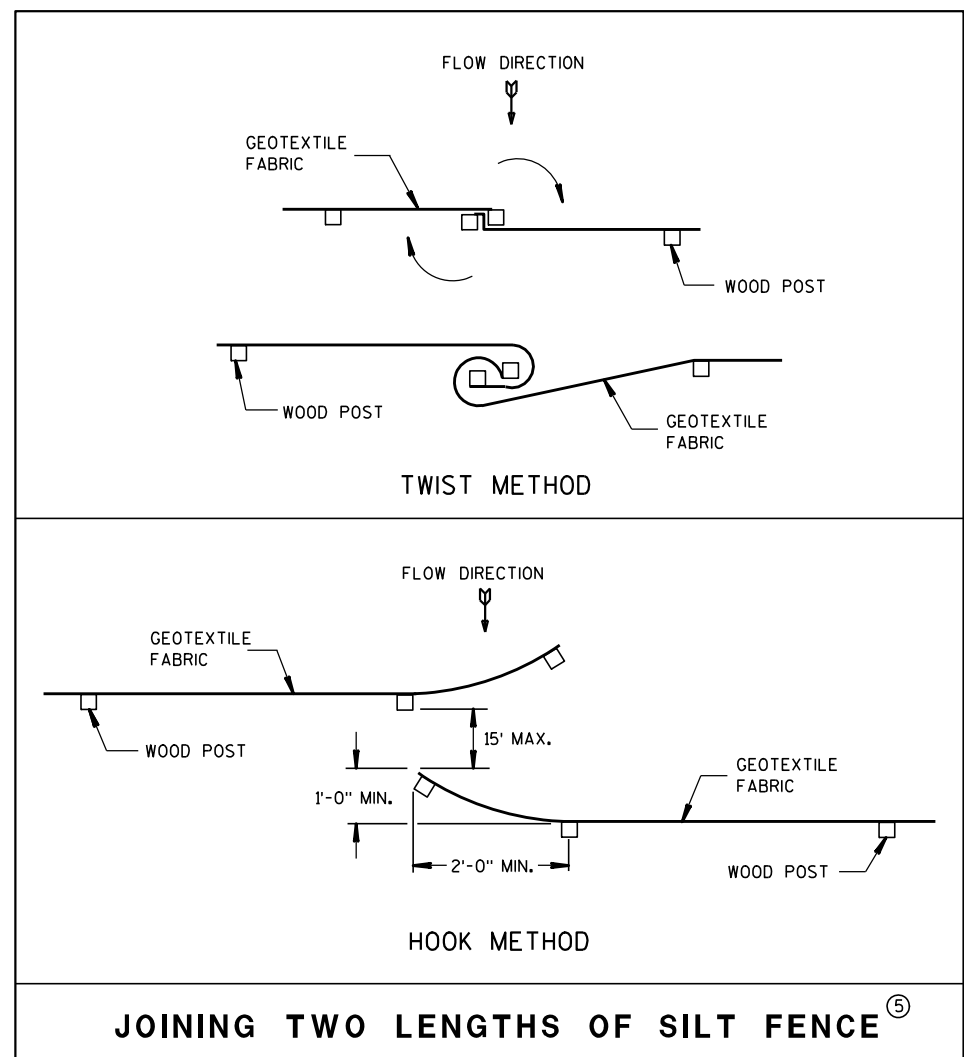

JOINING TWO LENGTHS OF SILT FENCE ⑤

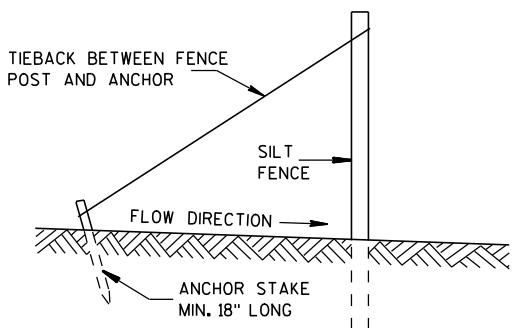

SILT FENCE TIE BACK
(WHEN REQUIRED BY THE ENGINEER)

SILT FENCE	
STATE OF WISCONSIN DEPARTMENT OF TRANSPORTATION	
APPROVED 4-29-05 DATE	/S/ Beth Canestra CHIEF ROADWAY DEVELOPMENT ENGINEER
FHWA	

GENERAL NOTES

THIS DETAIL IS TYPICAL FOR CLOSING THE RIGHT SHOULDER. FOR CLOSING THE LEFT SHOULDER, REVERSE THE TRAFFIC CONTROL.

THIS DETAIL MAY BE USED FOR DIVIDED ROADWAYS WITH ANY NUMBER OF TRAVEL LANES.

THE EXACT NUMBER, LOCATION AND SPACING OF ALL SIGNS AND DEVICES SHALL BE ADJUSTED TO FIT FIELD CONDITIONS AS APPROVED BY THE ENGINEER.

ALL SIGNS ARE 48" X 48" UNLESS OTHERWISE NOTED.

SIGN LAYOUTS SHALL BE IN ACCORDANCE WITH THE FHWA'S MANUAL OF STANDARD HIGHWAY SIGNS OR THE WISCONSIN STANDARD SIGN PLATES.

SIGNS THAT WILL BE IN PLACE LESS THAN 7 CONTINUOUS DAYS AND NIGHTS MAY BE MOUNTED ON PORTABLE SUPPORTS.

ANY SIGNS TEMPORARY OR EXISTING, WHICH CONFLICT WITH TRAFFIC CONTROL "IN USE" SHALL BE REMOVED OR COVERED AS NEEDED AND AS APPROVED BY THE ENGINEER.

CHANNELIZING DEVICES PLACED ADJACENT TO THE WORK AREA SHALL BE PULLED BACK FROM THE TRAVEL LANE WHEN WORK IS NOT IN PROGRESS.

WHEN A RAMP INTERSECTS THE FACILITY ON WHICH THE WORK IS BEING PERFORMED, ADDITIONAL TRAFFIC CONTROLS SHALL BE PROVIDED AS SPECIFIED IN THE PLANS AND/OR THE SPECIAL PROVISIONS OR AS APPROVED BY THE ENGINEER.

*FOR SHORT DURATION SHOULDER WORK OF LESS THAN ONE HOUR, THE W21-50 SIGN MAY BE OMITTED.





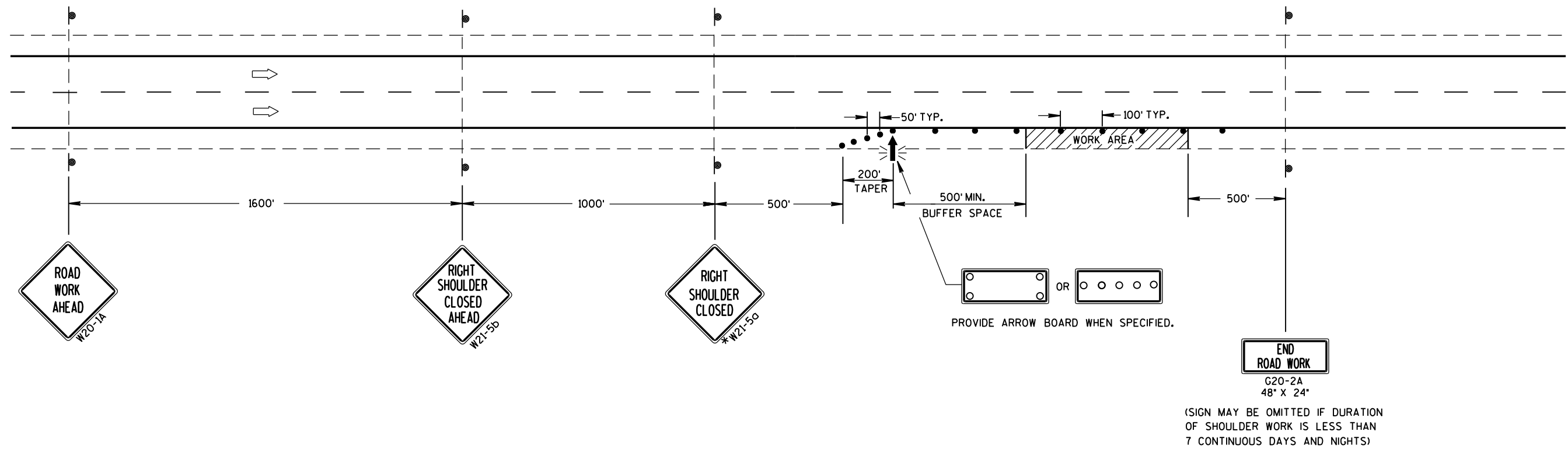

LEGEND

- TRAFFIC CONTROL DRUM
- ⊙ SIGN ON PERMANENT SUPPORT
- ➡ DIRECTION OF TRAFFIC
- ⚡ FLASHING ARROW BOARD
- ▨ WORK AREA



TRAFFIC CONTROL SHOULDER CLOSURE ON DIVIDED ROADWAY, SPEEDS GREATER THAN 40 MPH	
STATE OF WISCONSIN DEPARTMENT OF TRANSPORTATION	
APPROVED June 2016 DATE	/s/ Peter Amakobe Atepe STATEWIDE WORK ZONE TRAFFIC SAFETY ENGINEER
FHWA	

LEGEND

-  TYPE III BARRICADE WITH ATTACHED SIGN
-  SIGN ON PERMANENT SUPPORT
-  TRAFFIC CONTROL DRUM
-  TRAFFIC CONTROL DRUM WITH TYPE "C" STEADY BURN LIGHT
-  TYPE "A" WARNING LIGHT (FLASHING)
-  DIRECTION OF TRAFFIC
-  WORK AREA

POSTED SPEED LIMIT PRIOR TO WORK STARTING (MPH)	ADVANCE WARNING SIGN SPACING (A) FEET	SHIFTING TAPER $L/2$					
		W, LATERAL OFFSET (FT)					
		3	4	5	6	7	8
25	200	10	14	17	21	24	28
30	200	15	20	25	30	35	40
35	350	20	27	34	40	47	54
40	350	26	35	44	53	62	70
45	500	45	59	74	89	104	119
50	500	50	66	83	99	116	132
55	500	54	73	91	109	127	145

GENERAL NOTES

THE EXACT NUMBER, LOCATION, AND SPACING OF ALL SIGNS AND DEVICES SHALL BE ADJUSTED TO FIT FIELD CONDITIONS AS APPROVED BY THE ENGINEER.

ALL SIGNS ARE 48"x48" UNLESS OTHERWISE NOTED. IF NECESSARY DUE TO SPACE CONSTRAINTS IN URBAN AREAS, 36"x36" SIGNS MAY BE USED IF APPROVED BY THE REGIONAL TRAFFIC UNIT.

"WO" IS THE SAME AS "W" EXCEPT THE BACKGROUND IS ORANGE.

ANY SIGNS TEMPORARY OR EXISTING, WHICH CONFLICT WITH TRAFFIC CONTROL "IN USE" SHALL BE REMOVED OR COVERED AS NEEDED AND AS APPROVED BY THE ENGINEER.

CHANNELIZING DEVICES PLACED ADJACENT TO WORK AREA SHALL BE PULLED BACK FROM THE TRAVEL LANE WHEN WORK IS NOT IN PROGRESS.

SIGNS THAT WILL BE IN PLACE LESS THAN 7 CONTINUOUS DAYS AND NIGHTS MAY BE MOUNTED ON PORTABLE SUPPORTS.

W20-1 AND G20-2A SIGNS ARE NOT REQUIRED IF THE WORK AREA IS WITHIN A LARGER WORK ZONE WHERE THESE SIGNS ARE ALREADY PRESENT. G20-2A SIGNS MAY ALSO BE OMITTED IF DURATION WORK IS LESS THAN SEVEN CONTINUOUS DAYS AND NIGHTS.

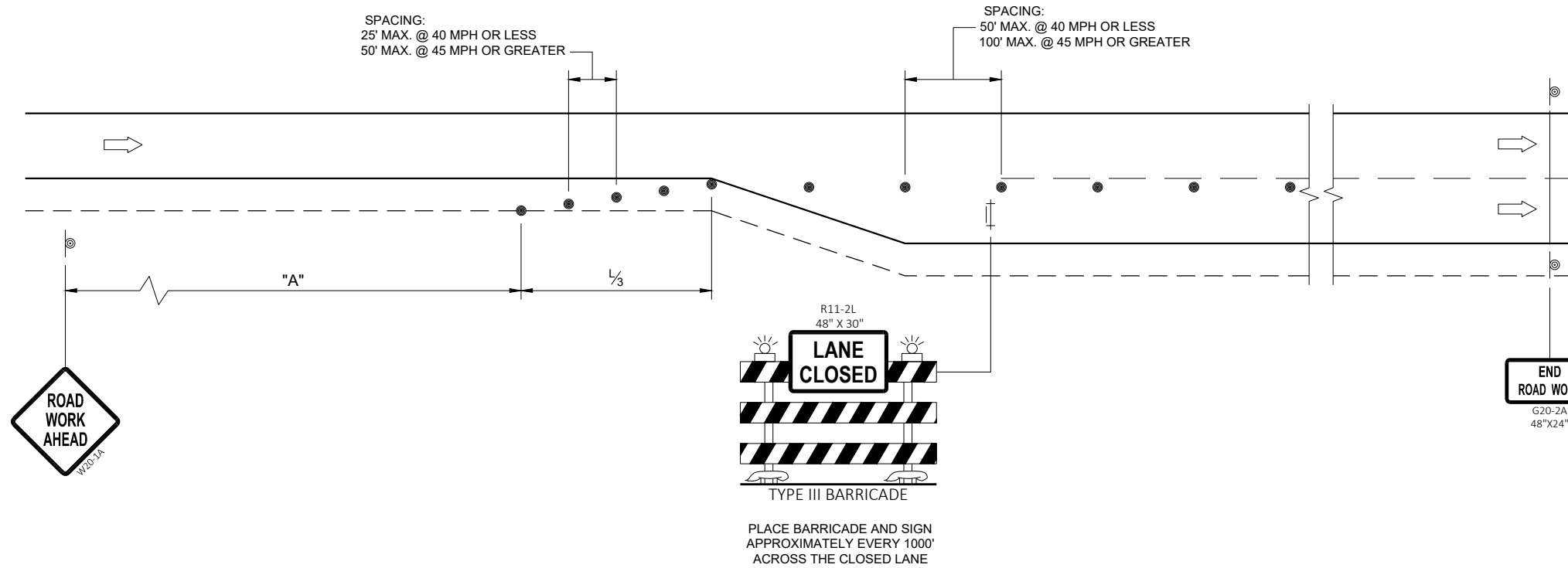

6

6

SDD 15D50 - 02a

SDD 15D50 - 02a

TRAFFIC CONTROL ADDED LANE CLOSURE WITHOUT LANE SHIFT	
STATE OF WISCONSIN DEPARTMENT OF TRANSPORTATION	
APPROVED February 2022 DATE	/S/ Andrew Heidtke WORK ZONE ENGINEER
FHWA	

TYPICAL ASSEMBLIES

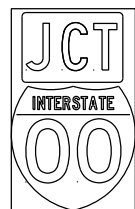

J1-1

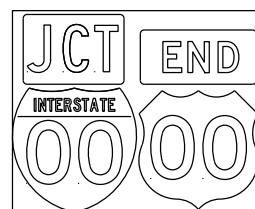

J1-2

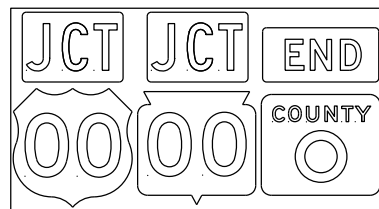

J1-3



JR1-1

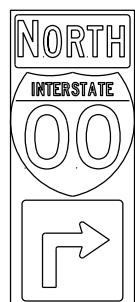

J2-1

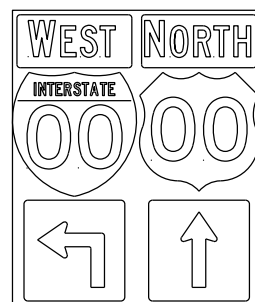

J2-2

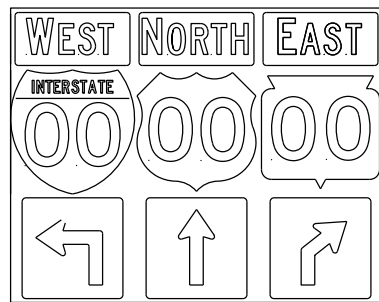

J2-3

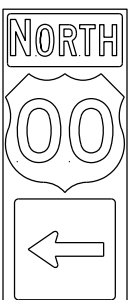

J3-1

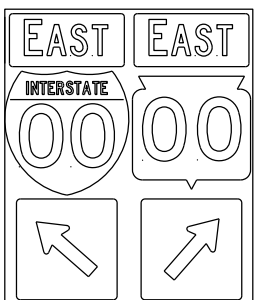

J3-2

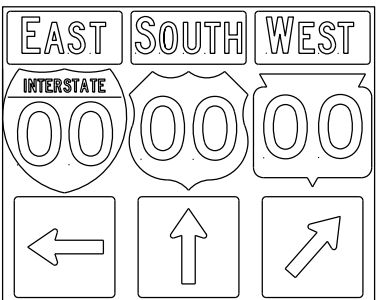

J3-3

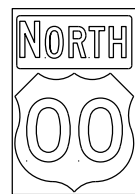

J4-1

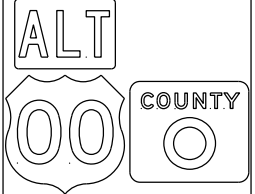

J4-2

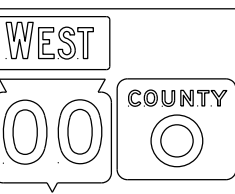

J4-2



J12-1

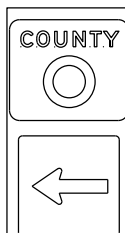

J13-1

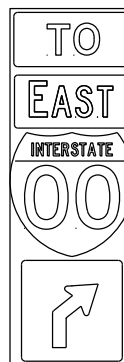

J32-1

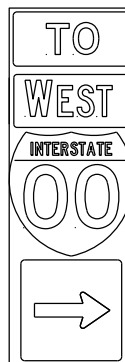

J33-1

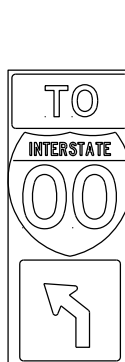

J22-1

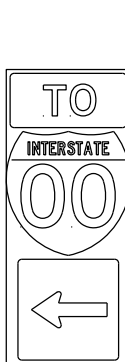

J23-1



JR13-1



JR23-1



JR99-1



JV

(Typical Vertical J-Assembly See Note 10 and 11)

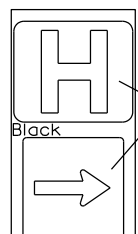

JH-1

Blue Background

blue background with interstate

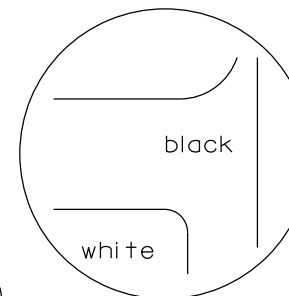
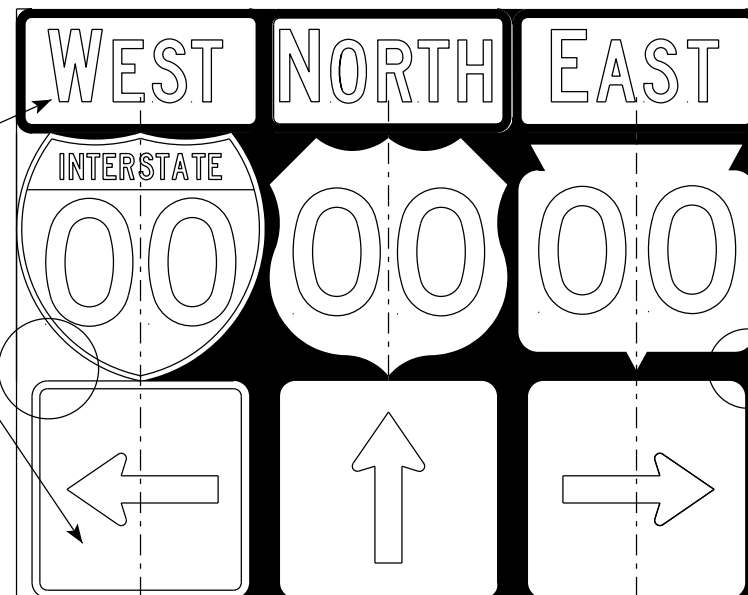
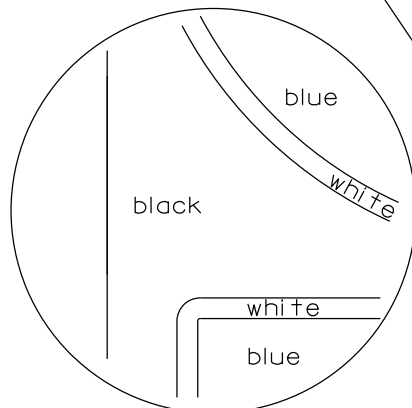

black background

NOTES

- Signs are Type II - Type H Reflective
- Color:
 - Background - Black Non-reflective
 - Message - see Note 5
- Message Series - See Note 5
- Corners shall be square or rounded if base material is plywood. If base material is metal the corners shall be rounded.
- The colors and message spacing on each marker shall be according to the applicable route marker panel specifications.
- Certain marker heads require the component pieces to be the same color. As an example, all the components used with an MI-1 Interstate marker shall be blue.
- Single panel j-assemblies shall only be used with route marker shields that are same size. If the route marker shields are different size use multiple piece component.
- Route assemblies that have 24 inch route shields and have dimensions greater than 48 inches (both vertical and horizontal) shall have one horizontal splice between the arrows and route shields. Vertical splices shall not be used on route assemblies with a horizontal dimension of 144 inches or less. The contractor shall not use more than one vertical joint per sign and the joint shall be between route shields.
- Route assemblies that have 36 inch shields and have dimensions greater than 48 inches (both vertical and horizontal) shall have two horizontal splices. One horizontal splice shall be between the cardinal direction and route shields and the other horizontal splice shall be between the arrows and route shields. Vertical splices shall not be used on route assemblies with a horizontal dimension of 144 or less. The contractor shall not use more than one vertical joint per sign and the joint shall be between route shields.
- All Vertical J Assemblies are given a Sign Code of JV
- For JV Assemblies that have a mixture of Interstate and non Interstate shields, arrows and cardinals shall be white on blue.

ROUTE MARKERS & COMPONENTS IN TYPICAL ASSEMBLIES

WISCONSIN DEPT OF TRANSPORTATION

APPROVED

Matthew R. Rauch
for State Traffic Engineer

DATE 3/18/21

PLATE NO. A2-1S.9

PROJECT NO:

SHEET NO:

E

URBAN AREA

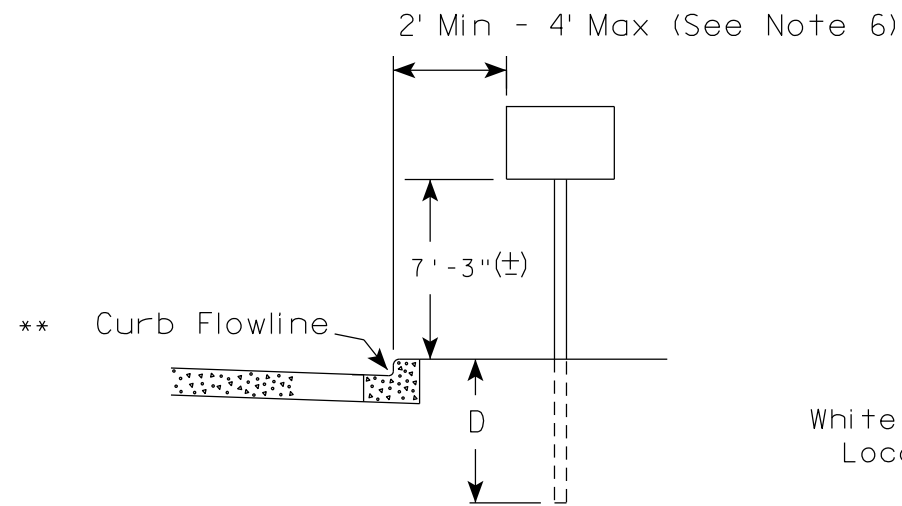

RURAL AREA (See Note 2)

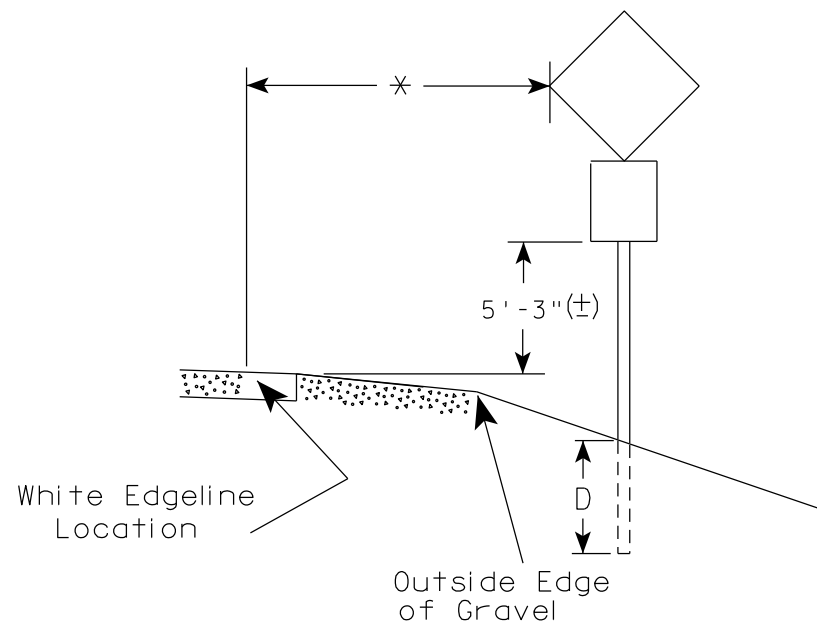
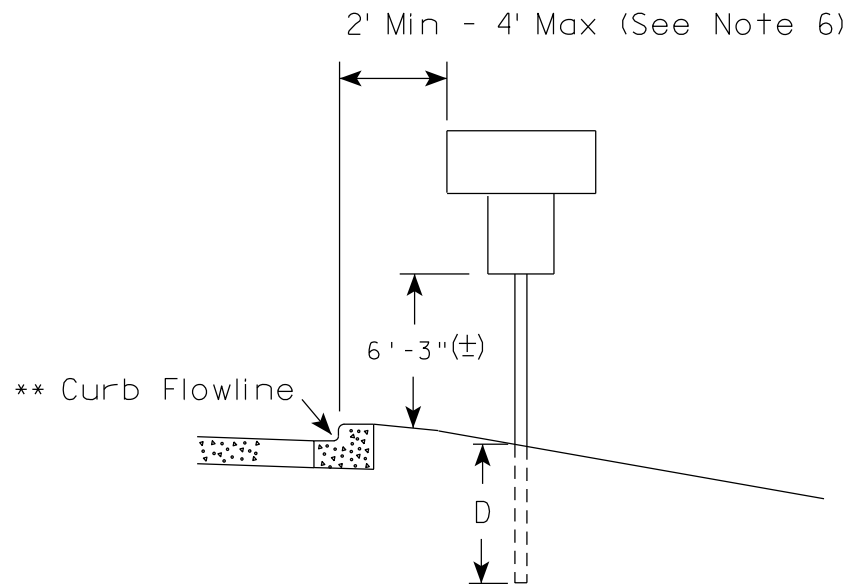
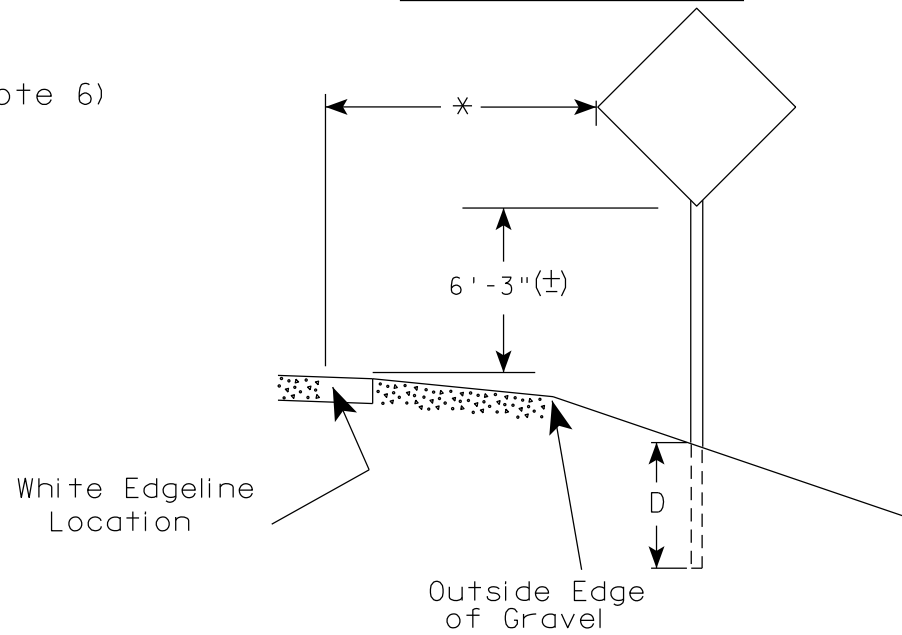

GENERAL NOTES

1. Signs wider than 4 feet or 20 sq.ft or larger, shall be mounted on multiple posts. Refer to plate A4-4.
2. If signs are mounted on or behind barrier wall, see A4-10 sign plate.
The Double Arrow sign (W12-1D) shall be mounted at a height of 2'-3" (±). The Chevron sign (W1-8), Roundabout Chevron panel (R6-4B), Enhanced Reference Markers, Clearance Markers (W5-52), Mile Markers (D10 series), In Road Object Markers (W5-54) & End of Road Markers (W5-56) shall be mounted at a height of 4'-3" (±).
3. For expressways and freeways, mounting height is 7'- 3" (±) or 6'-3" (±) depending upon existence of a sub-sign.
4. Minimum mounting height for signs mounted on traffic signal poles is 5'- 3" (±).
5. Offset distance shall be consistent with existing signs or consistent throughout length of project.
6. The (±) tolerance for mounting height is 3 inches.
7. Folding signs shall be mounted at a height of 5'-3" (±) or as directed by the Engineer.

POST EMBEDMENT DEPTH

Area of Sign Installation (Sq. Ft.)	D (Min)
20 or Less	4'
Greater than 20	5'

* * The existence of curb and gutter does not in itself mandate the vertical clearance illustrated. That height is typically measured where there is sidewalk adjacent to the roadway or parking is permitted. In the absence of sidewalk vertical clearance is measured from the top of the curb. Offset of signs is measured from the flow line.

* 6 feet from edge of a paved shoulder or 12 feet from the edge of pavement (edge line location) or 2 feet from outside edge of gravel, whichever is greater unless directed by project engineer.

TYPICAL INSTALLATION OF PERMANENT TYPE II SIGNS ON SINGLE POSTS

WISCONSIN DEPT OF TRANSPORTATION

APPROVED *Matthew R. Rauch*
for State Traffic Engineer

DATE 5/13/2020 PLATE NO. A4-3.22

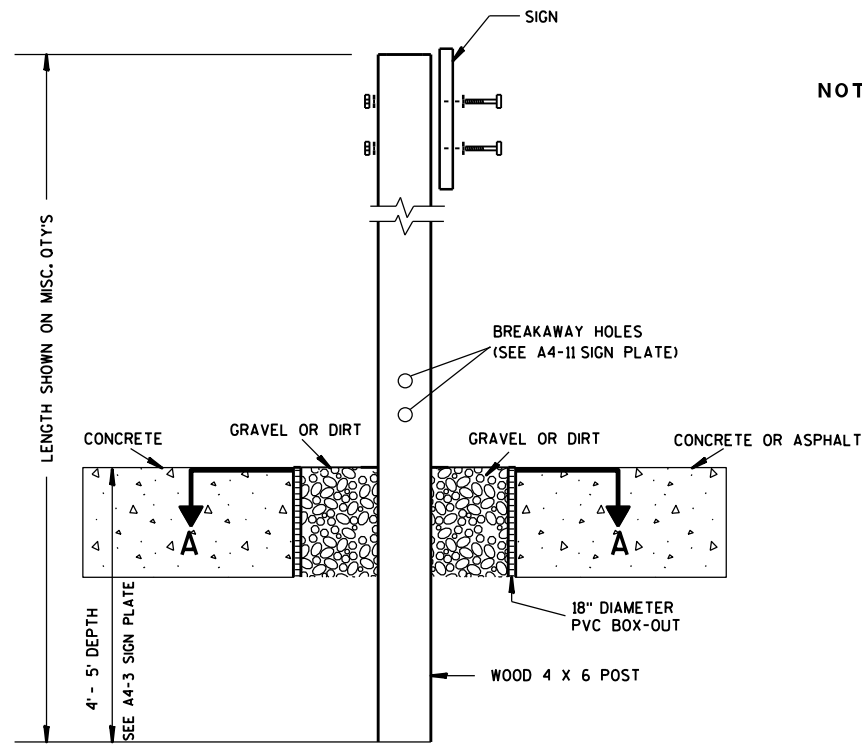

ELEVATION VIEW

DETAIL OF WOOD 4 X 6 SIGN POST IN BOX-OUT

- NOTES:**
1. ALL MATERIAL TO BE APPROVED BY ENGINEER PRIOR TO INSTALLATION
 2. SEE SIGN PLATE A4-8 FOR SIGN HARDWARE REQUIREMENTS
 3. 18 INCH X 18 INCH SQUARE BOX-OUTS MAY BE USED FOR INSTALLATIONS IN EXISTING CONCRETE OR ASPHALT LOCATIONS.

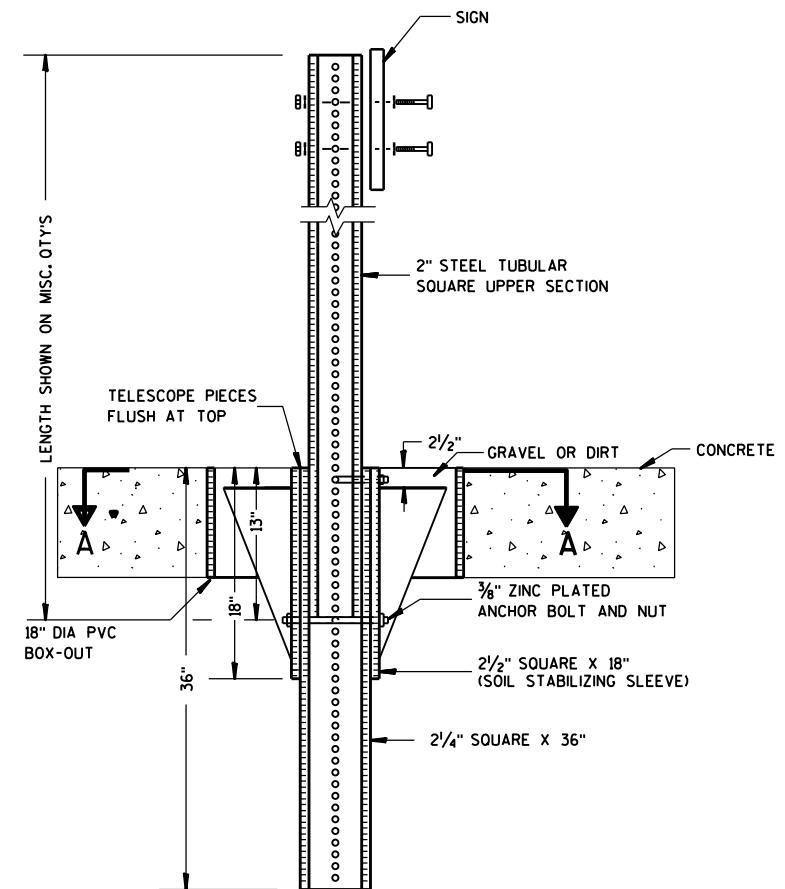

ELEVATION VIEW

DETAIL OF STEEL 2 X 2 SIGN POST IN BOX-OUT

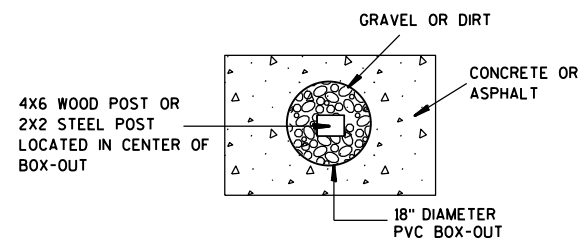

PLAN VIEW

FOR NEW CONCRETE/ ASPHALT INSTALLATIONS

SIGN POST BOX-OUTS A4-3B	
<small>WISCONSIN DEPT OF TRANSPORTATION</small>	
APPROVED <i>Matthew R. Rauch</i> <small>for State Traffic Engineer</small>	
<small>DATE 1/27/14</small>	<small>PLATE NO. A4-3B.1</small>

GENERAL NOTES

1. For 3 or 4 post installations, individual post spacing shall be greater than 3'-6".
2. See tables below for required number of posts.
3. For expressways and freeways, mounting height is 7'-3" (±) or 6'-3" (±) depending upon existence of sub-sign.
4. The (±) tolerance for mounting height is 3 inches.
5. J-Assemblies are considered to be one sign for mounting height.
6. Offset distance shall be consistent with existing signs or consistent throughout length of project.
7. Folding signs shall be mounted at a height of 5'-3" (±) or as directed by the engineer.
8. The Double Arrow sign (W12-1) shall be mounted at a height of 2'-3" (±). The Chevron sign (W1-8), Roundabout Chevron panel (R6-4B), Clearance Markers (W5-52), Mile Markers (D10 series), In Road Object Markers (W5-54) & End of Road Markers (W5-56) shall be mounted at a height of 4'-3" (±).

URBAN AREA

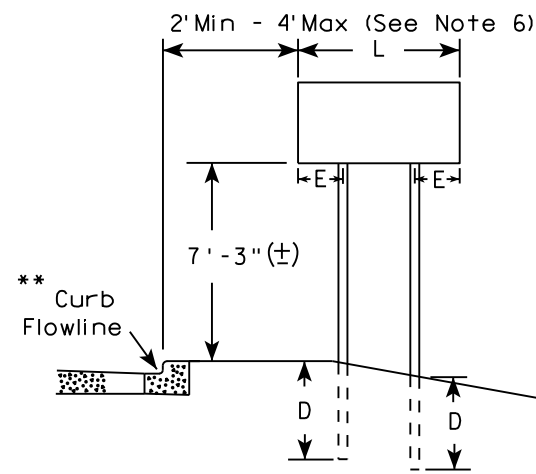

RURAL AREA (See Note 3)

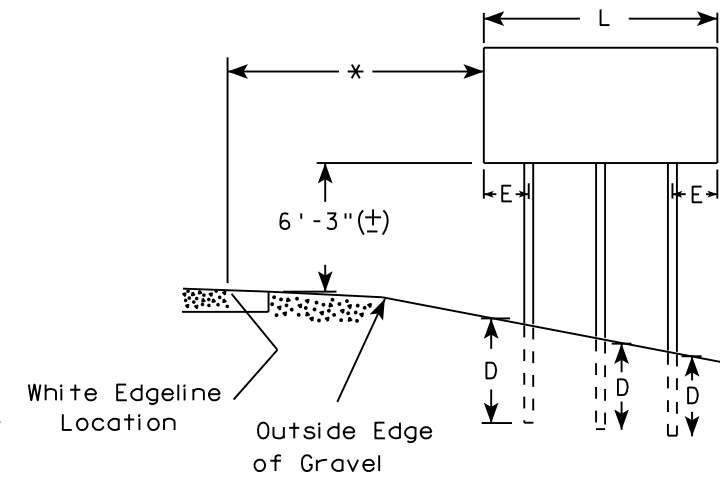
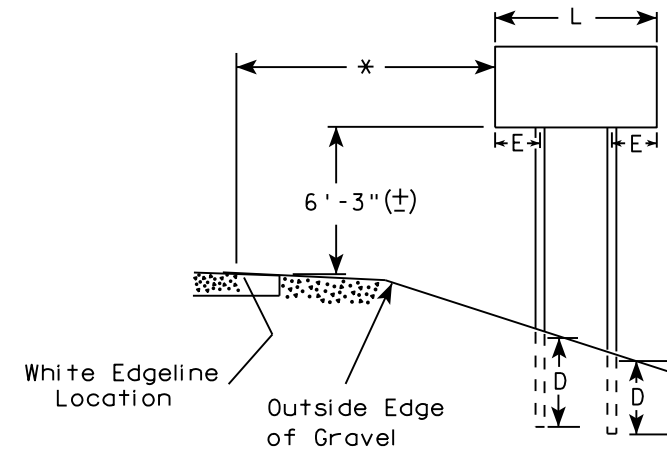

2' Min - 4' Max (See Note 6)

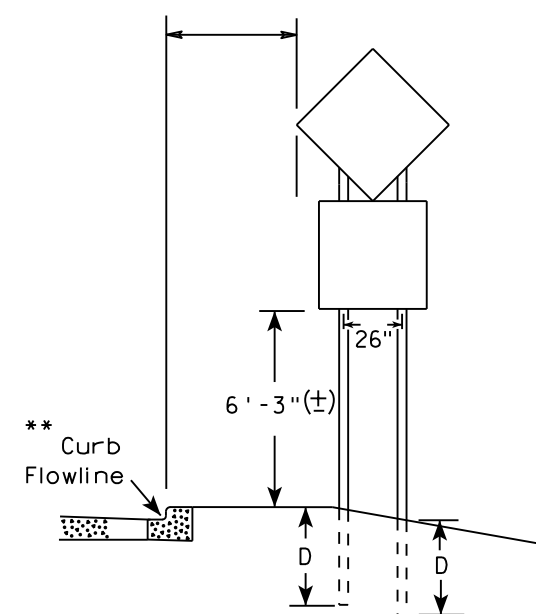

48" DIAMOND WARNING SIGN

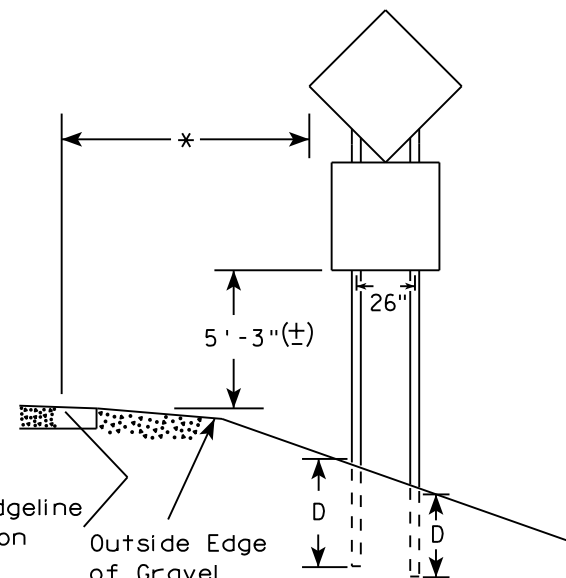

48" DIAMOND WARNING SIGN

* 6 feet from edge of a paved shoulder or 12 feet from the edge of pavement (edge line location) or 2 feet from outside edge of gravel, whichever is greater unless directed by project engineer.

** The existence of curb and gutter does not in itself mandate the vertical clearance illustrated. That height is typically measured where there is sidewalk adjacent to the roadway or parking is permitted. In the absence of sidewalk vertical clearance is measured from the top of the curb. Offset of signs is measured from the flow line.

*** See A4-3 sign plate for signs 4' or less in width and less than 20 S.F. in area.

SIGN SHAPE OTHER THAN DIAMOND (TWO POSTS REQUIRED)	
L	E
Greater than 48" Less than 60"	12"
60" to 108"	L/5

SIGN SHAPE OTHER THAN DIAMOND (THREE POSTS REQUIRED)	
L	E
Greater than 108" to 144"	12"

POST EMBEDMENT DEPTH

Area of Sign Installation (Sq. Ft.)	D (Min)
20 or Less	4'
Greater than 20	5'

TYPICAL INSTALLATION OF TYPE II SIGNS ON MULTIPLE POSTS

WISCONSIN DEPT OF TRANSPORTATION
 APPROVED *Matthew R. Rauch*
 For State Traffic Engineer
 DATE 8/21/17 PLATE NO. A4-4.15

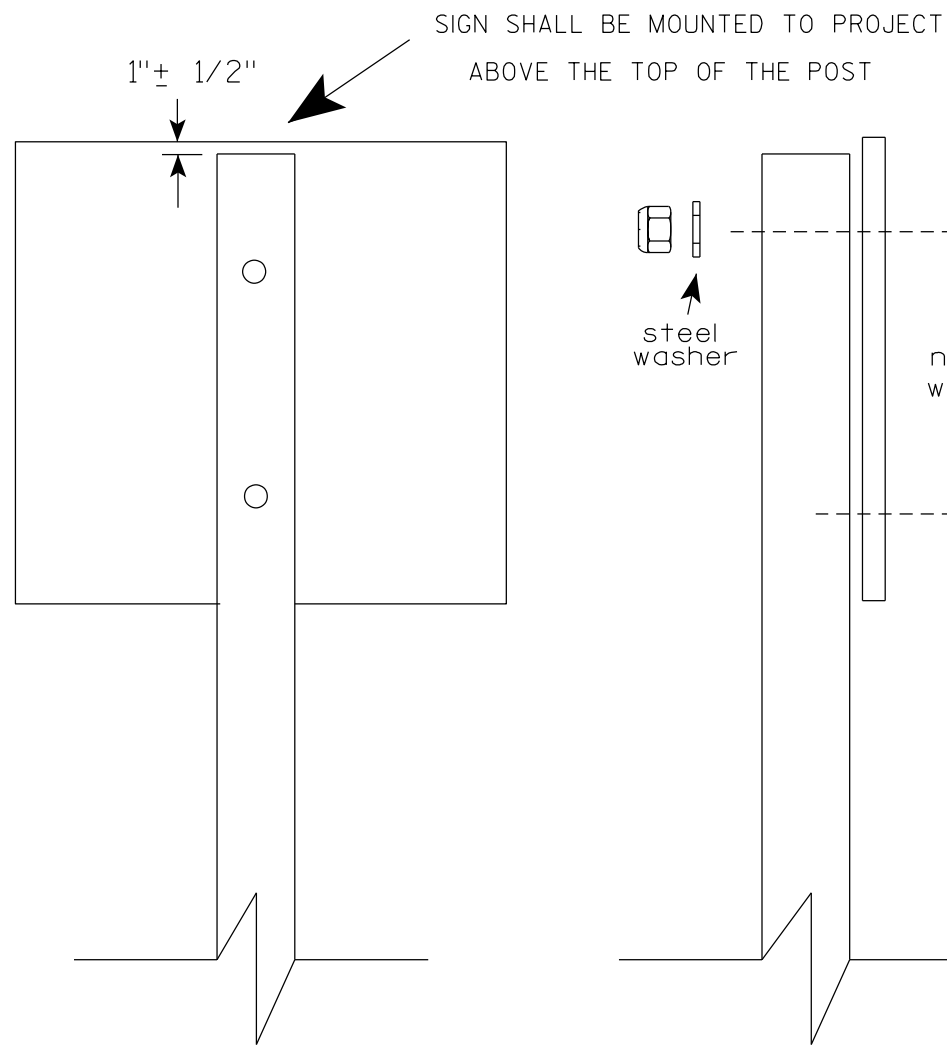

Nuts, bolts and lags used for mounting signs shall have hexagonal heads and shall be either :

- a. Hot dip galvanized in accordance with ASTM Designation: A 153, Class D, or SC 3
- b. Electro-galvanized in accordance with ASTM Designation : B 633, TYPE III, SC 3.

Threads on bolts and nuts shall be manufactured with sufficient allowance for the cadmium plate or galvanized coating to permit the nuts to run freely on the bolts.

STRINGER BOLTING TO ALUMINUM SIGNS (SEE SIGN PLATE A4-18)

MACHINE BOLTS - 5/16" X 1-3/4" Length w/ lock nuts

WOOD POSTS (4" x 6")

LAG SCREWS - 3/8" X 3" (NO STRINGERS ON BACK OF SIGN)
3/8" X 4" (STRINGERS ON BACK OF SIGN)

SQUARE STEEL POSTS (2" x 2")

MACHINE BOLTS - 3/8" X 3-1/4" Length w/ nuts (NO STRINGER ON BACK OF SIGN)
3/8" X 5" Length w/ nuts (STRINGERS ON BACK OF SIGN)

RIVETS - 9/32" (6605-9-6) BULB-TITE, TRI-FOLD, ALUMINUM BODY/MANDREL
O.D. FLANGE .720-.765 INCH, GRIP RANGE .042-.375 INCH

WASHERS (ALL POSTS) -

1-1/4" O.D. X 3/8" I.D. X 1/16" STEEL

1-1/4" O.D. X 3/8" I.D. X .080 NYLON

* Two different fastening systems are shown for illustration purposes. On any individual sign, either one or the other system shall be used. Actual number of fasteners per sign varies with the sign area, but normally there are two. For a single post installation, all signs greater than 9 sq. ft. require the use of 3 fasteners.

ATTACHMENT OF SIGNS
TO POSTS

WISCONSIN DEPT OF TRANSPORTATION

APPROVED *Matthew R Rauch*
For State Traffic Engineer

DATE 4/1/2020 PLATE NO. A4-8.9

**TELESCOPIC TUBING ANCHORS
TWO PIECE SYSTEM**

2 1/4" SQUARE
12 GAUGE
PERFORATED
GALVANIZED FINISH

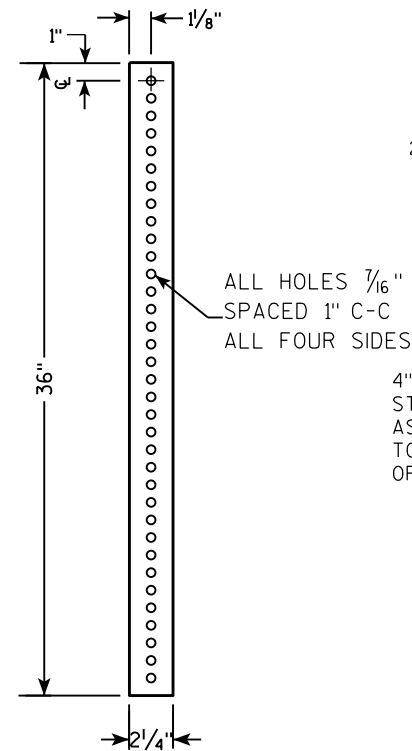

2 1/2" SQUARE
12 GAUGE
OMNI-DIRECTIONAL
PERFORATED
SOIL STABILIZING SLEEVE
GALVANIZED FINISH

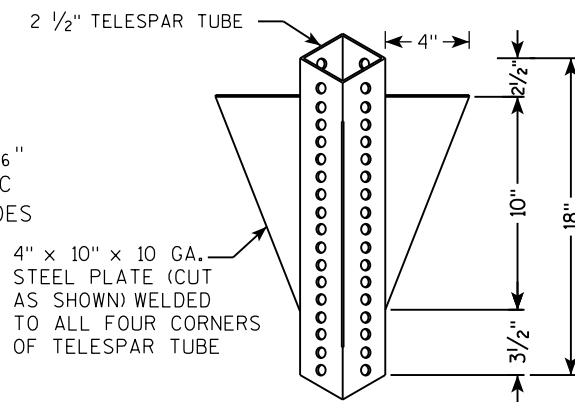

**DETAIL OF TUBULAR STEEL SIGN POST
(IN POURED CONCRETE OR ASPHALT)**

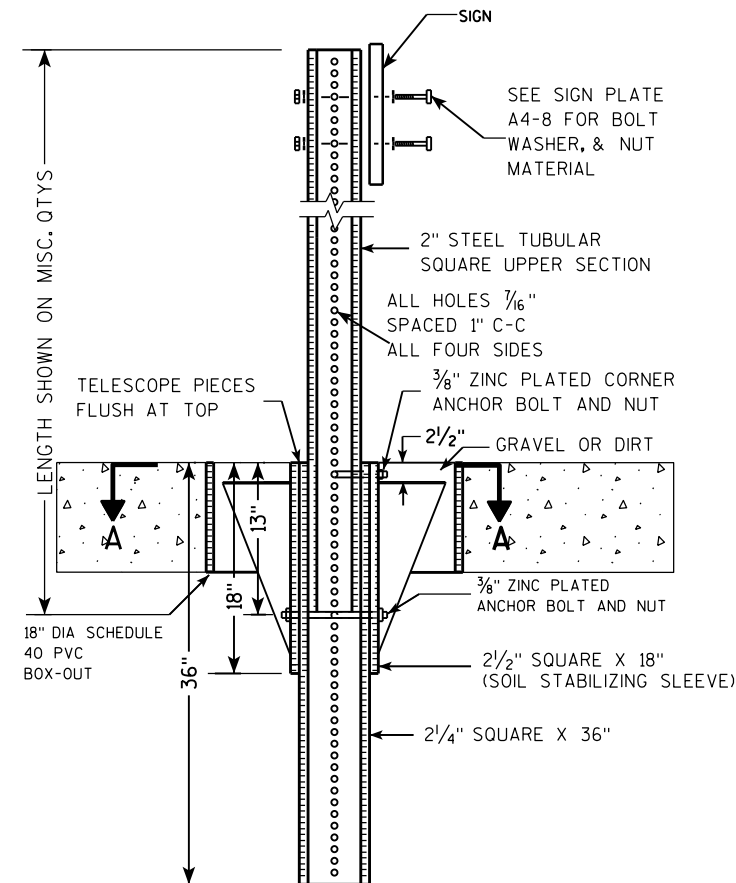

**DETAIL OF TUBULAR STEEL SIGN POST
(IN LOCATIONS OTHER THAN POURED CONCRETE OR ASPHALT)**

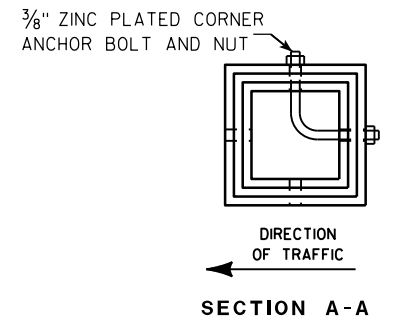
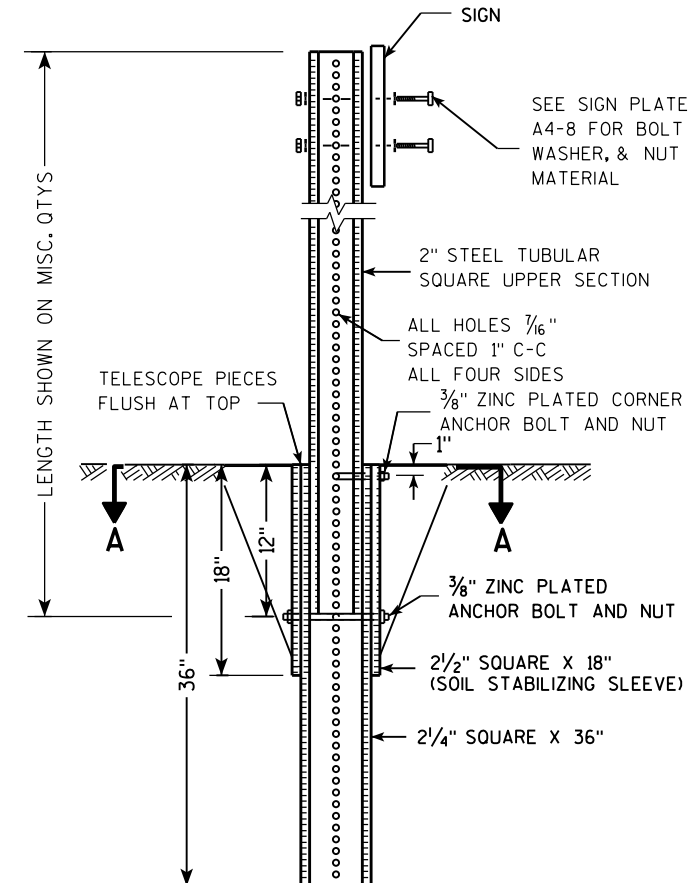

Area of Sign Installation (Sq. Ft.)	Number of Required Posts
9 or less	1
Greater than 9 less than or equal to 18	2
Greater than 18 less than or equal to 27	3

Signs wider than 3 feet or larger than 9 sq. ft shall be mounted on multiple posts (see above table).

**TUBULAR STEEL
SIGN POST
A4-9**

WISCONSIN DEPT OF TRANSPORTATION

APPROVED *Matthew R. Rauch*
for State Traffic Engineer

DATE 2/05/15 PLATE NO. A4-9.9

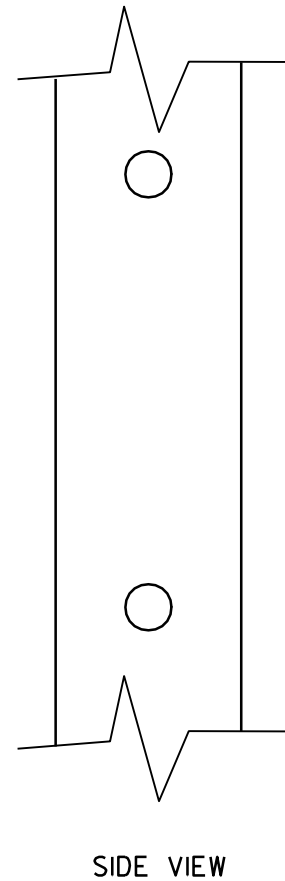
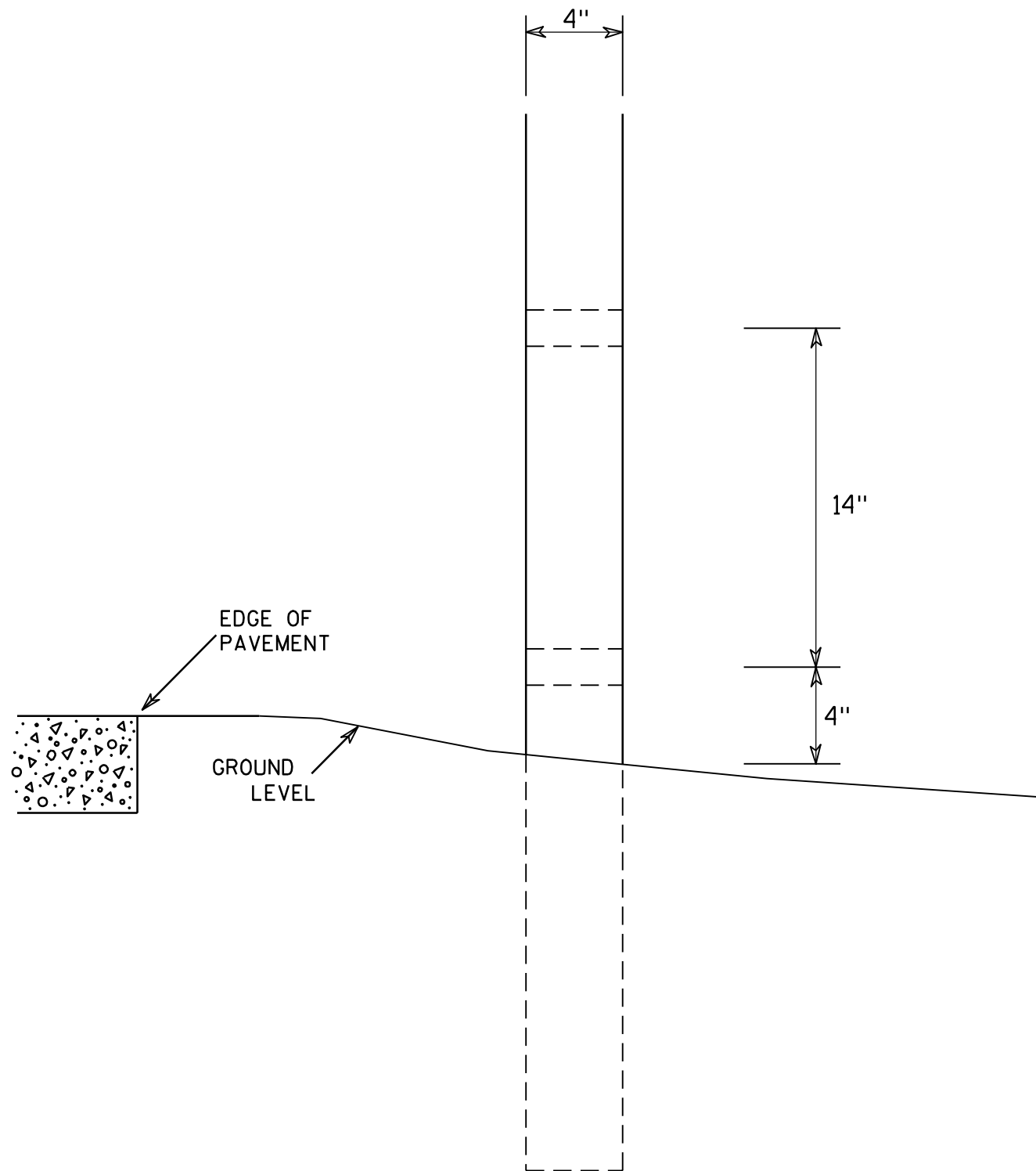

GENERAL NOTES

1. All 4 x 6 Wood Posts shall be modified by having two 1½" diameter holes drilled perpendicular to the roadway centerline.

7

7

4 X 6 WOOD POST MODIFICATIONS	
<i>WISCONSIN DEPT OF TRANSPORTATION</i>	
APPROVED	<i>Chester J Spang</i> for State Traffic Engineer
DATE <u>3/27/97</u>	PLATE NO. <u>A4-11.2</u>

NOTES

1. Sign is Type II - Type F Reflective - reference WIS DOT Standard Specification for HIGHWAY and STRUCTURE CONSTRUCTION latest edition.
2. Color:
Background - Orange
Message - Black
3. Message Series - C
4. Corners may be square or rounded when base material is plywood but borders shall be rounded as shown. When base material is metal, the corners and borders shall be rounded.

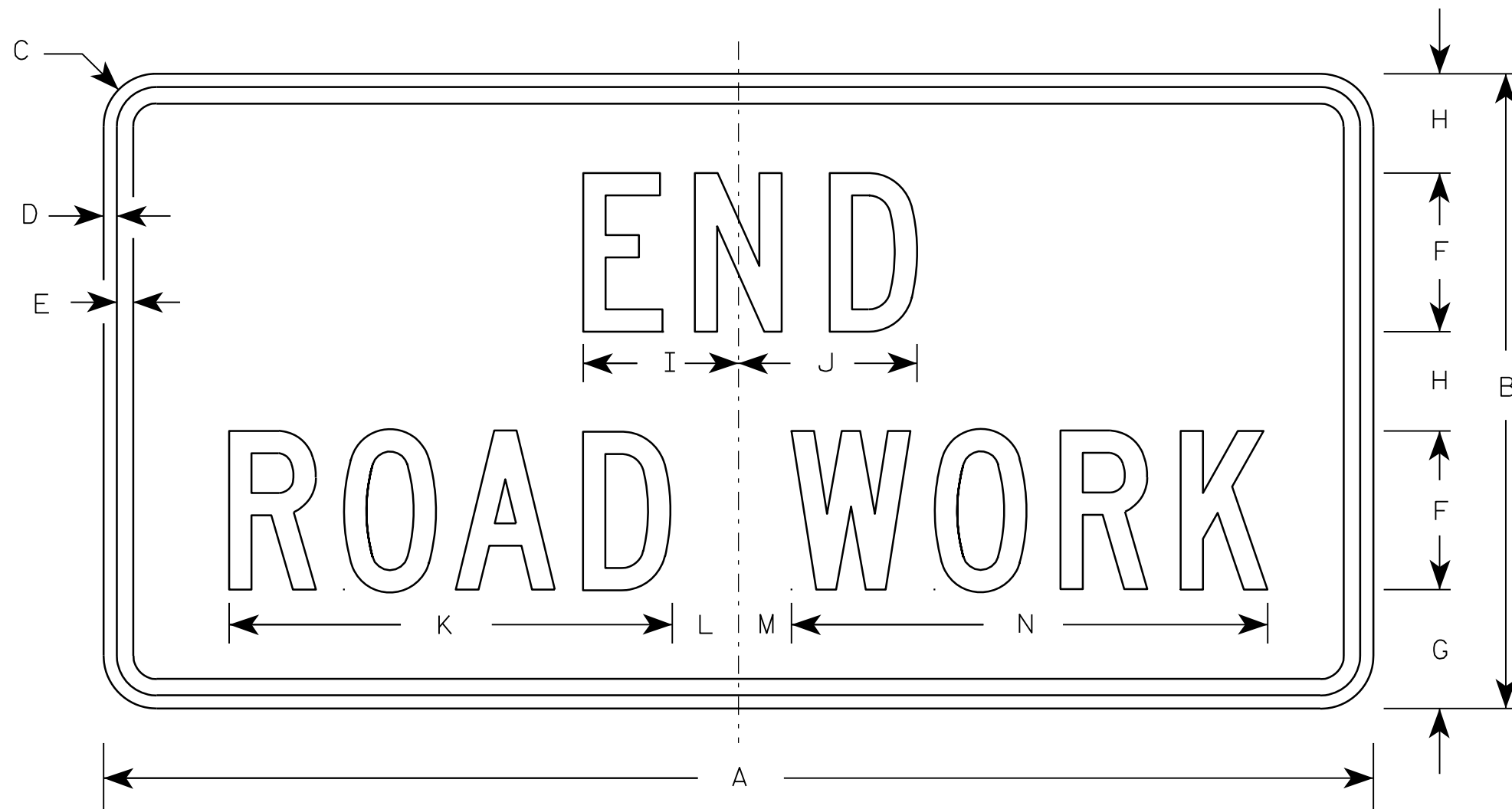

G20-2A

7

7

Metric equivalent for this sign is:

SIZE	
1	900 mm X 450 mm
2	1200 mm X 600 mm
3	1200 mm X 600 mm
4	1200 mm X 600 mm
5	1200 mm X 600 mm

SIZE	A	B	C	D	E	F	G	H	I	J	K	L	M	N	O	P	Q	R	S	T	U	V	W	X	Y	Z	Area sq. ft.	Area sq. m.
1	36	18	1 1/8	3/8	1/2	4	3 3/4	2 1/2	4 1/8	4 1/8	11 1/8	2	1	12 1/8													4.5	0.41
2	48	24	1 1/2	1/2	5/8	6	4 1/2	3 3/4	5 7/8	6 3/4	16 3/4	2 1/2	1 3/4	18 1/2													8.0	0.72
3	48	24	1 1/2	1/2	5/8	6	4 1/2	3 3/4	5 7/8	6 3/4	16 3/4	2 1/2	1 3/4	18 1/2													8.0	0.72
4	48	24	1 1/2	1/2	5/8	6	4 1/2	3 3/4	5 7/8	6 3/4	16 3/4	2 1/2	1 3/4	18 1/2													8.0	0.72
5	48	24	1 1/2	1/2	5/8	6	4 1/2	3 3/4	5 7/8	6 3/4	16 3/4	2 1/2	1 3/4	18 1/2													8.0	0.72

STANDARD SIGN G20-2A	
WISCONSIN DEPT OF TRANSPORTATION	
APPROVED	<i>Matthew R. Rauch</i> For State Traffic Engineer
DATE 9/30/09	PLATE NO. G20-2A.8

PROJECT NO:	HWY:	COUNTY:	SHEET NO:	E
-------------	------	---------	-----------	----------

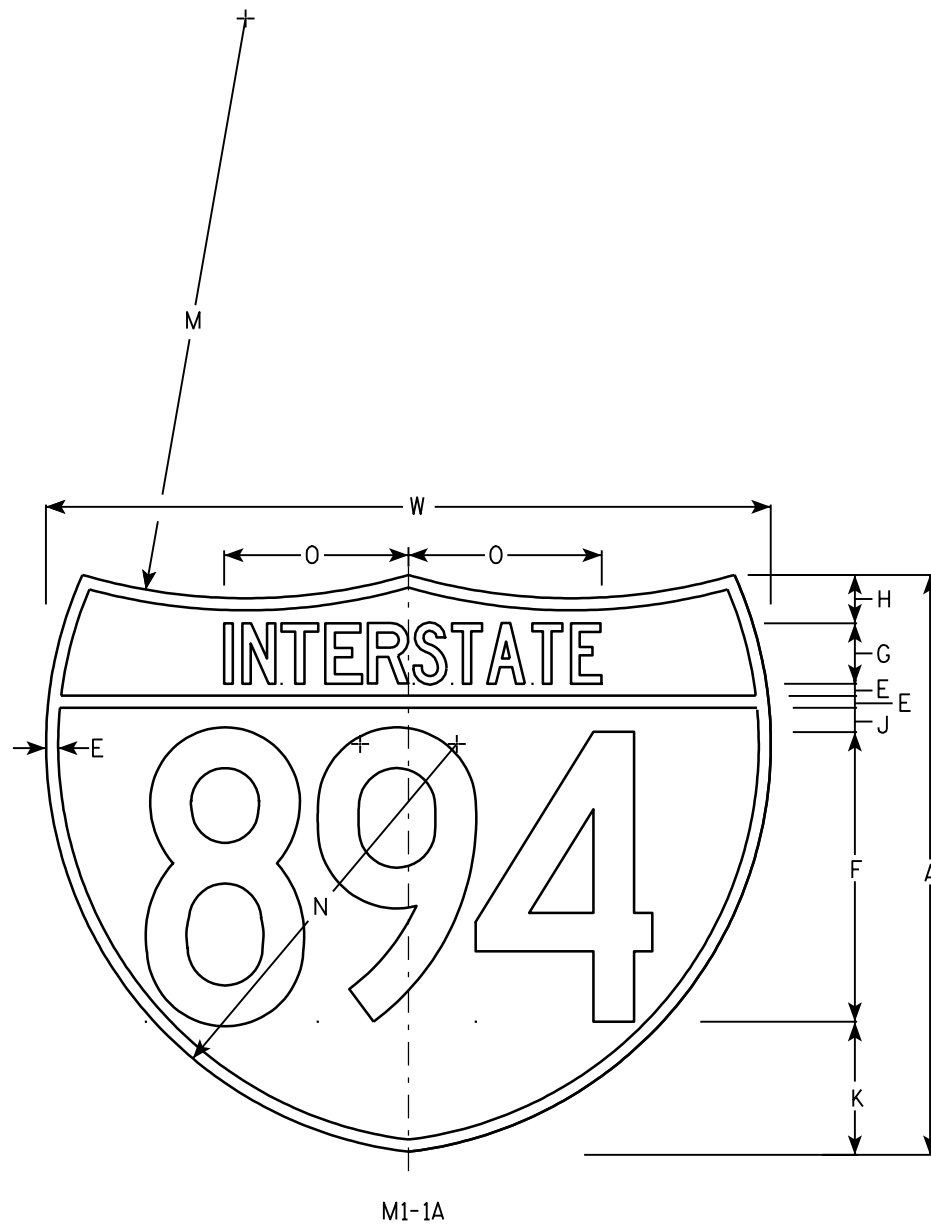
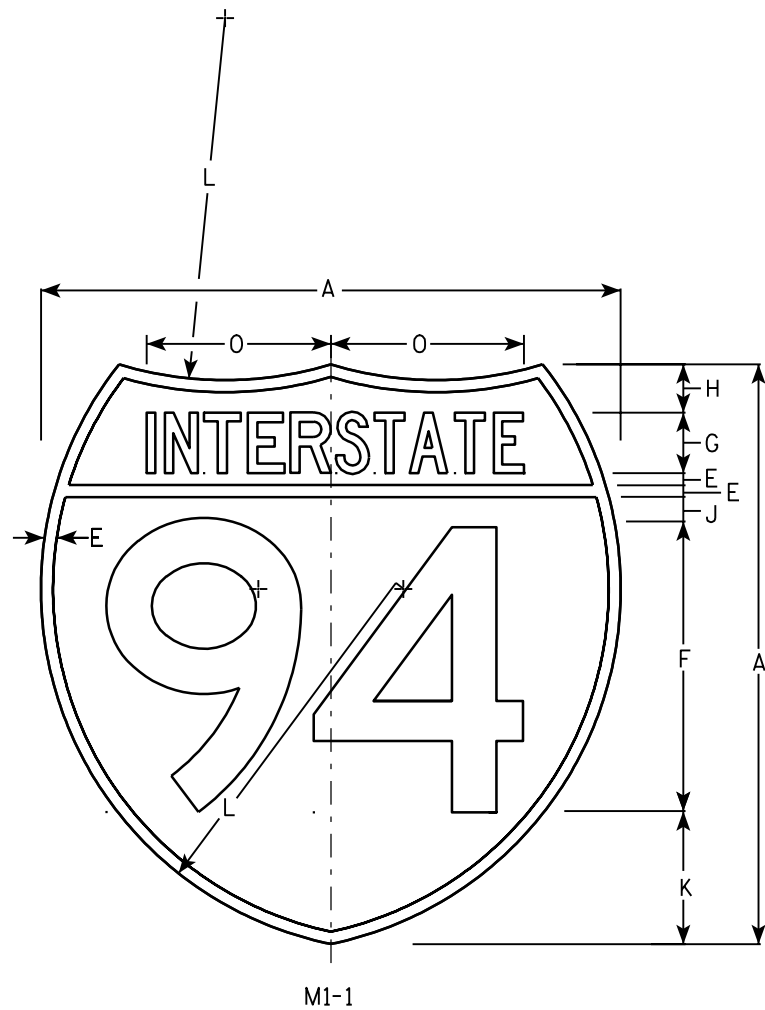

NOTES

1. Sign is Type II - See Note 6 - reference WIS DOT Standard Specification for HIGHWAY and STRUCTURE CONSTRUCTION latest edition.
2. Color:
Background - Top Red - Bottom Blue (See Note 6)
Message - White - See Note 6
3. Message Series - See note 5
4. Substitute appropriate numerals & adjust spacing as per plate A10-1.
5. M1-1 - Numerals - D
Interstate - C
M1-1A - All copy - C
6. Permanent Signs
Message - Type H Reflective
Detour or other temporary signs
Background - Reflective
Message - Reflective

Metric equivalent for these signs are:

SIZE	M1-1	SIZE	M1-1A
1			
2	600 mm X 600 mm	2	600 mm X 750 mm
3	900 mm X 900 mm	3	900 mm X 1125 mm
4	900 mm X 900 mm	4	900 mm X 1125 mm
5	900 mm X 900 mm	5	900 mm X 1125 mm

SIZE	A	B	C	D	E	F	G	H	I	J	K	L	M	N	O	P	Q	R	S	T	U	V	W	X	Y	M1-1 Area sq. ft.	M1-1A Area sq. ft.	M1-1 Area m ²	M1-1A Area m ²
1																													
2	24				1/2	12	2 1/2	2		1	5 1/2	15	24	17	7 7/8								30			3.13	3.91	.36	.46
3	36				3/4	18	3 3/4	3		1 1/2	8 1/4	22 1/2	36	25 1/2	11 3/4								45			7.03	8.79	.81	1.05
4	36				3/4	18	3 3/4	3		1 1/2	8 1/4	22 1/2	36	25 1/2	11 3/4								45			7.03	8.79	.81	1.05
5	36				3/4	18	3 3/4	3		1 1/2	8 1/4	22 1/2	36	25 1/2	11 3/4								45			7.03	8.79	.81	1.05

INTERSTATE ROUTE MARKER
M1-1 FOR ASSEMBLIES

WISCONSIN DEPT OF TRANSPORTATION

APPROVED *Matthew R Rauch*
for State Traffic Engineer

DATE 08/23/05 PLATE NO. M1-1.8

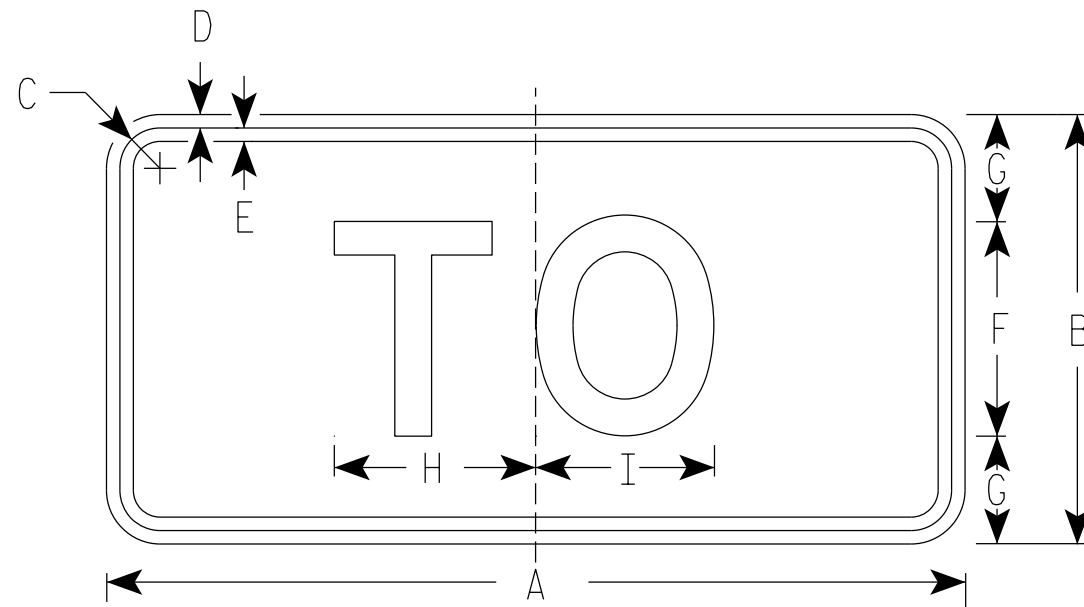

M4-5
MM4-5
MP4-5
M04-5

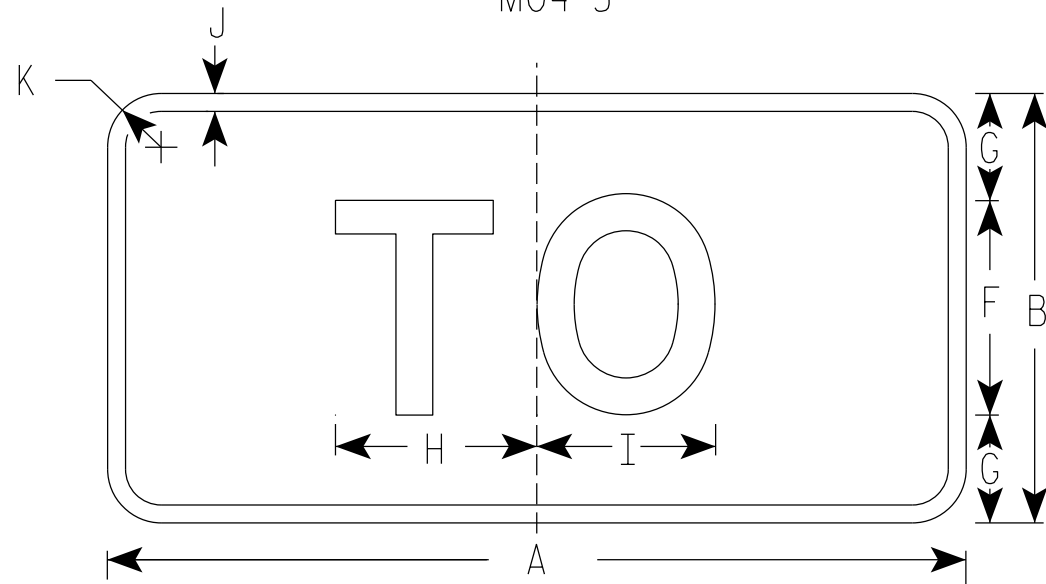

MB4-5
MK4-5
MN4-5

NOTES

1. Sign is Type II - Type H Reflective
2. Color:
Background - See note 5
Message - See note 5
3. Message Series - E
4. Corners may be square or rounded when base material is plywood but borders shall be rounded as shown. When base material is metal, the corners and borders shall be rounded.
5. M4-5 Background - White
Message - Black
MB4-5 Background - Blue
Message - White
MK4-5 Background - Green
Message - White
MM4-5 Background - White
Message - Green
MN4-5 Background - Brown
Message - White
MP4-5 Background - White
Message - Blue
M04-5 Background - Orange Type F Reflective
Message - Black

7

7

SIZE	A	B	C	D	E	F	G	H	I	J	K	L	M	N	O	P	Q	R	S	T	U	V	W	X	Y	Z	Area sq. ft.
1																											
2	24	12	1 1/8	3/8	3/8	6	3	5 3/8	5 1/4	1/2	1 1/2																2.00
3	36	18	1 3/8	3/8	1/2	9	4 1/2	8 1/4	8 3/8	1/2	1 1/2																4.5
4	36	18	1 3/8	3/8	1/2	9	4 1/2	8 1/4	8 3/8	1/2	1 1/2																4.5
5	36	18	1 3/8	3/8	1/2	9	4 1/2	8 1/4	8 3/8	1/2	1 1/2																4.5

STANDARD SIGN
M4-5

WISCONSIN DEPT OF TRANSPORTATION

APPROVED *Matthew R. Rauch*
State Traffic Engineer

DATE 03/7/19 PLATE NO. M4-5.9

PROJECT NO: _____ HWY: _____ COUNTY: _____ SHEET NO: **E**

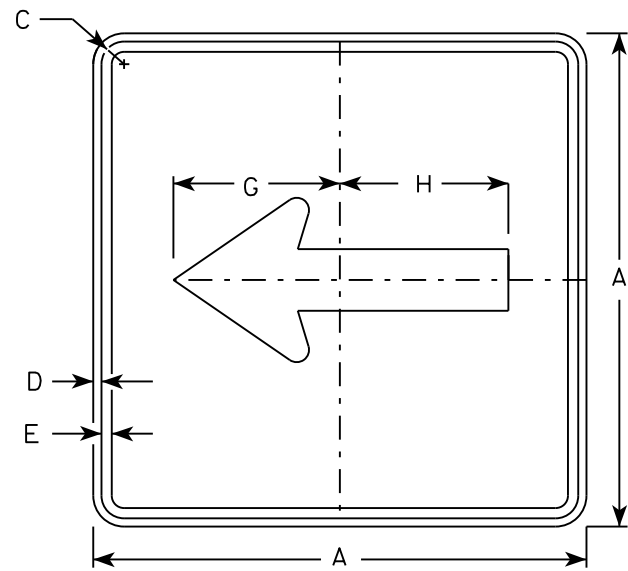

M6-1
MM6-1
M06-1
MP6-1

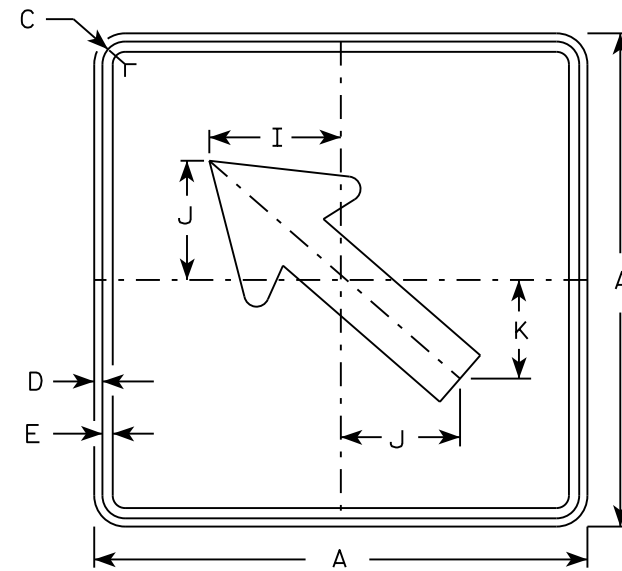

M6-2
MM6-2
M06-2
MP6-2

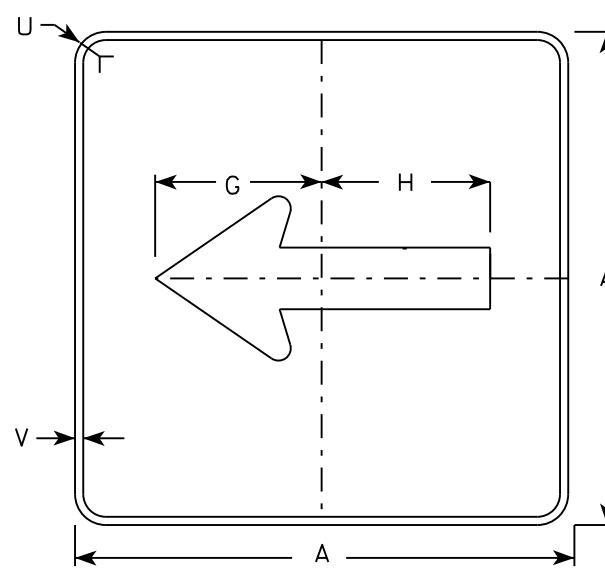

MB6-1
MK6-1
MN6-1
MR6-1

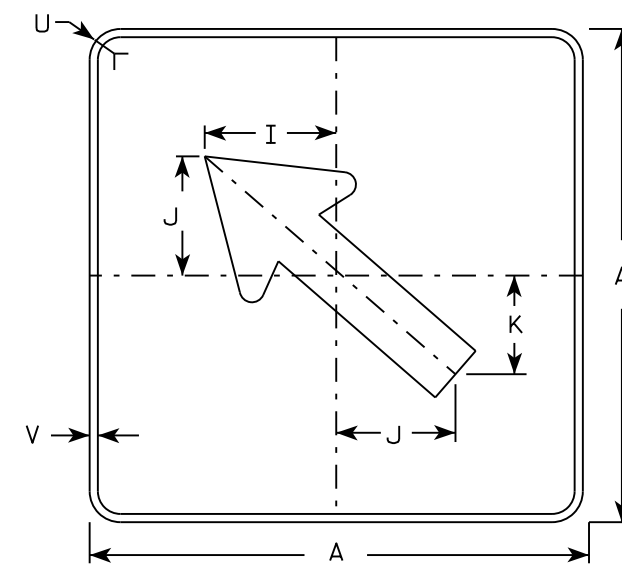

MB6-2
MK6-2
MN6-2
MR6-2

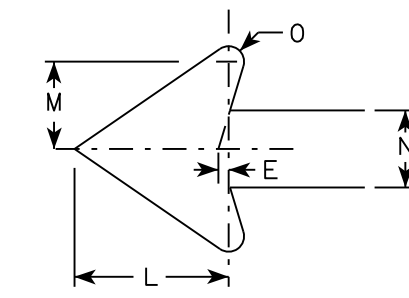

NOTES

- Signs are Type II - Type H except as Shown
- Color:
Background - See note 4
Message - See note 4
- Corners may be square or rounded when base material is plywood but borders shall be rounded as shown. When base material is metal, the corners and borders shall be rounded.
- M6-1 and M6-2 Background - White
Message - Black
MB6-1 and MB6-2 Background - Blue
Message - White
MK6-1 and MK6-2 Background - Green
Message - White
MM6-1 and MM6-2 Background - White
Message - Green
MN6-1 and MN6-2 Background - Brown
Message - White
M06-1 and M06-2 Background - Orange - Type F Reflective
Message - Black
MP6-1 and MP6-2 Background - White
Message - Blue
MR6-1 and MR6-2 Background - Brown
Message - Yellow

7

SIZE	A	B	C	D	E	F	G	H	I	J	K	L	M	N	O	P	Q	R	S	T	U	V	W	X	Y	Z	Area sq. ft.
1																											
2	21		1 1/8	3/8	3/8		7 1/2	7 1/8	5 5/8	5	4 1/4	5 1/4	3	2 5/8	1/2						1 1/2	1/2					3.06
3	30		1 3/8	1/2	5/8		10 3/4	10 1/4	8	7 1/4	6	7 1/2	4 1/4	3 3/4	3/4						1 7/8	1/2					6.25
4	30		1 3/8	1/2	5/8		10 3/4	10 1/4	8	7 1/4	6	7 1/2	4 1/4	3 3/4	3/4						1 7/8	1/2					6.25
5	30		1 3/8	1/2	5/8		10 3/4	10 1/4	8	7 1/4	6	7 1/2	4 1/4	3 3/4	3/4						1 7/8	1/2					6.25

STANDARD SIGN
M6-1 & M6-2
SERIES

WISCONSIN DEPT OF TRANSPORTATION

APPROVED *Matthew R. Rauch*
for State Traffic Engineer

DATE 10/15/15 PLATE NO. M6-1.15

NOTES

1. Sign is Type II - Type H Reflective
2. Color:
Background - See detail
Message - White
3. Message Series - D

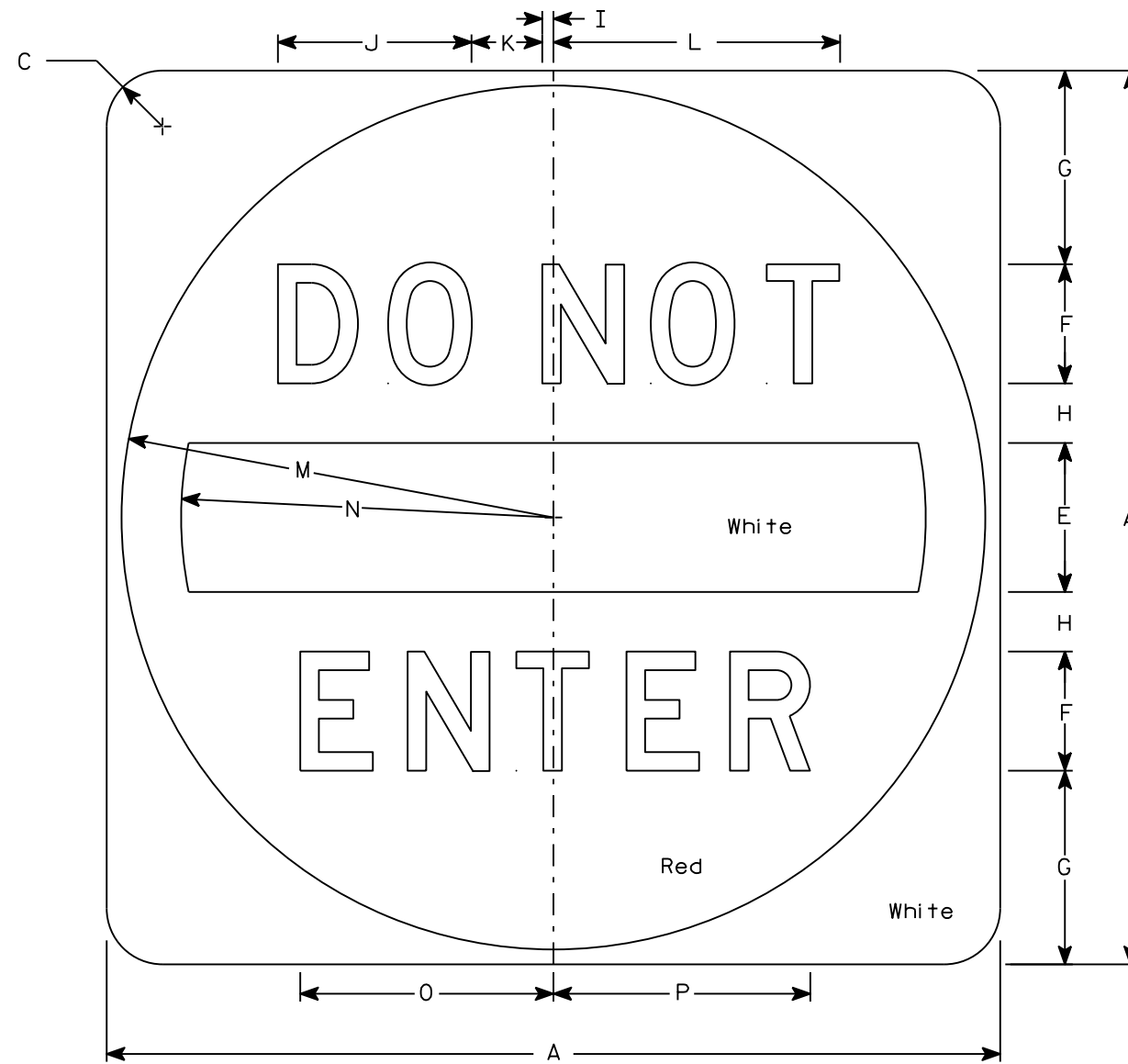

R5-1

7

7

SIZE	A	B	C	D	E	F	G	H	I	J	K	L	M	N	O	P	Q	R	S	T	U	V	W	X	Y	Z	Area sq. ft.
1																											
2S	30		1 7/8		5	4	6 1/2	2	3/8	6 1/2	2 3/8	9 5/8	14 1/2	12 1/2	8 1/2	8 5/8											6.25
2M	36		2 1/4		6	5	7 1/2	2 1/2	1/2	8 1/8	3	12 1/8	17 1/2	15	10 5/8	10 3/4											9.0
3	36		2 1/4		6	5	7 1/2	2 1/2	1/2	8 1/8	3	12 1/8	17 1/2	15	10 5/8	10 3/4											9.0
4	36		2 1/4		6	5	7 1/2	2 1/2	1/2	8 1/8	3	12 1/8	17 1/2	15	10 5/8	10 3/4											9.0
5	48		3		8	6	11	3	5/8	9 3/4	3 5/8	14 1/2	23 1/2	20	12 3/4	12 7/8											16.0

STANDARD SIGN
R5-1

WISCONSIN DEPT OF TRANSPORTATION

APPROVED *Matthew R. Rauch*
for State Traffic Engineer

DATE 3/15/18 PLATE NO. R5-1.16

PROJECT NO: _____ HWY: _____ COUNTY: _____ SHEET NO: **E**

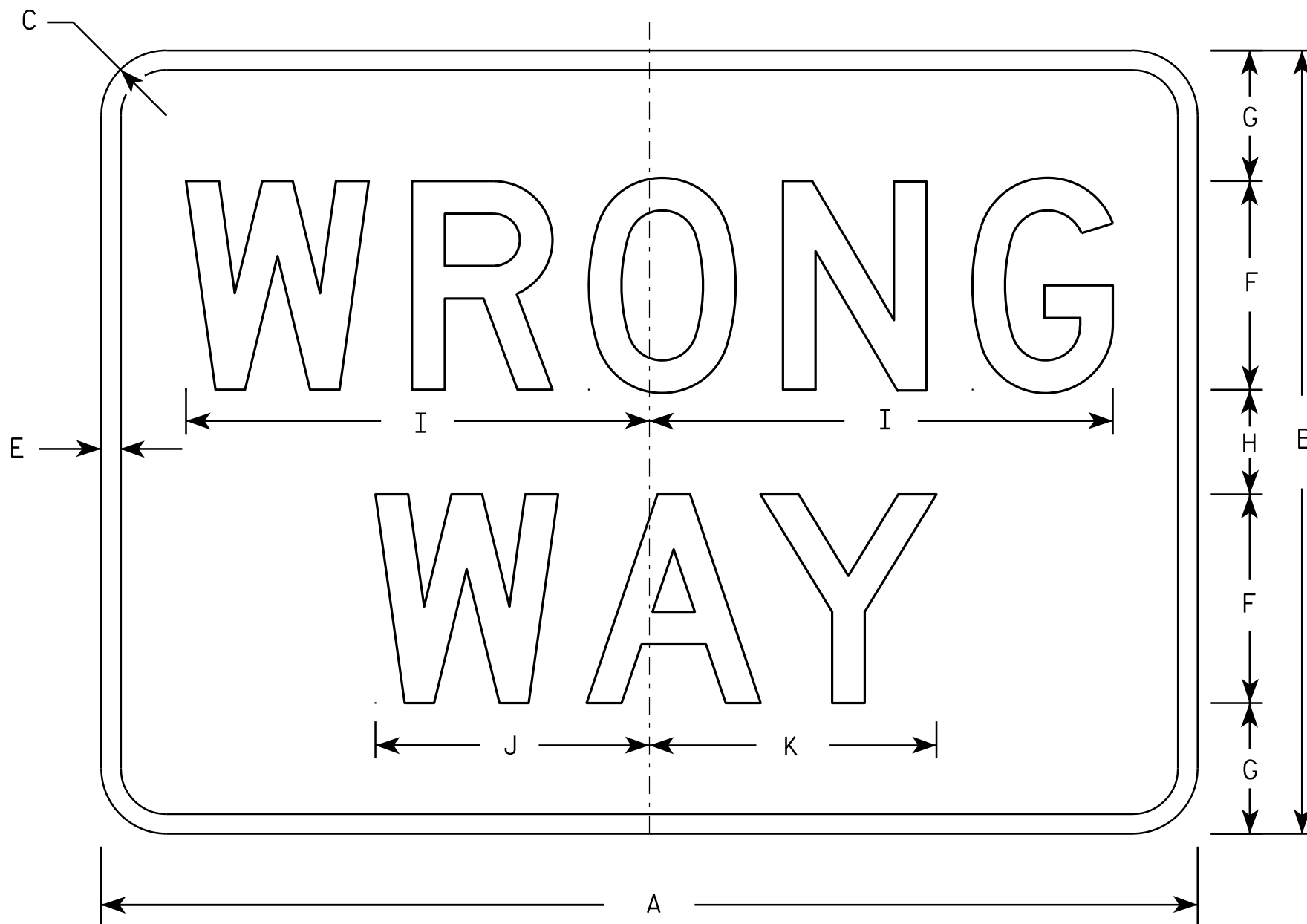

NOTES

1. Sign is Type II - Type H Reflective - reference WIS DOT Standard Specification for HIGHWAY and STRUCTURE CONSTRUCTION latest edition.
2. Color:
Background - Red
Message - White
3. Message Series - D
4. Corners may be square or rounded when base material is plywood but borders shall be rounded as shown. When base material is metal, the corners and borders shall be rounded.

7

7

R5-1A

SIZE	A	B	C	D	E	F	G	H	I	J	K	L	M	N	O	P	Q	R	S	T	U	V	W	X	Y	Z	Area sq. ft.
1	30	18	1 1/2		1/2	5	3	2	11	6 1/2	6 7/8																3.75
2S	36	24	2		5/8	6	4 1/2	3	13 1/4	7 7/8	8 1/4																6.00
2M	42	30	2 1/2		3/4	8	5	4	17 3/4	10 1/2	11																8.75
3	42	30	2 1/2		3/4	8	5	4	17 3/4	10 1/2	11																8.75
4	42	30	2 1/2		3/4	8	5	4	17 3/4	10 1/2	11																8.75
5	42	30	2 1/2		3/4	8	5	4	17 3/4	10 1/2	11																8.75

STANDARD SIGN
R5-1A

WISCONSIN DEPT OF TRANSPORTATION

APPROVED *Matthew R. Rauch*
for State Traffic Engineer

DATE 12/17/10 PLATE NO. R5-1A.2

PROJECT NO: _____ HWY: _____ COUNTY: _____ SHEET NO: _____ E



R10-70

NOTES

1. Sign is Type II - Type H Reflective - reference WIS DOT Standard Specification for HIGHWAY and STRUCTURE CONSTRUCTION latest edition.
2. Color:
Background - White
Message - Black
3. Message Series - D
4. Corners may be square or rounded when base material is plywood but borders shall be rounded as shown. When base material is metal, the corners and borders shall be rounded.



R10-70L

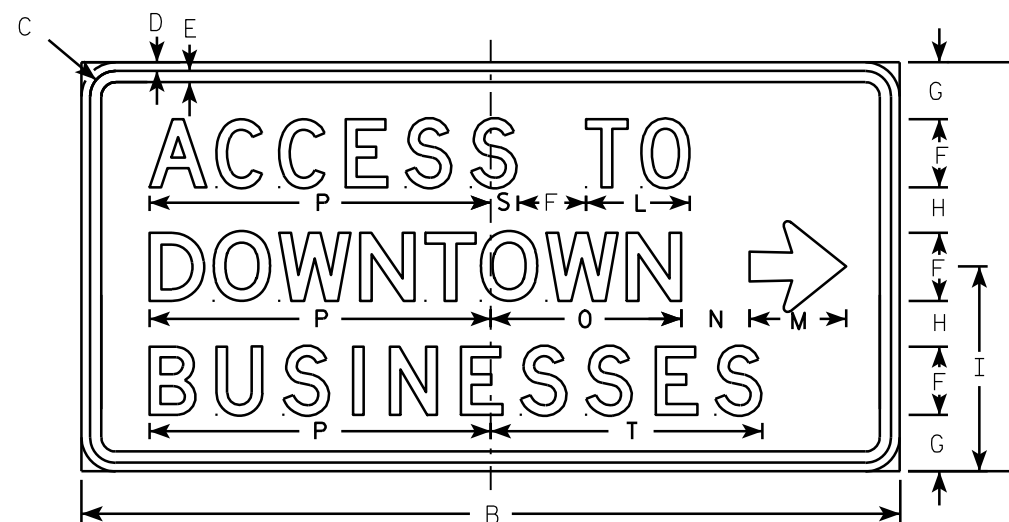

R10-70R

7

7

SIZE	A	B	C	D	E	F	G	H	I	J	K	L	M	N	O	P	Q	R	S	T	U	V	W	X	Y	Z	R10-70L&R Area sq. ft.	R10-70 Area sq. ft.
1																												
2S	36	72	2 1/4	3/4	1	6	5	4	18	17 1/2	14 1/8	9 1/8	8 1/2	6	16 3/4	30	23 3/4	66	2 3/8	23 7/8	23 7/8	8 3/4	23 1/4	23 1/2	26 7/8	27	18.0	16.5
2M	36	72	2 1/4	3/4	1	6	5	4	18	17 1/2	14 1/8	9 1/8	8 1/2	6	16 3/4	30	23 3/4	66	2 3/8	23 7/8	23 7/8	8 3/4	23 1/4	23 1/2	26 7/8	27	18.0	16.5
3																												
4																												
5																												

STANDARD SIGN
R10-70

WISCONSIN DEPT OF TRANSPORTATION

APPROVED *Matthew R. Rauch*
for State Traffic Engineer

DATE 4/4/11 PLATE NO. R10-70.2

PROJECT NO: _____ SHEET NO: **E**

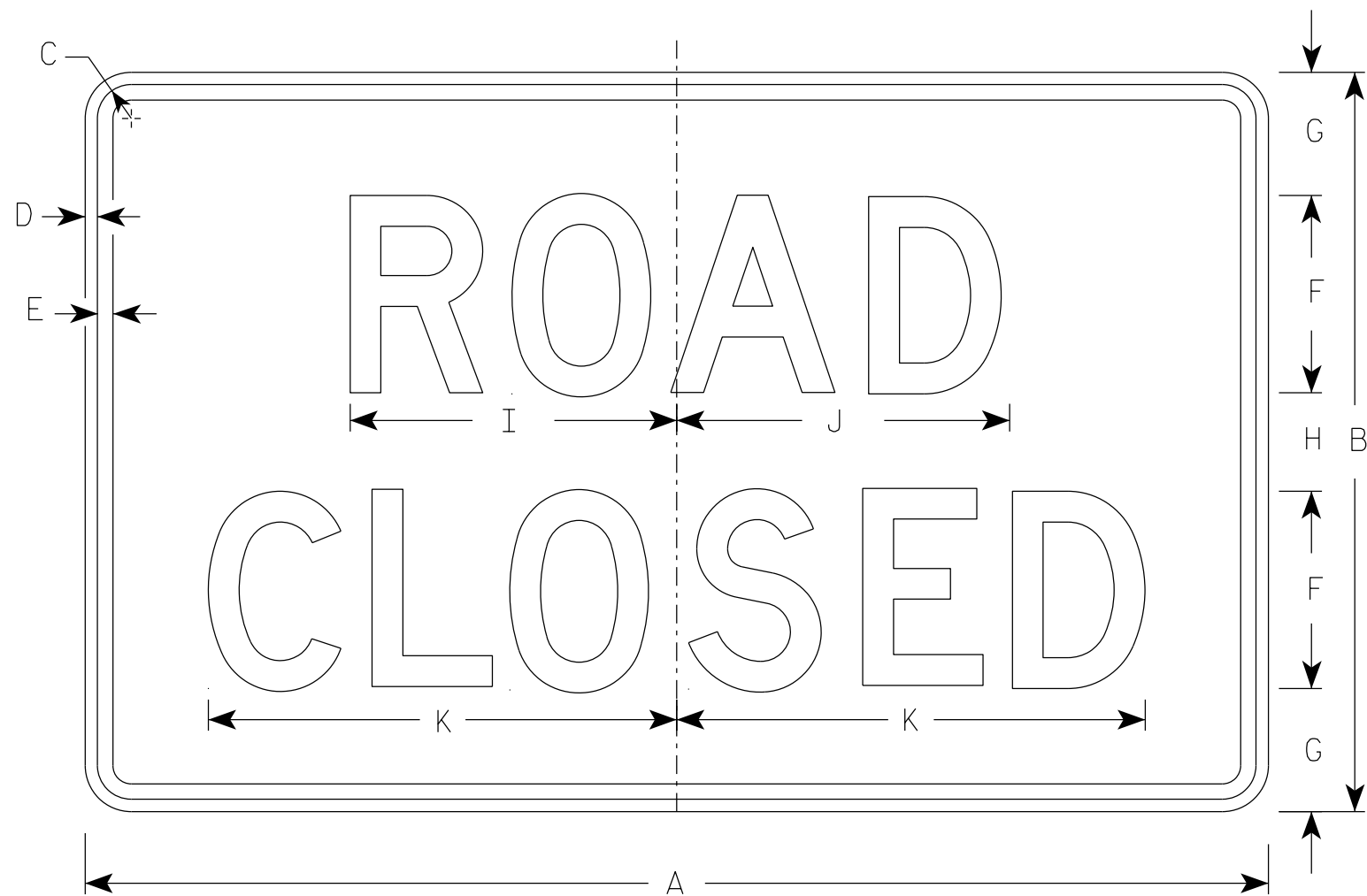

R11-2



R11-2R

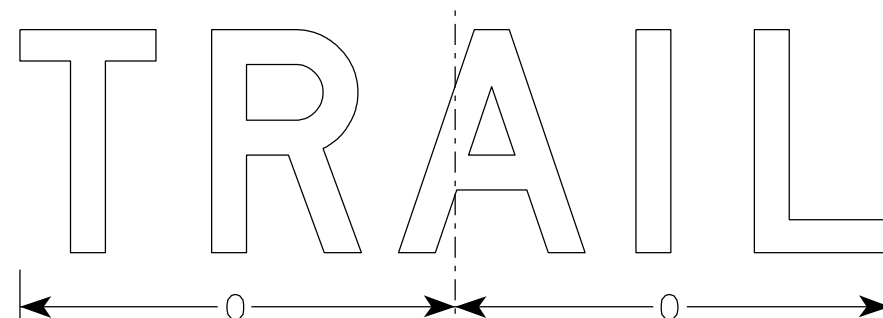

R11-2T

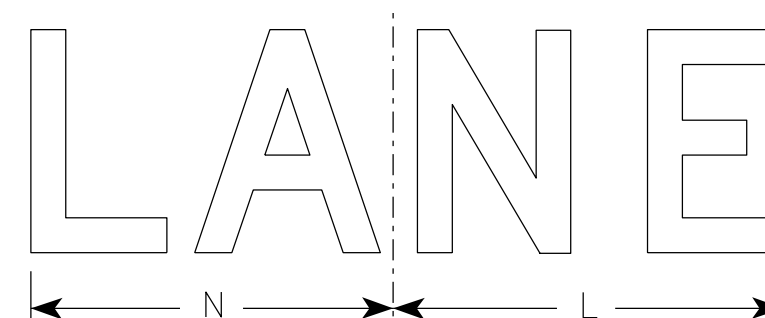

R11-2L

NOTES

1. Sign is Type II - Type H Reflective
2. Color:
Background - White
Message - Black
3. Message Series - D
4. Corners may be square or rounded when base material is plywood but borders shall be rounded as shown. When base material is metal, the corners and borders shall be rounded.
5. Modify the message as required.

7

7

SIZE	A	B	C	D	E	F	G	H	I	J	K	L	M	N	O	P	Q	R	S	T	U	V	W	X	Y	Z	Area sq. ft.
1																											
2S	48	30	1 3/8	1/2	5/8	8	5	4	13 1/4	13 1/2	19	14	15	13	15 5/8												10.0
2M	48	30	1 3/8	1/2	5/8	8	5	4	13 1/4	13 1/2	19	14	15	13	15 5/8												10.0
3	48	30	1 3/8	1/2	5/8	8	5	4	13 1/4	13 1/2	19	14	15	13	15 5/8												10.0
4	48	30	1 3/8	1/2	5/8	8	5	4	13 1/4	13 1/2	19	14	15	13	15 5/8												10.0
5	48	30	1 3/8	1/2	5/8	8	5	4	13 1/4	13 1/2	19	14	15	13	15 5/8												10.0

STANDARD SIGN
R11-2

WISCONSIN DEPT OF TRANSPORTATION

APPROVED *Matthew R. Rauch*
For State Traffic Engineer

DATE 3/29/2021 PLATE NO. R11-2.11

PROJECT NO: _____ HWY: _____ COUNTY: _____ SHEET NO: **E**

NOTES

1. Sign is Type II - Type F Reflective
2. Color:
Background - Orange
Message - Black
3. Message Series - C
4. Corners may be square or rounded when base material is plywood but borders shall be rounded as shown. When base material is metal, the corners and borders shall be rounded.

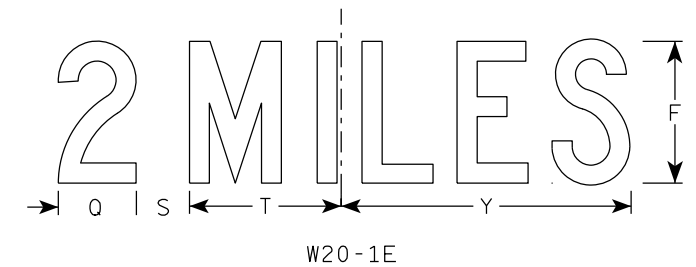
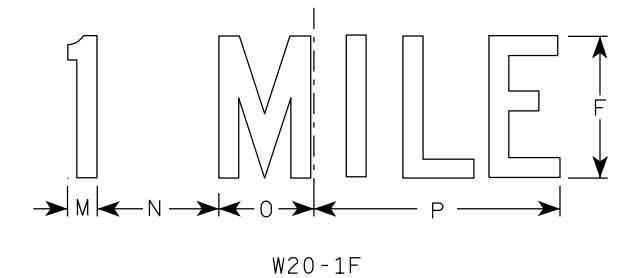
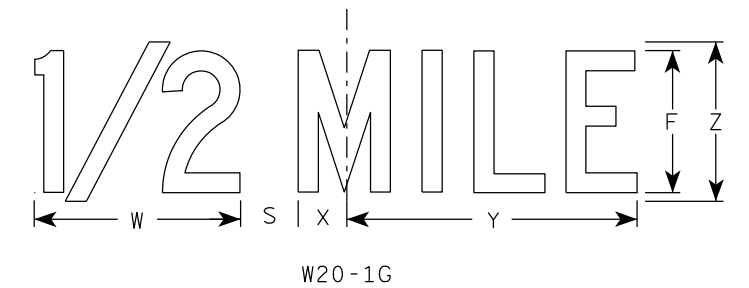
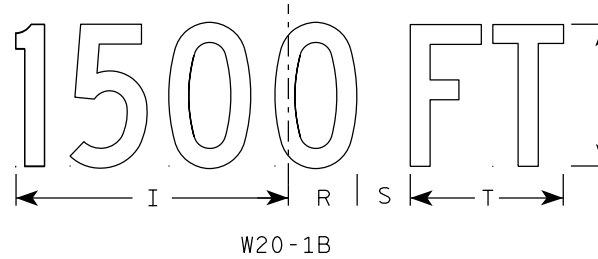
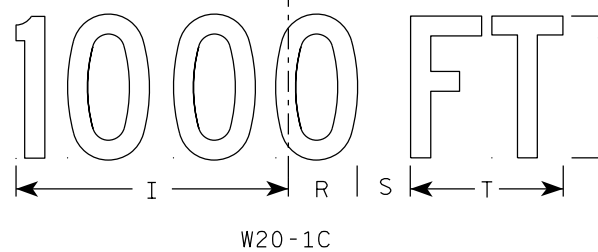
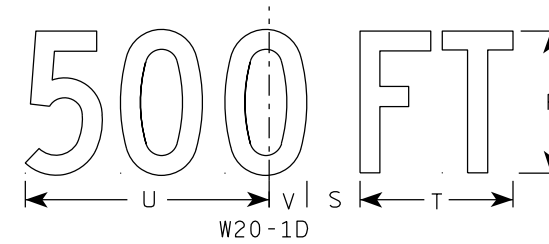
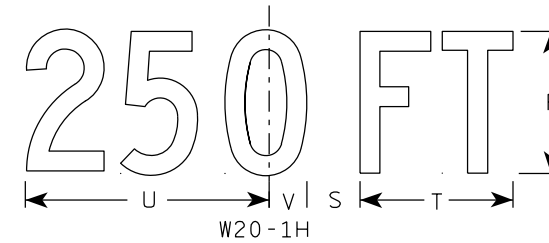
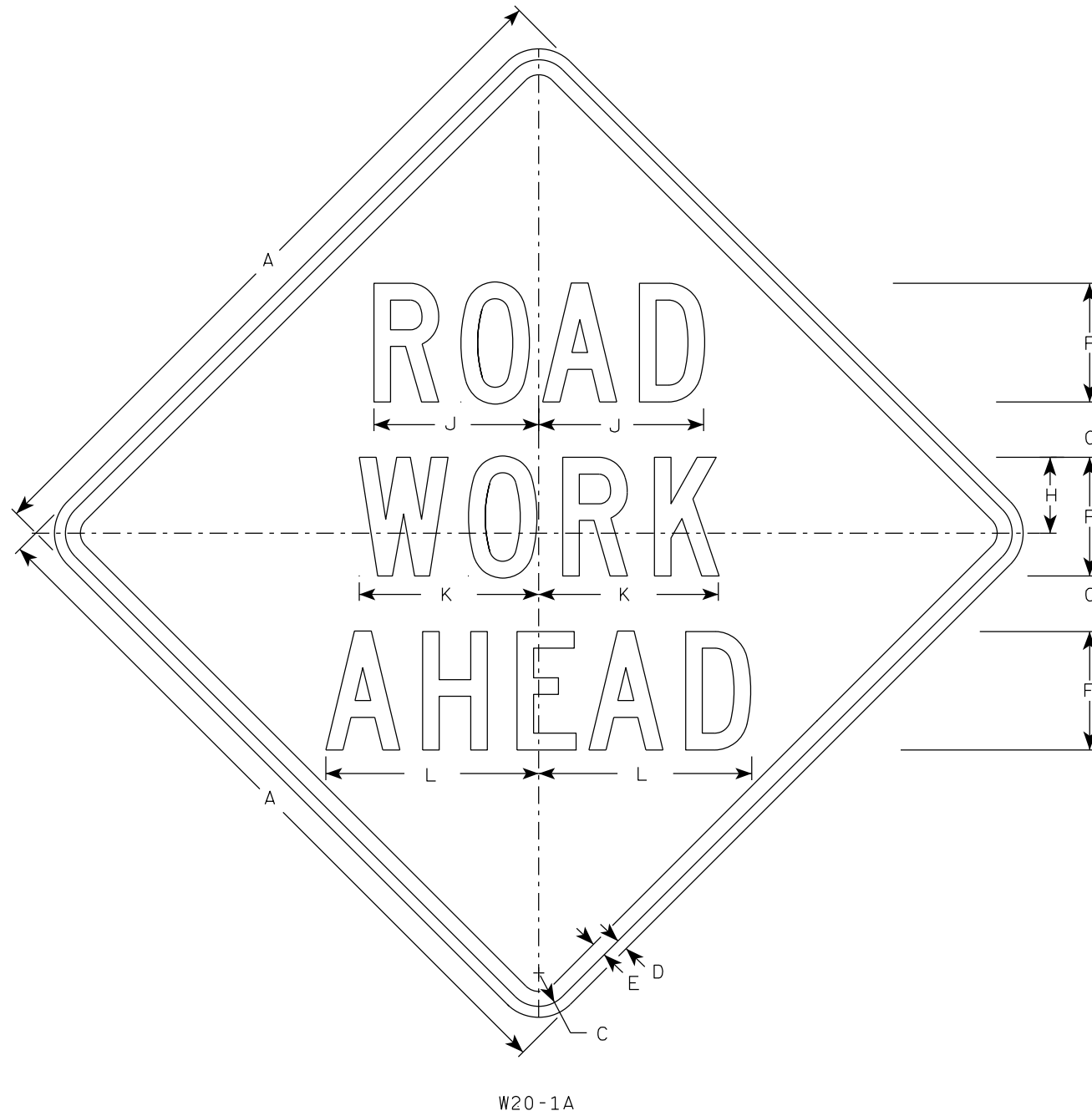

SIZE	A	B	C	D	E	F	G	H	I	J	K	L	M	N	O	P	Q	R	S	T	U	V	W	X	Y	Z	Area sq. ft.
1	36		1 5/8	5/8	3/4	5	2 5/8	3 1/4	10 1/8	7	7 5/8	8 7/8	1 1/8	4 1/2	3 1/2	9	3 1/4	2 1/2	2 1/4	5 5/8	9	1 3/8	8	1 3/4	10 3/4	6	9.0
2S	48		2 1/4	3/4	1	8	3 3/4	5 1/8	15 3/8	11 1/8	12 1/8	14 3/8	1 5/8	6 7/8	5 3/8	13 7/8	4 3/8	3 7/8	3	8 5/8	13 3/4	2 1/8	11 7/8	2 3/4	16 3/8	9	16.0
2M	48		2 1/4	3/4	1	8	3 3/4	5 1/8	15 3/8	11 1/8	12 1/8	14 3/8	1 5/8	6 7/8	5 3/8	13 7/8	4 3/8	3 7/8	3	8 5/8	13 3/4	2 1/8	11 7/8	2 3/4	16 3/8	9	16.0
3	48		2 1/4	3/4	1	8	3 3/4	5 1/8	15 3/8	11 1/8	12 1/8	14 3/8	1 5/8	6 7/8	5 3/8	13 7/8	4 3/8	3 7/8	3	8 5/8	13 3/4	2 1/8	11 7/8	2 3/4	16 3/8	9	16.0
4	48		2 1/4	3/4	1	8	3 3/4	5 1/8	15 3/8	11 1/8	12 1/8	14 3/8	1 5/8	6 7/8	5 3/8	13 7/8	4 3/8	3 7/8	3	8 5/8	13 3/4	2 1/8	11 7/8	2 3/4	16 3/8	9	16.0
5	48		2 1/4	3/4	1	8	3 3/4	5 1/8	15 3/8	11 1/8	12 1/8	14 3/8	1 5/8	6 7/8	5 3/8	13 7/8	4 3/8	3 7/8	3	8 5/8	13 3/4	2 1/8	11 7/8	2 3/4	16 3/8	9	16.0

STANDARD SIGN
W20-1A, B, C, D, E, F, G & H

WISCONSIN DEPT OF TRANSPORTATION

APPROVED *Matthew R. Rauch*
For State Traffic Engineer

DATE 3/25/2020 PLATE NO. W20-1.11

NOTES

1. Sign is Type II - Type H Reflective
2. Color:
Background - White
Message - Black
3. Message Series - D

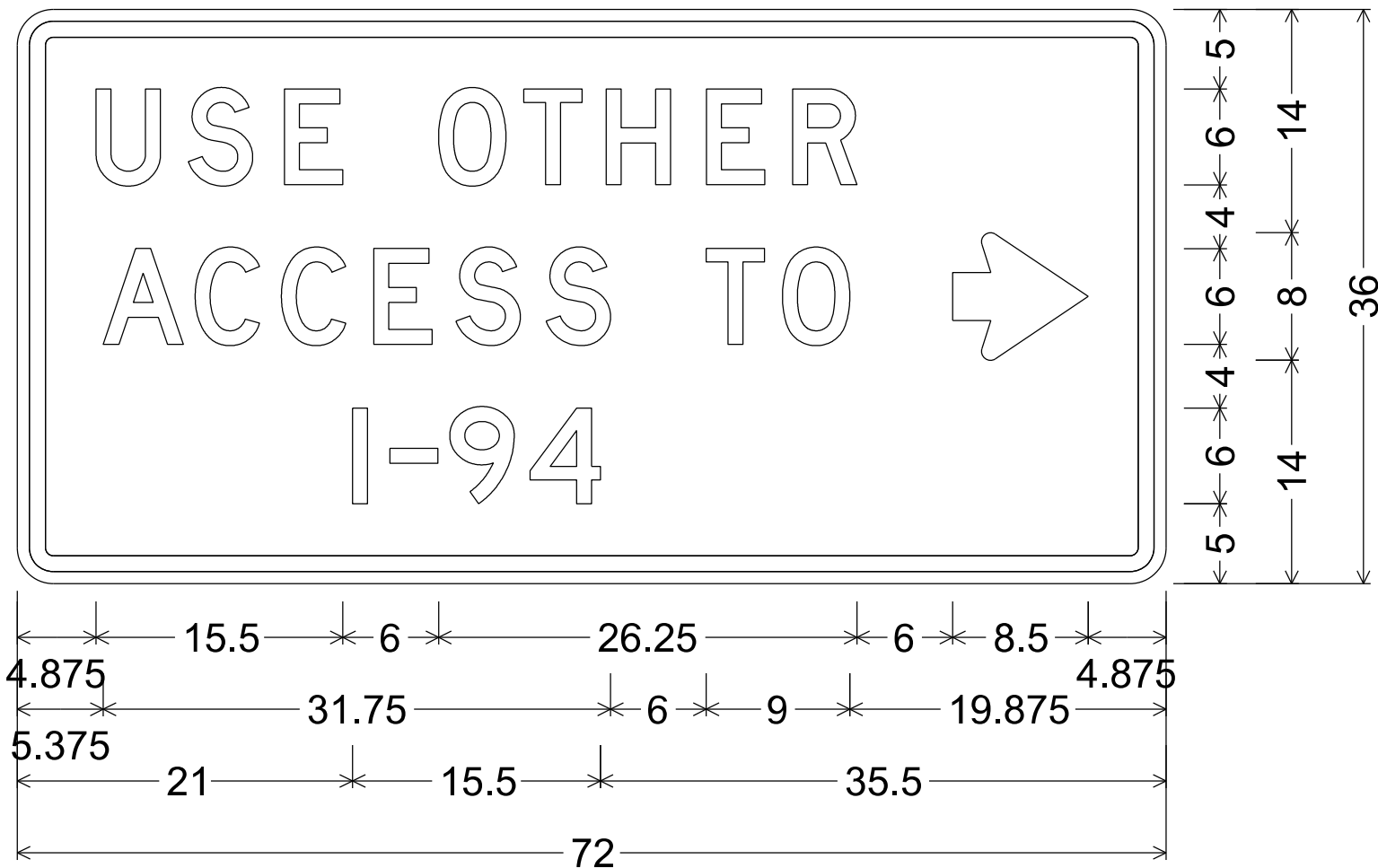

R10-70R; 2.250" Radius, 1.000" Border, 0.750" Indent

7

7

NOTES

1. Fixed Message Sign Type II - Type H Reflective
2. Color:
 Background - White
 Message - Black
3. Message Series - D

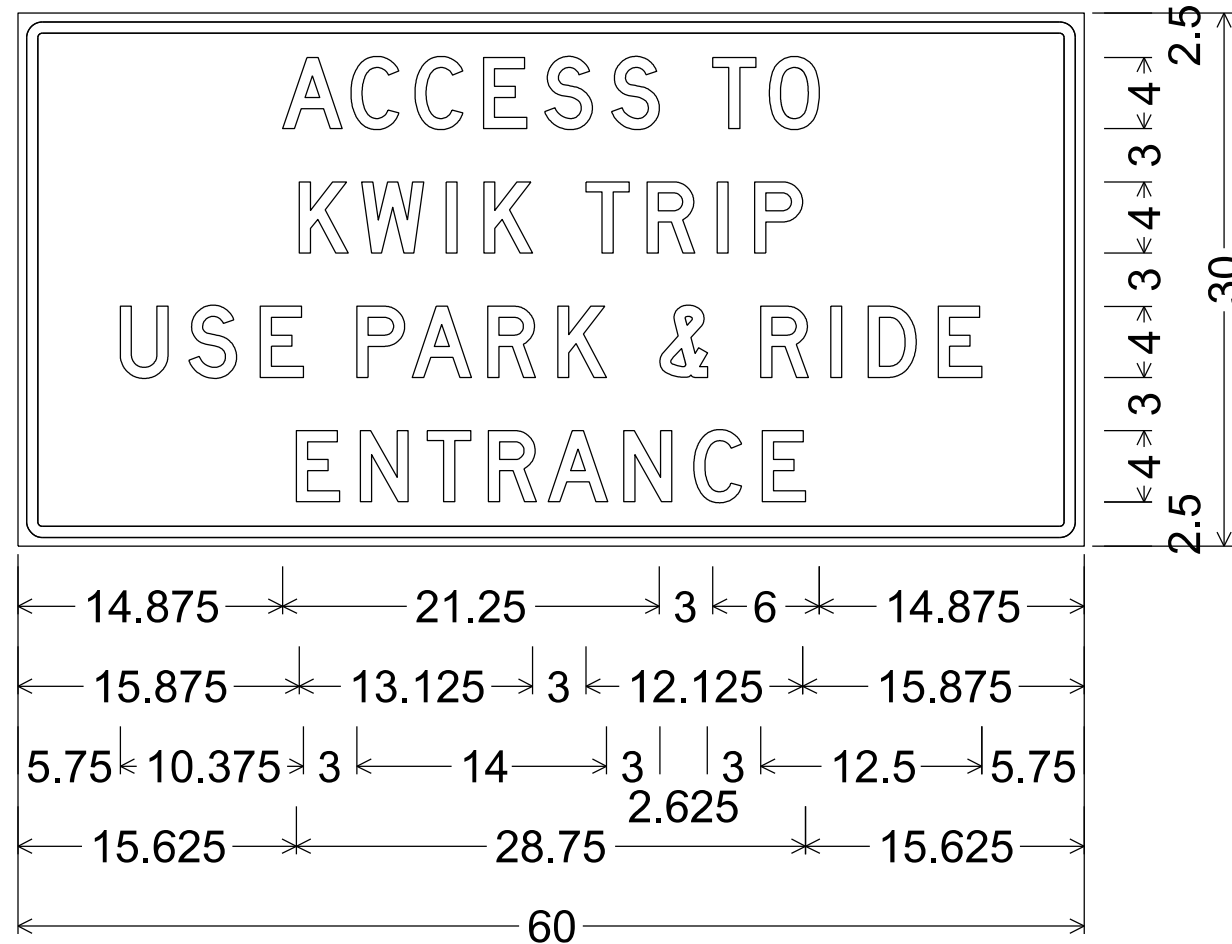

1.375" Radius, 0.625" Border, 0.500" Indent

7

7

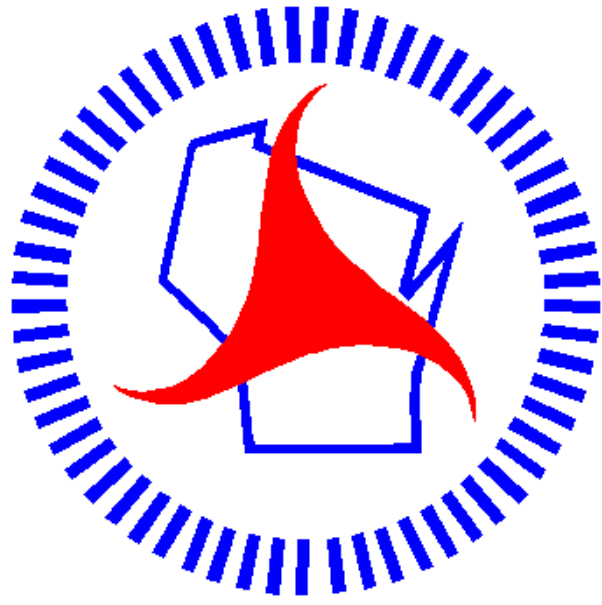

Wisconsin Department of Transportation

Dedicated people creating transportation solutions through innovation and exceptional service.

<http://www.dot.wisconsin.gov>