

# HIGHWAY WORK PROPOSAL

Wisconsin Department of Transportation  
DT1502 01/2020 s.66.0901(7) Wis. Stats

Proposal Number: **007**

<u>COUNTY</u>	<u>STATE PROJECT</u>	<u>FEDERAL</u>	<u>PROJECT DESCRIPTION</u>	<u>HIGHWAY</u>
Waukesha	1060-10-71	N/A	IH 94 East West Freeway; CTH T and CTH Jj (B-67-240,245)	IH 094
Waukesha	1060-47-70	N/A	IH 94 East West Freeway; STH 83 to STH 16	IH 094
Waukesha	1330-47-71	N/A	C Delafield, State Road 83; Nagawaukee Park and Ride Lot	OFF SYS
Waukesha	2788-03-70	N/A	C Waukesha Meadowbrook Road; Rolling Ridge Dr to IH 94 EB Ramps	STH 318

**ADDENDUM  
REQUIRED  
ATTACHED AT BACK**

This proposal, submitted by the undersigned bidder to the Wisconsin Department of Transportation, is in accordance with the advertised request for proposals. The bidder is to furnish and deliver all materials, and to perform all work for the improvement of the designated project in the time specified, in accordance with the appended Proposal Requirements and Conditions.

Proposal Guaranty Required: \$700,000.00 Payable to: Wisconsin Department of Transportation	Attach Proposal Guaranty on back of this PAGE.
Bid Submittal Date: April 9, 2024 Time (Local Time): 11:00 am	Firm Name, Address, City, State, Zip Code  <b>SAMPLE NOT FOR BIDDING PURPOSES</b>
Contract Completion Time May 22, 2025	
Assigned Disadvantaged Business Enterprise Goal <span style="float: right;">0%</span>	This contract is exempt from federal oversight.

This certifies that the undersigned bidder, duly sworn, is an authorized representative of the firm named above; that the bidder has examined and carefully prepared the bid from the plans, Highway Work Proposal, and all addenda, and has checked the same in detail before submitting this proposal or bid; and that the bidder or agents, officer, or employees have not, either directly or indirectly, entered into any agreement, participated in any collusion, or otherwise taken any action in restraint of free competitive bidding in connection with this proposal bid.

**Do not sign, notarize, or submit this Highway Work Proposal when submitting an electronic bid on the Internet.**

Subscribed and sworn to before me this date \_\_\_\_\_

\_\_\_\_\_  
(Signature, Notary Public, State of Wisconsin)

\_\_\_\_\_  
(Bidder Signature)

\_\_\_\_\_  
(Print or Type Name, Notary Public, State Wisconsin)

\_\_\_\_\_  
(Print or Type Bidder Name)

\_\_\_\_\_  
(Date Commission Expires)

\_\_\_\_\_  
(Bidder Title)

Notary Seal

<b>Type of Work:</b>	<b>For Department Use Only</b>
Excavation, Base, HMA Pavement, Concrete Pavement, Curb and Gutter, Culvert Pipe, Storm Sewer, Guardrail, Signs, Pavement Marking, Bridge Deck Sealing, Bridge Rehabilitation, Sidewalk, Traffic Signals, Street Lighting, FTMS.	
Notice of Award Dated	Date Guaranty Returned

**PLEASE ATTACH  
PROPOSAL GUARANTY HERE**

## PROPOSAL REQUIREMENTS AND CONDITIONS

The bidder, signing and submitting this proposal, agrees and declares as a condition thereof, to be bound by the following conditions and requirements.

If the bidder has a corporate relationship with the proposal design engineering company, the bidder declares that it did not obtain any facts, data, or other information related to this proposal from the design engineering company that was not available to all bidders.

The bidder declares that they have carefully examined the site of, and the proposal, plans, specifications and contract forms for the work contemplated, and it is assumed that the bidder has investigated and is satisfied as to the conditions to be encountered, as to the character, quality, and quantities of work to be performed and materials to be furnished, and as to the requirements of the specifications, special provisions and contract. It is mutually agreed that submission of a proposal shall be considered conclusive evidence that the bidder has made such examination.

The bidder submits herewith a proposal guaranty in proper form and amount payable to the party as designated in the advertisement inviting proposals, to be retained by and become the property of the owner of the work in the event the undersigned shall fail to execute the contract and contract bond and return the same to the office of the engineer within fourteen (14) days after having been notified in writing to do so; otherwise to be returned.

The bidder declares that they understand that the estimate of quantities in the attached schedule is approximate only and that the attached quantities may be greater or less in accordance with the specifications.

The bidder agrees to perform the said work, for and in consideration of the payment of the amount becoming due on account of work performed, according to the unit prices bid in the following schedule, and to accept such amounts in full payment of said work.

The bidder declares that all of the said work will be performed at their own proper cost and expense, that they will furnish all necessary materials, labor, tools, machinery, apparatus, and other means of construction in the manner provided in the applicable specifications and the approved plans for the work together with all standard and special designs that may be designed on such plans, and the special provisions in the contract of which this proposal will become a part, if and when accepted. The bidder further agrees that the applicable specifications and all plans and working drawings are made a part hereof, as fully and completely as if attached hereto.

The bidder, if awarded the contract, agrees to begin the work not later than ten (10) days after the date of written notification from the engineer to do so, unless otherwise stipulated in the special provisions.

The bidder declares that if they are awarded the contract, they will execute the contract agreement and begin and complete the work within the time named herein, and they will file a good and sufficient surety bond for the amount of the contract for performance and also for the full amount of the contract for payment.

The bidder, if awarded the contract, shall pay all claims as required by Section 779.14, Statutes of Wisconsin, and shall be subject to and discharge all liabilities for injuries pursuant to Chapter 102 of the Statutes of Wisconsin, and all acts amendatory thereto. They shall further be responsible for any damages to property or injury to persons occurring through their own negligence or that of their employees or agents, incident to the performance of work under this contract, pursuant to the Standard Specifications for Road and Bridge Construction applicable to this contract.

In connection with the performance of work under this contract, the contractor agrees to comply with all applicable state and federal statutes relating to non-discrimination in employment. No otherwise qualified person shall be excluded from employment or otherwise be subject to discrimination in employment in any manner on the basis of age, race, religion, color, gender, national origin or ancestry, disability, arrest or conviction record (in keeping with s.111.32), sexual orientation, marital status, membership in the military reserve, honesty testing, genetic testing, and outside use of lawful products. This provision shall include, but not be limited to the following: employment, upgrading, demotion or transfer; recruitment or recruitment advertising; layoff or termination; rates of pay or other forms of compensation, and selection for training, including apprenticeship. The contractor further agrees to ensure equal opportunity in employment to all applicants and employees and to take affirmative action to attain a representative workforce.

The contractor agrees to post notices and posters setting forth the provisions of the nondiscrimination clause, in a conspicuous and easily accessible place, available for employees and applicants for employment.

If a state public official (section 19.42, Stats.) or an organization in which a state public official holds at least a 10% interest is a party to this agreement, this contract is voidable by the state unless appropriate disclosure is made to the State of Wisconsin Ethics Board.



## BID PREPARATION

### Preparing the Proposal Schedule of Items

#### A. General

- (1) Obtain bidding proposals as specified in section 102 of the standard specifications prior to 11:45 AM of the last business day preceding the letting. Submit bidding proposals using one of the following methods:
  1. Electronic bid on the internet.
  2. Electronic bid on a printout with accompanying diskette or CD ROM.
  3. Paper bid under a waiver of the electronic submittal requirements.
- (2) Bids submitted on a printout with accompanying diskette or CD ROM or paper bids submitted under a waiver of the electronic submittal requirements govern over bids submitted on the internet.
- (3) The department will provide bidding information through the department's web site at:

<https://wisconsin.gov/Pages/doing-bus/contractors/hcci/bid-let.aspx>

The contractor is responsible for reviewing this web site for general notices as well as information regarding proposals in each letting. The department will also post special notices of all addenda to each proposal through this web site no later than 4:00 PM local time on the Thursday before the letting. Check the department's web site after 5:00 PM local time on the Thursday before the letting to ensure all addenda have been accounted for before preparing the bid. When bidding using methods 1 and 2 above, check the Bid Express™ on-line bidding exchange at <http://www.bidx.com/> after 5:00 PM local time on the Thursday before the letting to ensure that the latest schedule of items Expedite file (\*.ebs or \*.00x) is used to submit the final bid.

- (4) Interested parties can subscribe to the Bid Express™ on-line bidding exchange by following the instructions provided at the [www.bidx.com](http://www.bidx.com) web site or by contacting:

Info Tech Inc.  
5700 SW 34th Street, Suite 1235  
Gainesville, FL 32608-5371  
email: <mailto:customer.support@bidx.com>

- (5) The department will address equipment and process failures, if the bidder can demonstrate that those failures were beyond their control.
- (6) Contractors are responsible for checking on the issuance of addenda and for obtaining the addenda. Notice of issuance of addenda is posted on the department's web site at:

<https://wisconsin.gov/Pages/doing-bus/contractors/hcci/bid-let.aspx>

or by calling the department at (608) 266-1631. Addenda can ONLY be obtained from the department's web site listed above or by picking up the addenda at the Bureau of Highway Construction, 4th floor, 4822 Madison Yards Way, Madison, WI, during regular business hours.

- (7) Addenda posted after 5:00 PM on the Thursday before the letting will be emailed to the eligible bidders for that proposal. All eligible bidders shall acknowledge receipt of the addenda whether they are bidding on the proposal or not. Not acknowledging receipt may jeopardize the awarding of the project.

## B. Submitting Electronic Bids

### B.1 On the Internet

- (1) Do the following before submitting the bid:
  4. Have a properly executed annual bid bond on file with the department.
  5. Have a digital ID on file with and enabled by Info Tech Inc. Using this digital ID will constitute the bidder's signature for proper execution of the bidding proposal.
- (2) In lieu of preparing, delivering, and submitting the proposal as specified in 102.6 and 102.9 of the standard specifications, submit the proposal on the internet as follows:
  1. Download the latest schedule of items reflecting all addenda from the Bid Express™ web site.
  2. Use Expedite™ software to enter a unit price for every item in the schedule of items.
  3. Submit the bid according to the requirements of Expedite™ software and the Bid Express™ web site. Do not submit a bid on a printout with accompanying diskette or CD ROM or a paper bid. If the bidder does submit a bid on a printout with accompanying diskette or a paper bid in addition to the internet submittal, the department will disregard the internet bid.
  4. Submit the bid before the hour and date the Notice to Contractors designates.
  5. Do not sign, notarize, and return the bidding proposal described in 102.2 of the standard specifications.
- (3) The department will not consider the bid accepted until the hour and date the Notice to Contractors designates.

### B.2 On a Printout with Accompanying Diskette or CD ROM

- (1) Download the latest schedule of items from the Wisconsin pages of the Bid Express web site reflecting the latest addenda posted on the department's web site at:  
<https://wisconsin.gov/Pages/doing-bus/contractors/hcci/bid-let.aspx>  
 Use Expedite™ software to prepare and print the schedule of items. Provide a valid amount for all price fields. Follow instructions and review the help screens provided on the Bid Express™ web site to assure that the schedule of items is prepared properly.

- (2) Staple an 8 1/2 by 11 inch printout of the Expedite™ generated schedule of items to the other proposal documents submitted to the department as a part of the bidder's sealed bid. As a separate submittal, not in the sealed bid envelope but due at the same time and place as the sealed bid, also provide the Expedite™ generated schedule of items on a 3 1/2 inch computer diskette or CD ROM. Label each diskette or CD ROM with the bidder's name, the 4 character department-assigned bidder identification code from the top of the bidding proposal, and a list of the proposal numbers included on that diskette or CD ROM as indicated in the following example:

**Bidder Name**

**BN00**

**Proposals: 1, 12, 14, & 22**

- (3) If bidding on more than one proposal in the letting, the bidder may include all proposals for that letting on one diskette or CD ROM. Include only submitted proposals with no incomplete or other files on the diskette or CD ROM.
- (4) The bidder-submitted printout of the Expedite™ generated schedule of items is the governing contract document and must conform to the requirements of section 102 of the standard specifications. If a printout needs to be altered, cross out the printed information with ink or typewriter and enter the new information and initial it in ink. If there is a discrepancy between the printout and the diskette or CD ROM, the department will analyze the bid using the printout information.

- (5) In addition to the reasons specified in section 102 of the standard specifications, proposals are irregular and the department may reject them for one or more of the following:
1. The check code printed on the bottom of the printout of the Expedite™ generated schedule of items is not the same on each page.
  2. The check code printed on the printout of the Expedite™ generated schedule of items is not the same as the check code for that proposal provided on the diskette or CD ROM.
  3. The diskette or CD ROM is not submitted at the time and place the department designates.

#### **B Waiver of Electronic Submittal**

- (1) The bidder may request a waiver of the electronic submittal requirements. Submit a written request for a waiver in lieu of bids submitted on the internet or on a printout with accompanying diskette or CD ROM. Use the waiver that was included with the paper bid document sent to the bidder or type up a waiver on the bidder's letterhead. The department will waive the electronic submittal requirements for a bidding entity (individual, partnership, joint venture, corporation, or limited liability company) for up to 4 individual proposals in a calendar year. The department may allow additional waivers for equipment malfunctions.
- (2) Submit a schedule of items on paper conforming to section 102 of the standard specifications. The department charges the bidder a \$75 administrative fee per proposal, payable at the time and place the department designates for receiving bids, to cover the costs of data entry. The department will accept a check or money order payable to: "Wisconsin, Dept. of Transportation."
- (3) In addition to the reasons specified in section 102 of the standard specifications, proposals are irregular and the department may reject them for one or more of the following:
  1. The bidder fails to provide the written request for waiver of the electronic submittal requirements.
  2. The bidder fails to pay the \$75 administrative fee before the time the department designates for the opening of bids unless the bidder requests on the waiver that they be billed for the \$75.
  3. The bidder exceeds 4 waivers of electronic submittal requirements within a calendar year.
- (4) In addition to the reasons specified in section 102 of the standard specifications, the department may refuse to issue bidding proposals for future contracts to a bidding entity that owes the department administrative fees for a waiver of electronic submittal requirements.

**PROPOSAL BID BOND**

DT1303 1/2006

Wisconsin Department of Transportation

Proposal Number	Project Number	Letting Date
Name of Principal		
Name of Surety	State in Which Surety is Organized	

We, the above-named Principal and the above-named Surety, are held and firmly bound unto the State of Wisconsin in the sum equal to the Proposal Guaranty for the total bid submitted for the payment to be made; we jointly and severally bind ourselves, our heirs, executors, administrators, successors and assigns. The condition of this obligation is that the Principal has submitted a bid proposal to the State of Wisconsin acting through the Department of Transportation for the improvement designated by the Proposal Number and Letting Date indicated above.

If the Principal is awarded the contract and, within the time and manner required by law after the prescribed forms are presented for signature, enters into a written contract in accordance with the bid, and files the bond with the Department of Transportation to guarantee faithful performance and payment for labor and materials, as required by law, or if the Department of Transportation shall reject all bids for the work described, then this obligation shall be null and void; otherwise, it shall be and remain in full force and effect. In the event of failure of the Principal to enter into the contract or give the specified bond, the Principal shall pay to the Department of Transportation **within 10 business days of demand** a total equal to the Proposal Guaranty as liquidated damages; the liability of the Surety continues for the full amount of the obligation as stated until the obligation is paid in full.

The Surety, for value received, agrees that the obligations of it and its bond shall not be impaired or affected by any extension of time within which the Department of Transportation may accept the bid; and the Surety does waive notice of any such extension.

IN WITNESS, the Principal and Surety have agreed and have signed by their proper officers and have caused their corporate seals to be affixed this date: **(DATE MUST BE ENTERED)**

**PRINCIPAL**

\_\_\_\_\_  
(Company Name) **(Affix Corporate Seal)**

\_\_\_\_\_  
(Signature and Title)

\_\_\_\_\_  
(Company Name)

\_\_\_\_\_  
(Signature and Title)

\_\_\_\_\_  
(Company Name)

\_\_\_\_\_  
(Signature and Title)

\_\_\_\_\_  
(Company Name)

\_\_\_\_\_  
(Signature and Title)

\_\_\_\_\_  
(Name of Surety) **(Affix Seal)**

\_\_\_\_\_  
(Signature of Attorney-in-Fact)

**NOTARY FOR PRINCIPAL**

**NOTARY FOR SURETY**

\_\_\_\_\_  
(Date)

\_\_\_\_\_  
(Date)

State of Wisconsin )  
) ss.  
\_\_\_\_\_ County )

State of Wisconsin )  
) ss.  
\_\_\_\_\_ County )

On the above date, this instrument was acknowledged before me by the named person(s).

On the above date, this instrument was acknowledged before me by the named person(s).

\_\_\_\_\_  
(Signature, Notary Public, State of Wisconsin)

\_\_\_\_\_  
(Signature, Notary Public, State of Wisconsin)

\_\_\_\_\_  
(Print or Type Name, Notary Public, State of Wisconsin)

\_\_\_\_\_  
(Print or Type Name, Notary Public, State of Wisconsin)

\_\_\_\_\_  
(Date Commission Expires)

\_\_\_\_\_  
(Date Commission Expires)

**Notary Seal**

**Notary Seal**

**IMPORTANT: A certified copy of Power of Attorney of the signatory agent must be attached to the bid bond.**

# CERTIFICATE OF ANNUAL BID BOND

DT1305 8/2003

Wisconsin Department of Transportation

Time Period Valid (From/To)
Name of Surety
Name of Contractor
Certificate Holder Wisconsin Department of Transportation

This is to certify that an annual bid bond issued by the above-named Surety is currently on file with the Wisconsin Department of Transportation.

This certificate is issued as a matter of information and conveys no rights upon the certificate holder and does not amend, extend or alter the coverage of the annual bid bond.

**Cancellation:** Should the above policy be cancelled before the expiration date, the issuing surety will give thirty (30) days written notice to the certificate holder indicated above.

\_\_\_\_\_  
(Signature of Authorized Contractor Representative)

\_\_\_\_\_  
(Date)



## **CERTIFICATION REGARDING DEBARMENT, SUSPENSION, AND OTHER RESPONSIBILITY MATTERS - PRIMARY COVERED TRANSACTIONS**

### Instructions for Certification

1. By signing and submitting this proposal, the prospective contractor is providing the certification set out below.
2. The inability of a person to provide the certification required below will not necessarily result in denial of participation in this covered transaction. The prospective contractor shall submit an explanation of why it cannot provide the certification set out below. The certification or explanation will be considered in connection with the department or agency's determination whether to enter into this transaction. However, failure of the prospective contractor to furnish a certification or an explanation shall disqualify such person from participation in this transaction.
3. The certification in this clause is a material representation of fact upon which reliance was placed when the department determined to enter into this transaction. If it is later determined that the contractor knowingly rendered an erroneous certification in addition to other remedies available to the Federal Government the department may terminate this transaction for cause or default.
4. The prospective contractor shall provide immediate written notice to the department to whom this proposal is submitted if at any time the prospective contractor learns that its certification was erroneous when submitted or has become erroneous by reason of changed circumstances.
5. The terms "covered transaction," "debarred," "suspended," "ineligible," "lower tier covered transaction," "participant," "person," "primary covered transaction," "principal," "proposal," and "voluntarily excluded," as used in this clause, have the meanings set out in the Definitions and Coverage sections of the rules implementing Executive Order 12549. You may contact the department to which this proposal is being submitted for assistance in obtaining a copy of those regulations.
6. The prospective contractor agrees by submitting this proposal that, should this contract be entered into, it shall not knowingly enter into any lower tier covered transaction with a person who is debarred, suspended, declared ineligible, or voluntarily excluded from participation in this covered transaction, unless authorized by the department entering into this transaction.
7. The prospective contractor further agrees by submitting this proposal that it will include the clause titled "Certification Regarding Debarment, Suspension, Ineligibility and Voluntary Exclusion-Lower Tier Covered Transaction," which is included as an addendum to PR- 1273 - "Required Contract Provisions Federal Aid Construction Contracts," without modification, in all lower tier covered transactions and in all solicitations for lower tier covered transactions.
8. The contractor may rely upon a certification of a prospective subcontractor/materials supplier that it is not debarred, suspended, ineligible, or voluntarily excluded from the covered transaction, unless it knows that the certification is erroneous. A contractor may decide the method and frequency by which it determines the eligibility of its principals. Each contractor may, but is not required to, check the Disapproval List (telephone # 608/266/1631).

9. Nothing contained in the foregoing shall be construed to require establishment of a system of records in order to render in good faith the certification required by this clause. The knowledge and information of a contractor is not required to exceed that which is normally possessed by a prudent person in the ordinary course of business dealings.
10. Except for transactions authorized under paragraph 6 of these instructions, if a contractor in a covered transaction knowingly enters into a lower tier covered transaction with a person who is suspended, debarred, ineligible or voluntarily excluded from participation in this transaction, in addition to other remedies available to the Federal Government, the department may terminate this transaction for cause or default.

Certification Regarding Debarment, Suspension, and Other Responsibility Matters - Primary Covered Transactions

1. The prospective contractor certifies to the best of its knowledge and belief, that it and its principals:
  - (a) Are not presently debarred, suspended, proposed for debarment, declared ineligible, or voluntarily excluded from covered transactions by any Federal department or agency;
  - (b) Have not within a three-year period preceding this proposal been convicted of or had a civil judgment rendered against them for commission of fraud or a criminal offense in connection with obtaining, attempting to obtain, or performing a public (Federal, State or local) transaction or contract under a public transaction; violation of Federal or State antitrust statutes or commission of embezzlement, theft, forgery, bribery, falsification or destruction of records, making false statements or receiving stolen property;
  - (c) Are not presently indicted for or otherwise criminally or civilly charged by a governmental entity (Federal, State or local) with commission of any of the offense enumerated in paragraph (1)(b) of this certification; and
  - (d) Have not within a three-year period preceding this proposal had one or more public transactions (Federal, State or local) terminated for cause or default.
2. Where the prospective contractor is unable to certify to any of the statements in this certification, such prospective contractor shall attach an explanation to this proposal.



## Special Provisions

### Table of Contents

Article	Description	Page #
1.	General.....	6
2.	Scope of Work.....	6
3.	Prosecution and Progress.....	6
4.	Lane Rental Fee Assessment.....	13
5.	Traffic.....	13
6.	Traffic Meeting and Traffic Control Scheduling.....	19
7.	Holiday and Special Event Work Restrictions.....	19
8.	Utilities.....	19
9.	Other Contracts.....	22
10.	Hauling Restrictions.....	23
11.	Information to Bidders, WPDES Transportation Construction General Permit (TCGP) for Storm Water Discharges.....	23
12.	Environmental Protection, Aquatic Exotic Species Control.....	23
13.	Erosion Control.....	24
14.	Temporary Wetland Impacts.....	25
15.	Notice to Contractor – Airport Operating Restrictions.....	25
16.	Notice to Contractor – Notification of Demolition and/or Renovation No Asbestos Found.....	27
17.	Notice to Contractor – Traffic Signal, Lighting, FTMS, and Sign Structure Equipment Lead Time.....	27
18.	Notice to Contractor – Wisconsin Coach Lines/Coach USA.....	27
19.	Notice to Contractor – Waukesha Metro.....	28
20.	Contractor Document Submittals.....	28
21.	Nighttime Work Lighting-Stationary.....	29
22.	Material Stockpile and Equipment Storage.....	30
23.	Available Documents.....	30
24.	Removing Concrete Surface Partial Depth, Item 204.0109.S.....	30
25.	Removing Asphaltic Longitudinal Notched Wedge Joint Milling, Item 204.0126.S.....	31
26.	Removing Crash Cushion, Item 204.9060.S.001.....	32
27.	Removing Bicycle Rack, Item 204.9060.S.002.....	32
28.	Removing Existing Ramp Gate Assembly, Item 204.9060.S.003.....	32
29.	Removing Traffic Signals IH 94 EB Ramps & CTH SS, Item 204.9060.S.021; Removing Traffic Signals STH 318 & Silvernail Road, Item 204.9060.S.041; Removing Traffic Signals IH 94 EB Ramps & STH 318, Item 204.9060.S.051; Removing Traffic Signals IH 94 WB Ramps & STH 318, Item 204.9060.S.061; Removing Traffic Signals IH 94 EB Ramps & CTH T, Item 204.9060.S.071; Removing Traffic Signals IH 94 WB Ramps & CTH T, Item 204.9060.S.081.....	33
30.	Removing Loop Detector Wire and Lead-In Cable STH 318 & Silvernail Road, Item 204.9060.S.042; Removing Loop Detector Wire and Lead-In Cable IH 94 EB Ramps & STH 318, Item 204.9060.S.052; Removing Loop Detector Wire and Lead-In Cable IH 94 WB Ramps & STH 318, Item 204.9060.S.062; Removing Loop Detector Wire and Lead-In Cable IH 94 EB Ramps & CTH T, Item 204.9060.S.072; Removing Loop Detector Wire and Lead-In Cable IH 94 WB Ramps & CTH T, Item 204.9060.S.082.....	34
31.	Removing Lighting Units, Item 204.9060.S.401.....	35

32.	Removing Luminaires, Item 204.9060.S.402. ....	35
33.	Removing Cable Barrier, Item 204.9090.S.001. ....	36
34.	QMP HMA Pavement Nuclear Density. ....	36
35.	HMA Pavement 4 SMA 58-28 V, Item 460.8624; HMA Pavement Test Strip Volumetrics, Item 460.0115.S; HMA Pavement Test Strip Density, Item 460.0120.S. ....	39
36.	HMA Percent Within Limits (PWL) Test Strip Volumetrics, Item 460.0105.S; HMA Percent Within Limits (PWL) Test Strip Density, Item 460.0110.S. ....	41
37.	HMA Pavement Percent Within Limits (PWL) QMP. ....	46
38.	Appendix A. ....	54
39.	HMA Pavement Longitudinal Joint Density. ....	59
40.	Material Transfer Vehicle (1060-47-70), Item 460.9000.S.001. ....	63
41.	Removing Bearings B-67-245, Item 506.7050.S.001. ....	63
42.	Sawing Pavement Deck Preparation Areas, Item 509.0310.S. ....	64
43.	Concrete Masonry Deck Repair, Item 509.2100.S. ....	64
44.	Cleaning Parapets, Item 509.9050.S. ....	65
45.	Culvert Pipe Liners 18-Inch, Item 520.9700.S.001; Cleaning Culvert Pipes for Liner Verification, Item 520.9750.S. ....	66
46.	Cable Barrier Type 1, Item 613.1100.S; Cable Barrier End Terminal Type 1, Item 613.1200.S. ....	69
47.	Fence Safety, Item 616.0700.S. ....	70
48.	Topsoil and Salvaged Topsoil. ....	71
49.	Covering Signs. ....	71
50.	General Requirements for Electrical Work. ....	72
51.	Distribution Center Maintenance. ....	73
52.	Electrical Conduit. ....	74
53.	Install Conduit into Existing Item, Item 652.0700.S. ....	74
54.	Electrical Service Meter Breaker Pedestal STH 318 & Silvernail Road, Item 656.0201.041; Electrical Service Meter Breaker Pedestal IH 94 EB Ramps & STH 318, Item 656.0201.051; Electrical Service Meter Breaker Pedestal IH 94 WB Ramps & STH 318, Item 656.0201.061; Electrical Service Meter Breaker Pedestal IH 94 EB Ramps & CTH T, Item 656.0201.071; Electrical Service Meter Breaker Pedestal IH 94 WB Ramps & CTH T, Item 656.0201.081; Electrical Service Meter Breaker Pedestal MBDMS670040, Item 656.0201.300; Electrical Service Meter Breaker Pedestal MBCCTV670244, Item 656.0201.301. ....	74
55.	Signal Housings. ....	75
56.	Pedestrian Push Buttons. ....	75
57.	Traffic Signal Faces & Pedestrian Signal Face 16-Inch. ....	75
58.	Lamp, Ballast, LED, Switch Disposal by Contractor, Item 659.5000.S. ....	75
59.	Temporary Traffic Signals for Intersections STH 318 & Silvernail Road, Item 661.0201.041; Temporary Traffic Signals for Intersections IH 94 EB Ramps & STH 318, Item 661.0201.051; Temporary Traffic Signals for Intersections IH 94 WB Ramps & STH 318, Item 661.0201.061; Temporary Traffic Signals for Intersections IH 94 EB Ramps & CTH T, Item 661.0201.071; Temporary Traffic Signals for Intersections IH 94 WB Ramps & CTH T, Item 661.0201.081. ....	77
60.	Ramp Closure Gates 40-FT, Item 662.1040.S. ....	78
61.	Ramp Closure Barricade Rack 2-Unit, Item 662.6020.S; Ramp Closure Barricade Rack 3-Unit, Item 662.6030.S. ....	79
62.	Intelligent Transportation Systems (ITS) – Control of Materials. ....	80
63.	Intelligent Transportation Systems - General Requirements. ....	81

64.	Install ITS Field Cabinet, Item 673.1200.S	84
65.	Install Pole Mounted Cabinet, Item 673.1225.S	85
66.	Cameras	85
67.	Removing 50-FT Camera Pole, Item 677.9051.S	86
68.	Removing CCTV Camera, Item 677.9200.S	86
69.	Communication Systems	87
70.	Install Overhead Freeway DMS Full Matrix, Item 678.0100.S	87
71.	Bicycle Rack Asphalt or Concrete-Mounted, Item 999.1950.S	88
72.	Backfill Slurry, Item SPV.0035.001	89
73.	Basic Traffic Queue Warning System, Item SPV.0045.001	90
74.	Digital Speed Reduction System (DSRS); Item SPV.0045.002	92
75.	Tension Anchor Rods, Item SPV.0060.001	94
76.	Remove Grout Pad, Item SPV.0060.002	95
77.	Remove Debris and Regrade, Item SPV.0060.003	96
78.	Adjust Sign, Item SPV.0060.004	96
79.	U-Bolt, Item SPV.0060.005	97
80.	Remove Catwalk, Item SPV.0060.006	97
81.	Lower Structure, Item SPV.0060.007	98
82.	Re-install Truss/Arm, Item SPV.0060.008	99
83.	Vertical Sign Support, Item SPV.0060.009	100
84.	Strapping C-67-1570, Item SPV.0060.010	100
85.	Catwalk Repair, Item SPV.0060.011	101
86.	Replace Conduit Connector, Item SPV.0060.012	101
87.	Survey Project, Item SPV.0060.050	102
88.	Baseline CPM Progress Schedule, Item SPV.0060.051; Monthly CPM Progress Schedule Updates, Item SPV.0060.052	104
89.	Traffic Control Close-Open Freeway Entrance Ramp, Item SPV.0060.053	109
90.	Traffic Control Full Freeway Closure, Item SPV.0060.054	110
91.	Mobilization Emergency Pavement Repair, Item SPV.0060.055	110
92.	Field Facilities Office Space, Item SPV.0060.056	111
93.	Utility Line Opening (ULO), Item SPV.0060.057	112
94.	Section Corner Monuments Special, Item SPV.0060.058	113
95.	Remove and Reset Cable Barrier Post, Item SPV.0060.059	114
96.	Curb Ramp Grading and Shaping, Item SPV.0060.060	114
97.	Concrete Barrier Transition to Curb, Item SPV.0060.101	115
98.	Fastening Sewer Access Covers, Item SPV.0060.102	116
99.	Reset Existing Bearings, Item SPV.0060.103	116
100.	Install Poles Type 9, Item SPV.0060.201; Install Poles Type 9 Special, Item SPV.0060.202; Install Poles Type 10, Item SPV.0060.203; Install Poles Type 10 Special, Item SPV.0060.204; Install Poles Type 12, Item SPV.0060.205; Install Poles Type 13, Item SPV.0060.206; Install Monotube Arms 15-FT, Item SPV.0060.207; Install Monotube Arms 25-FT, Item SPV.0060.208; Install Monotube Arms 35-FT-Special, Item SPV.0060.209; Install Monotube Arms 45-FT-Special, Item	

	SPV.0060.210; Install Monotube Arms 50-FT, Item SPV.0060.211; Install Monotube Arms 55-FT, Item SPV.0060.212; Install Luminaire Arms Steel 15-FT, Item SPV.0060.213.....	117
101.	Traffic Signal Reflective Backplate 3S, Item SPV.0060.214; Traffic Signal Reflective Backplate 4S, Item SPV.0060.215. ....	118
102.	Trnspt & Install State Furn Traffic Signal Cabinet STH 318 & Silvernail Road, Item SPV.0060.216; Trnspt & Install State Furn Traffic Signal Cabinet IH 94 EB Ramps & STH 318, Item SPV.0060.217; Trnspt & Install State Furn Traffic Signal Cabinet IH 94 WB Ramps & STH 318, Item SPV.0060.218; Trnspt & Install State Furn Traffic Signal Cabinet IH 94 EB Ramps & CTH T, Item SPV.0060.219; Trnspt & Install State Furn Traffic Signal Cabinet IH 94 WB Ramps & CTH T, Item SPV.0060.220. ....	118
103.	Trnspt & Install State Furn EVP Heads & Con Light STH 318 & Silvernail Road, Item SPV.0060.221; Trnspt & Install State Furn EVP Heads & Con Light IH 94 EB Ramps & STH 318, Item SPV.0060.222; Trnspt & Install State Furn EVP Heads & Con Light IH 94 WB Ramps & STH 318, Item SPV.0060.223; Trnspt & Install State Furn EVP Heads & Con Light IH 94 EB Ramps & CTH T, Item SPV.0060.224; Trnspt & Install State Furn EVP Heads & Con Light IH 94 WB Ramps & CTH T, Item SPV.0060.225. ....	119
104.	Trnspt Traffic Signals & Inter Lighting Materials STH 318 & Silvernail Road, Item SPV.0060.226; Trnspt Traffic Signals & Inter Lighting Materials IH 94 EB Ramps & STH 318, Item SPV.0060.227; Trnspt Traffic Signals & Inter Lighting Materials IH 94 WB Ramps & STH 318, Item SPV.0060.228; Trnspt Traffic Signals & Inter Lighting Materials IH 94 EB Ramps & CTH T, Item SPV.0060.229; Trnspt Traffic Signals & Inter Lighting Materials IH 94 WB Ramps & CTH T, Item SPV.0060.230. ....	120
105.	Trnspt & Install S-F Radar Detection System IH 94 EB Ramps & CTH T, Item SPV.0060.231; Trnspt & Install S-F Radar Detection System IH 94 WB Ramps & CTH T, Item SPV.0060.232.....	121
106.	Airport Obstruction Lights L810, Item SPV.0060.233.....	122
107.	Concrete Control Cabinet Bases Type 9 Special Super P, Item SPV.0060.234.....	123
108.	Temporary EVP System STH 318 & Silvernail Road, Item SPV.0060.235; Temporary EVP System IH 94 EB Ramps & STH 318, Item SPV.0060.236; Temporary EVP System IH 94 WB Ramps & STH 318, Item SPV.0060.237; Temporary EVP System IH 94 EB Ramps & CTH T, Item SPV.0060.238; Temporary EVP System IH 94 WB Ramps & CTH T, Item SPV.0060.239.....	123
109.	Remove and Reinstall Fiber Optic Pigtail STH 318 & Silvernail Road, Item SPV.0060.250; Remove and Reinstall Fiber Optic Pigtail IH 94 EB Ramps & STH 318, Item SPV.0060.251; Remove and Reinstall Fiber Optic Pigtail IH 94 WB Ramps & STH 318, Item SPV.0060.252; Remove and Reinstall Fiber Optic Pigtail IH 94 EB Ramps & CTH T, Item SPV.0060.253; Remove and Reinstall Fiber Optic Pigtail IH 94 WB Ramps & CTH T, Item SPV.0060.254. ....	124
110.	Relocate Existing Pull Box, Item SPV.0060.255. ....	125
111.	Remove Pole, Item SPV.0060.300.....	125
112.	Ground Rod, Item SPV.0060.301.....	126
113.	Refocus Vehicle Detector Assembly, Item SPV.0060.302. ....	126
114.	Removing Controller Cabinet Base, Item SPV.0060.303. ....	127
115.	Removing Controller Cabinet, Item SPV.0060.304. ....	127
116.	Modify Lighting Control Cabinets 120/240, Item SPV.0060.401. ....	128
117.	Maintenance of Lighting Systems (1060-47-70), Item SPV.0060.402.....	128
118.	Lighting System Integrator (1060-47-70), Item SPV.0060.403.....	131
119.	Lighting System Survey (1060-47-70), Item SPV.0060.404.....	132
120.	Concrete Barrier 51-Inch Special, Item SPV.0090.001. ....	132
121.	Marking Epoxy 4-Inch Black Non Grooved, Item SPV.0090.002; Marking Epoxy 6-Inch Black Non Grooved, Item SPV.0090.003; Marking Epoxy 8-Inch Black Non Grooved, Item SPV.0090.004; Marking Epoxy 10-Inch Black Non Grooved, Item SPV.0090.005. ....	134
122.	Concrete Barrier Wall Epoxy Crack Sealing, Item SPV.0090.006.....	134

123.	Outdoor Rated Network Cable, Item SPV.0090.300. ....	135
124.	Cable Aerial Aluminum 6 AWG Triplex, Item SPV.0090.401. ....	135
125.	Repair Galvanized Coating, Item SPV.0165.001. ....	136
126.	Wall Modular Block Mechanically Stabilized Earth R-67-159, Item SPV.0165.002.....	137
127.	Concrete Barrier Wall Surface Repair, Item SPV.0165.003. ....	148
128.	Methacrylate Flood Seal, Item SPV.0180.001.....	149
129.	Resin Binder High Friction Surface Treatment, Item SPV.0180.002.....	151
130.	Micromilling for Base Patching, Item SPV.0180.003. ....	156
131.	HMA Longitudinal Joint Repair, Item SPV.0195.001.....	156
132.	Asphaltic Repair, Item SPV.0195.002. ....	157

## STSP'S Revised June 29, 2023

### SPECIAL PROVISIONS

#### 1. General.

Perform the work under this construction contract for Project 1060-10-71, IH 94 East West Freeway, CTH T and CTH JJ (B-67-240, 245), IH 94; Project 1060-47-70, IH 94 East West Freeway, STH 83 to STH 16, IH 94; Project 1330-47-71, City of Delafield, State Road 83, Nagawaukee Park and Ride Lot, State Road 83; and Project 2788-03-70, City of Waukesha, Meadowbrook Road, Rolling Ridge Dr to IH 94 EB Ramps, Meadowbrook Road, all projects located in Waukesha County, Wisconsin as the plans show and execute the work as specified in the State of Wisconsin, Department of Transportation, Standard Specifications for Highway and Structure Construction, 2024 Edition, as published by the department, and these special provisions.

If all or a portion of the plans and special provisions are developed in the SI metric system and the schedule of prices is developed in the US standard measure system, the department will pay for the work as bid in the US standard system.

100-005 (20230629)

#### 2. Scope of Work.

The work under this contract shall consist of removals, asphaltic surface milling, HMA pavement, concrete pavement, bridge rehabilitation, concrete base, base aggregate, cable barrier, traffic signals, FTMS, guardrail, grading, storm sewer, concrete curb and gutter, high friction surface treatment, Methacrylate flood seal, erosion control, traffic control, pavement marking, signing, and all incidental items necessary to complete the work as shown on the plans and included in the proposal and contract.

104-005 (20090901)

#### 3. Prosecution and Progress.

Begin work within 10 calendar days after the engineer issues a written notice to do so.

Provide the start date to the engineer in writing within a month after executing the contract but at least 14 calendar days before the preconstruction conference. Upon approval, the engineer will issue the notice to proceed within 10 calendar days before the approved start date.

To revise the start date, submit a written request to the engineer at least two weeks before the intended start date. The engineer will approve or deny that request based on the conditions cited in the request and its effect on the department's scheduled resources.

Do not begin 1060-10-71 Stage 2 contract work at CTH JJ before 6:00 AM Monday, July 22, 2024.

Winter shutdown will commence when all contract work required for the interim completion date of October 27, 2024 has been completed. Do not resume work until April 1, 2025 unless approved by the engineer. Provide a start date in writing at least 14 days prior to the planned recommencement of work in 2025. Upon approval the engineer will issue the notice to proceed within 10 days of the approved start date.

The contract time for completion is based on an expedited work schedule and may require extraordinary forces and equipment.

##### 1. Interim Completion and Liquidated Damages: October 27, 2024

Complete all work on IH 94, Park & Ride lots, CTH SS, STH 318/Meadowbrook Rd, CTH T, and CTH JJ except for above ground work associated with permanent signals, lighting, and the DMS sign structure by 11:59 PM on October 27, 2024.

The high friction surface treatment will require the contractor to pave those areas completely to allow time for cure and favorable temperatures to apply the final HFST. The contractor is expected to account for this in their schedule.

If the contractor fails to complete the work listed above by 11:59 PM on October 27, 2024, the department will assess the contractor \$4,000 in interim liquidated damages for each calendar day the contract work remains incomplete beyond 12:01 AM on October 28, 2024. An entire calendar day will be charged for any period of time within a calendar day that the work remains incomplete beyond 12:01 AM.

If contract time expires prior to completing all work specified in the contract, additional liquidated damages will be affixed according to standard spec 108.11.

## **2. Interim Completion and Liquidated Damages – IH 94 Median Barrier Replacement: 30 Calendar Days**

At the beginning of Stage A, close EB Lane 1 and the CTH SS EB entrance ramp to through traffic for a maximum of 30 calendar days. Do not reopen until completing the following work: crash cushions, concrete barrier replacement, and any median work that will require an extended closure of EB Lane 1.

If the contractor fails to complete the work necessary to reopen EB Lane 1 and the CTH SS EB entrance ramp to traffic within 30 calendar days, the department will assess the contractor \$8,000 in interim liquidated damages for each calendar day the contract work remains incomplete beyond 30 calendar days. An entire calendar day will be charged for any period of time within a calendar day that the road remains closed beyond 12:01 AM.

If contract time expires prior to completing all work specified in the contract, additional liquidated damages will be affixed according to standard spec 108.11.

## **3. Interim Completion and Liquidated Damages – STH 318 EB Entrance Ramp: 14 Calendar Days**

At the beginning of curb ramp and crash cushion construction, close the STH 318/IH 94 EB entrance ramp to through traffic for a maximum of 14 calendar days. Do not reopen until completing the following work: crash cushion and curb ramps.

If the contractor fails to complete the work necessary to reopen the STH 318/IH 94 EB entrance ramp to traffic within 14 calendar days, the department will assess the contractor \$2,000 in interim liquidated damages for each calendar day the contract work remains incomplete beyond 14 calendar days. An entire calendar day will be charged for any period of time within a calendar day that the road remains closed beyond 12:01 AM.

If contract time expires prior to completing all work specified in the contract, additional liquidated damages will be affixed according to standard spec 108.11.

## **4. Interim Completion and Liquidated Damages – Nagawaukee Park and Ride Lot: 30 Calendar Days**

At the beginning of the Nagawaukee Park and Ride lot construction, stage the lot with closures for a maximum of 30 calendar days, not including Summerfest, State Fair, or the Republican National Convention. Keep the park and ride lot operational during construction, following the staging as shown in the traffic control plans or as modified by the engineer. Do not fully reopen until completing the following work: milling, paving, pavement marking, signing, and curb ramps.

If the contractor fails to complete the work necessary to reopen the park and ride lot to traffic within 30 calendar days, the department will assess the contractor \$1,000 in interim liquidated damages for each calendar day the contract work remains incomplete beyond 30 calendar days. An entire calendar day will be charged for any period of time within a calendar day that the lot has closures beyond 12:01 AM.

If contract time expires prior to completing all work specified in the contract, additional liquidated damages will be affixed according to standard spec 108.11.

## **5. Interim Completion and Liquidated Damages – Meadowbrook Park and Ride Lot: 30 Calendar Days**

At the beginning of the Meadowbrook Park and Ride lot construction, stage the lot with closures for a maximum of 30 calendar days, not including Summerfest, State Fair, or the Republican National Convention. Keep the park and ride lot operational during construction, following the staging as shown in the traffic control plans or as modified by the engineer. Do not fully reopen until completing the following work: milling, paving, pavement marking, signing, and curb ramps.

If the contractor fails to complete the work necessary to reopen the park and ride lot to traffic within 30 calendar days, the department will assess the contractor \$1,000 in interim liquidated damages for each calendar day the contract work remains incomplete beyond 30 calendar days. An entire calendar day will be charged for any period of time within a calendar day that the lot remains closed beyond 12:01 AM.

If contract time expires prior to completing all work specified in the contract, additional liquidated damages will be affixed according to standard spec 108.11.

#### **6. Interim Completion and Liquidated Damages – CTH JJ: 45 Calendar Days**

Do not begin 1060-10-71 Stage 2 contract work at CTH JJ before 6:00 AM Monday, July 22, 2024.

By the end of CTH JJ Stage 2, all work on the CTH JJ structure and roadway shall be completed. For CTH JJ Stage 2, close and detour traffic for a maximum of 45 consecutive calendar days. Do not reopen until completing the following work: concrete deck sealing, approach slab reconstruction, HMA Paving, and all other work required to open the roadway to the pre-construction traffic pattern.

If the contractor fails to complete the work necessary to reopen CTH JJ to traffic within 45 calendar days, the department will assess the contractor \$2,500 in interim liquidated damages for each calendar day the contract work remains incomplete beyond 45 calendar days. An entire calendar day will be charged for any period of time within a calendar day that the road remains closed beyond 12:01 AM.

If contract time expires prior to completing all work specified in the contract, additional liquidated damages will be affixed according to standard spec 108.11.

#### **7. Interim Completion and Liquidated Damages – C-67-0025: 21 Calendar Days**

For the C-67-0025 wingwall construction, complete the repairs within a maximum of 21 calendar days to reduce the environmental impacts on in-stream work occurring. Once the bottom apron has been removed, the new apron shall be poured with concrete within 3 calendar days. Work must be completed in dry conditions, either naturally or through dewatering, pumping or temporary diversion devices which are considered incidental to the project. The work must be completed according to the Erosion Control section of these special provisions.

If the contractor fails to complete the work listed above within 21 calendar days, the department will assess the contractor \$1,000 in interim liquidated damages for each calendar day the contract work remains incomplete beyond 21 calendar days. An entire calendar day will be charged for any period of time within a calendar day that the lot remains closed beyond 12:01 AM.

If contract time expires prior to completing all work specified in the contract, additional liquidated damages will be affixed according to standard spec 108.11.

#### **Contractor Coordination**

Attend weekly scheduling meetings to discuss the near-term schedule activities, address any long-term schedule issues, and discuss any relevant technical issues. Develop a rolling three-week schedule identifying the previous week worked and a two week "look ahead". Provide sufficient detail to include actual and planned activities and all the subcontractors for offsite and construction activities, addressing all activities including ramp and lane closure schedules to be performed and identifying issues requiring engineering action or input. Subcontractors shall attend the weekly progress meetings if identified on the two week "look ahead".

#### **Work By Others**

All trees required for removal within the slope intercepts will be cut down by Waukesha County Maintenance prior to April 1, 2024 and left in place for the roadway contractor to remove the material from the project area paid for under the Clearing contract bid item.

#### **Schedule of Operations**

Traffic shifts shown in each stage may occur at different times during that stage, depending on the controlling elements for a given traffic movement. Work can be completed on eastbound and westbound IH 94 simultaneously. Traffic shall be in the normal lanes during peak hours in all stages except Stage A. The long-term closure will be in Stage A for the IH 94 EB left lane from CTH SS to STH 16. The mainline staging was separated into two sections to account for the separate cross-sectional elements and the



differing work operations within them. The sections, from west to east are: Rural 4-lane section and Urban 6-lane section. Roadside barrier work and associated grading can occur concurrent with the roadway work but should not commence until after the traffic shifts onto the shoulder are complete. Do not move to the next stage until all work in the current stage or substage is completed or as approved by the engineer. The department anticipates that the schedule for each stage should be as follows:

IH 94 Rural Staged Construction:

- Stage 1
  - Repair shoulders as directed by the engineer.
  - Mill and pave shoulder rumble strips as needed for traffic shifts onto the shoulder.
  - Short term single lane closures permitted during night-time hours only in active work zone where work is occurring.
- Stage 2
  - Base patching concrete in lanes 1 and 2.
  - If needed to improve ride quality prior to asphalt paving and prior to special events, micromill the base patches.
  - Short term single lane closures permitted during night-time hours only in active work zone where work is occurring, with traffic partially shifted onto shoulders.
- Stage 3
  - Mill and overlay lower layers of lanes 1 and 2.
  - Short term single lane closures permitted during night-time hours only in active work zone where work is occurring, with traffic partially shifted onto shoulders.
- Stage 4A
  - Mill and overlay upper layer of inside shoulders.
  - Short term single lane closures permitted during night-time hours only in active work zone where work is occurring.
  - Milled surface on shoulder can remain during the day with shoulder closures in place.
- Stage 4B
  - Overlay upper layer of lane 1.
  - Construct methacrylate deck seals on inner half of bridges B-67-0060 and B-67-0061.
  - Short term single lane closures permitted during night-time hours only in active work zone where work is occurring, with traffic partially shifted onto shoulders.
- Stage 4C
  - Overlay upper layer of lane 2.
  - Construct methacrylate deck seals on outer half of bridges B-67-0060 and B-67-0061.
  - Place final pavement markings.
  - Construct outside roadside barrier.
  - Short term single lane closures permitted during night-time hours only in active work zone where work is occurring, with traffic partially shifted onto shoulders.
- Stage 4D
  - Mill and overlay upper layer of outside shoulders.
  - Construct shoulder rumble strips and place final pavement markings.
  - Short term single lane closures permitted during night-time hours only in active work zone where work is occurring.
  - Milled surface on shoulder can remain during the day with shoulder closures in place.

- Stage 5
  - Construct median roadside barrier.
  - Construct inside shoulder rumble strips.
  - Place final pavement markings.
  - Short term single lane closures permitted during night-time hours only in active work zone where work is occurring.

IH 94 Urban Staged Construction:

- Stage A
  - Replace median barrier wall.
  - Short term single lane closures permitted during night-time hours only in active work zone where work is occurring.
  - Daytime ingress/egress only from IH 94 eastbound.
  - Eastbound lane 1 long-term single lane closure with traffic shift from lanes 1 and 2 into lanes 2 and 3.
  - CTH SS eastbound entrance ramp long term closure.
- Stage B
  - Base patching concrete and concrete pavement repairs in lanes 1, 2, and 3.
  - If needed to improve ride quality prior to asphalt paving and prior to special events, micromill the base patches.
  - Short term dual lane closures permitted during night-time hours only in active work zone where work is occurring, traffic may be partially shifted onto shoulders for work in lane 2.
- Stage C
  - Mill outside shoulder.
  - Mill and overlay lower layer of lane 3.
  - Pave upper layer of lane 3.
  - Pave upper layer of outside shoulder.
  - Short term dual lane closures permitted during night-time hours only in active work zone where work is occurring.
  - Milled surface on shoulder can remain during the day with shoulder closures in place.
- Stage D
  - Mill inside shoulder.
  - Mill and overlay lower layer of lane 1.
  - Mill and overlay lower layer of lane 2.
  - Pave upper layer of lane 2.
  - Pave upper layer of lane 1.
  - Pave upper layer of inside shoulder.
  - Place final pavement markings and construct inside shoulder rumble strips.
  - Short term dual lane closures permitted during night-time hours only in active work zone where work is occurring, with traffic partially shifted onto shoulders.
  - Milled surface on shoulder can remain during the day with shoulder closures in place.
- Stage E
  - Place final pavement markings and construct outside shoulder rumble strips.
  - Short term dual lane closures permitted during night-time hours only in active work zone where work is occurring.

#### CTH T (B-67-0245):

- Stage 1
  - Prior to stage 1A:
  - Install temporary signals and remove portions of outside curb and gutter as shown on the cross over paving plan.
  - Single lane off-peak outside lane closures.
- Stage 1A
  - Remove the median and pave cross over. Add temporary pavement marking for use in Stage 1B.
  - Close median lanes. Traffic in outside lanes.
- Stage 1B
  - Traffic on west half of the structure, work on the east half. Work includes deck sealing, semi expansion abutment conversion, curb and gutter, and safety island at the eastbound on ramp.
- Stage 1C
  - Traffic on east half of the structure, work on the west. Work includes deck sealing, semi expansion abutment conversion, curb and gutter, and safety islands at the westbound on ramp and eastbound off ramp.
- Stage 1D
  - Remove cross over pavement and reconstruct median.
  - Close median lanes. Traffic on outside.
- Post Stage 1D
  - Single lane NB outside lane closure.

#### CTH JJ (B-67-0240):

- Stage 2
  - Do not begin 1060-10-71 Stage 2 contract work at CTH JJ before 6:00 AM Monday, July 22, 2024.
  - Deck sealing, re-sealing slopes, HMA paving, storm sewer, beam guard, approach slabs and all incidental work along CTH JJ.
  - CTH JJ closed and traffic detoured using STH 164, IH 94, and STH 16. IH 94 shoulder closure allowed during off-peak weekday and weekend hours for re-sealing slopes.

#### Additional Construction:

- Mill and overlay a portion of the park and ride lots under a partial closure and complete the ADA curb ramps with temporary bus stops and temporary pedestrian ramps, as needed.
- At CTH SS and STH 318, complete the methacrylate deck seals under short term night-time lane closures.
- At CTH SS, complete the traffic signal modification work and mill & resurface the asphalt under short term lane closures.
- At STH 318/CTH G/Meadowbrook Road, install/replace ramp gates, reconstruct traffic signals, construct ADA curb ramps, and mill & resurface the asphalt with short term lane closures and a STH 318 NB long term right lane closure over the bridge as shown in the plans. Complete storm sewer and median realignment work with short term lane closures.
- IH 94 WB east of Elmhurst Road, construct the DMS structure and permanent roadside barrier under night-time lane closures, long term shoulder closures, night-time rolling closures (as needed), and night-time full IH 94 WB closures for setting the truss and DMS. Temporary barrier is needed to construct the DMS, so this work needs to be coordinated with the mainline staging.
- Complete IH 94 WB cross culvert replacement work under IH 94 WB full freeway closures. Additional culvert repair to be completed under short term shoulder closures and night-time lane closures.

## **Work Zone Restrictions**

Modifications to the CTH SS and IH 94 EB Ramps traffic signal shall take place after the 14-day closure of the STH 318 eastbound entrance ramp closure.

## **Fish Spawning**

There shall be no instream disturbance or adjacent grading of Zion Creek (C-67-0865) at Station 593+33 and the tributary to Zion Creek at Station 606+50 (C-67-1570) as a result of construction activity under or for this contract, from March 1 to June 15 both dates inclusive, in order to avoid adverse impacts to fish and other aquatic organisms during sensitive time periods such as spawning and migration.

Any change to this limitation will require submitting a written request by the contractor to the engineer, subsequent review and concurrence by the Department of Natural Resources in the request, and final approval by the engineer. The approval will include all conditions to the request as mutually agreed upon by WisDOT and DNR.

## **Migratory Birds**

Swallow or other migratory bird nests have been observed on the following structures; however, deterrent is not needed because (1) construction activities that may affect the underside or interior of structure(s) will not occur during the migratory bird nesting season, or (2) it has been determined that anticipated construction activities on the structure will not disturb active nests. If it is later determined during construction that the nests will be disturbed the contractor shall implement avoidance/deterrent measures or obtain a depredation permit. All active nests (when eggs or young are present) of migratory birds are protected under the federal Migratory Bird Treaty Act. The nesting season for swallows and other birds is from April 15 to August 31:

- C-67-0866

## **Northern Long-eared Bat (*Myotis septentrionalis*)**

Northern long-eared bats (NLEB) have the potential to inhabit the project limits because they roost in trees, bridges, and culverts. Roosts may not have been observed on this project, but conditions to support the species exist. The species and all active roosts are protected by the federal Endangered Species Act. If an individual bat or active roost is encountered during construction operations, stop work, and notify the engineer and the WisDOT Regional Environmental Coordinator (REC).

Ensure all operators, employees, and subcontractors working in areas of known or presumed bat habitat are aware of environmental commitments and avoidance and minimization measures (AMMs) to protect both bats and their habitat.

Direct temporary lighting, if used, away from wooded areas during the bat active season April 1 to October 31, both dates inclusive.

The department has contracted with others and will perform the following operations after October 31 and prior to April 1:

- Cutting trees.

Remove any downed trees and grub the stumps and any remaining vegetation within the identified grubbing limits.

If there are clearing operations required to remove previously cut trees, submit a schedule and description with the ECIP 14 days prior to the work. The department will determine, based on schedule and scope of work, what additional erosion control measures shall be implemented prior to the start of clearing operations, and list those additional measures in the approval letter for the ECIP.

Contractor means and methods to remove additional trees will not be allowed. If it is determined that additional trees with a 3-inch or greater diameter at breast height (dbh) need to be removed beyond contractor means and methods, notify the engineer to coordinate with the WisDOT REC to determine if consultation with United States Fish and Wildlife Service (USFWS) is required. The contractor must be aware that the WisDOT REC and/or USFWS may not permit modifications.

#### **4. Lane Rental Fee Assessment.**

##### **A General**

The contract designates some lane closures to perform the work. The contractor will not incur a Lane Rental Fee Assessment for closing lanes during the allowable lane closure times. The contractor will incur a Lane Rental Fee Assessment for each lane closure outside of the allowable lane closure times. If a lane is obstructed at any time due to contractor operations, it is considered a closure. The purpose of lane rental is to enforce compliance of lane restrictions and discourage unnecessary closures.

The allowable lane closure times are shown in the Traffic article.

Submit the dates of the proposed lane, ramp, and roadway restrictions to the engineer as part of the progress schedule.

##### **B Lane Rental Fee Assessment**

The Lane Rental Fee Assessment incurred for each lane closure, each ramp closure, and each full closure of a roadway, per direction of travel, is as follows:

- IH 94 Mainline Night Time Lane Closure Extending into Weekday Peak Hours - \$6,000 per lane, per direction of travel, per hour broken into 15-minute increments
- IH 94 Mainline Night Time Lane Closure Extending into Weekend Peak Hours - \$3,000 per lane, per direction of travel, per hour broken into 15-minute increments
- Local Road Night Time Lane/Full Closure Extending into Peak Hours - \$1,000 per lane, per direction of travel, per hour broken into 15-minute increments
- CTH T Lane Closure Extending into Peak Hours - \$1,000 per lane, per direction of travel, per hour broken into 15-minute increments
- Service Ramps - \$1,000 per ramp, per direction of travel, per hour broken into 15-minute increments
- Full Freeway Closure:
  - 4:30 AM to 5:30 AM- \$1,500 per lane, per direction of travel, per hour broken into 15-minute increments
  - After 5:30 AM: \$6,000 per lane, per direction of travel, per hour broken into 15-minute increments

The Lane Rental Fee Assessment represents a portion of the cost of the interference and inconvenience to the road users for each closure. All lane, roadway, or ramp closure event increments 15 minutes and less will be assessed as a 15-minute increment.

The engineer, or designated representative, will be the sole authority in determining time period length for the Lane Rental Fee Assessment.

Lane Rental Fee Assessments will not be assessed for closures due to crashes, accidents or emergencies not initiated by the contractor.

The department will assess Lane Rental Fee Assessment by the dollar under the administrative item Failing to Open Road to Traffic. The total dollar amount of Lane Rental Fee Assessment will be computed by multiplying the Lane Rental Assessment Rate by the number of 15-minute increments of each lane closure event as described above.

Lane Rental Fee Assessment will be in effect from the time of the Notice to Proceed until the department issues final acceptance. If interim completion time or contract time expires before the completion of specified work in the contract, additional liquidated damages will be assessed as specified in standard spec 108.11 or as specified within this contract.

stp-108-070 (20161130)

#### **5. Traffic.**

##### **General**

*Supplement standard spec 643.3.1 with the following:*

IH 94 is an OSOW route. All fixed message and width restricted signs must be in place prior to the beginning of the width restricted stage to inform multi trip permit holders to utilize alternate routes. See Wisconsin Lane Closure System Advance Notification article to address lane restrictions in LCS.

Provide the Waukesha County Sheriff's Department, the Wisconsin State Patrol, City of Delafield Police Department, City of Waukesha Police Department, and the engineer a current telephone number with which the contractor or his representative can be contacted during non-working hours in the event a safety hazard develops.

Yield to all through traffic at all locations. Equip all vehicles or equipment operating in the live traffic lanes with a hazard identification beam (flashing yellow signal light) that is visible from 360 degrees. Operate the flashing yellow beam only when merging or exiting live traffic lanes or when parked or operating on shoulders, except when parked behind barrier wall. Do not park personal vehicles within the access control limits of the freeway. Do not cross live traffic lanes of IH 94 with equipment or vehicles.

Provide minimum 24-hour advance notification to the engineer for any LCS cancellations (not related to weather).

Do not disturb, remove, or obliterate any traffic control signs, advisory signs, sand barrel array, shoulder delineators or beam guard in place along the traveled roadways without the approval of the engineer.

SER-643-001 (20230214)

CTH JJ will be detoured for the duration of the deck sealing, beam guard and roadway work. CTH T will be constructed under traffic with crossovers.

### **Freeway Work Restriction Definitions**

The following definitions apply to this contract for freeway work restrictions:

- **Weekday Peak Hours**
  - 5:30 AM – 8:00 PM STH 83 to CTH SS (Monday, Tuesday, Wednesday, Thursday)
  - 5:30 AM – 9:00 PM STH 83 to CTH SS (Friday)
  - 5:30 AM – 7:00 PM CTH SS to CTH T (Monday, Tuesday, Wednesday, Thursday)
  - 5:30 AM – 8:00 PM CTH SS to CTH T (Friday)
  - 5:00 AM – 7:00 PM CTH T to CTH JJ (Monday, Tuesday, Wednesday)
  - 5:00 AM – 8:00 PM CTH T to CTH JJ (Thursday, Friday)
- **Weekday Off-Peak Hours**
  - 7:00 PM – 8:00 PM CTH SS to CTH T (Monday, Tuesday, Wednesday, Thursday)
  - 8:00 PM – 9:00 PM CTH SS to CTH T (Friday)
  - 7:00 PM – 11:00 PM CTH T to CTH JJ (Monday, Tuesday, Wednesday)
  - 8:00 PM – 11:00 PM CTH T to CTH JJ (Thursday, Friday)
- **Weekday Night-time Hours**
  - 8:00 PM - 5:30 AM STH 83 to CTH SS (Monday PM to Tuesday AM, Tuesday PM to Wednesday AM, Wednesday PM to Thursday AM, Thursday PM to Friday AM)
  - 9:00 PM - 8:00 AM STH 83 to CTH SS (Friday PM to Saturday AM)
  - 8:00 PM - 5:30 AM CTH SS to CTH T (Monday PM to Tuesday AM, Tuesday PM to Wednesday AM, Wednesday PM to Thursday AM, Thursday PM to Friday AM)
  - 9:00 PM - 8:00 AM CTH SS to CTH T (Friday PM to Saturday AM)
  - 11:00 PM - 5:00 AM CTH T to CTH JJ (Monday PM to Tuesday AM, Tuesday PM to Wednesday AM, Wednesday PM to Thursday AM, Thursday PM to Friday AM)
  - 11:00 PM - 7:00 AM CTH T to CTH JJ (Friday PM to Saturday AM)
- **Weekend Peak Hours**
  - 8:00 AM – 9:00 PM STH 83 to CTH SS (Saturday, Sunday)
  - 8:00 AM – 6:00 PM CTH SS to CTH T (Saturday, Sunday)
  - 9:00 AM – 6:00 PM CTH T to CTH JJ (Saturday)
  - 10:00 AM – 9:00 PM CTH T to CTH JJ (Sunday)

- Weekend Off-Peak Hours
  - 6:00 PM – 9:00 PM CTH SS to CTH T (Saturday, Sunday)
  - 6:00 PM – 11:00 PM CTH T to CTH JJ (Saturday)
  - 9:00 PM – 10:00 PM CTH T to CTH JJ (Sunday)
- Weekend Night-time Hours
  - 9:00 PM - 8:00 AM STH 83 to CTH SS (Saturday PM to Sunday AM)
  - 9:00 PM - 5:30 AM STH 83 to CTH SS (Sunday PM to Monday AM)
  - 9:00 PM - 8:00 AM CTH SS to CTH T (Saturday PM to Sunday AM)
  - 9:00 PM - 5:30 AM CTH SS to CTH T (Sunday PM to Monday AM)
  - 11:00 PM - 7:00 AM CTH T to CTH JJ (Saturday PM to Sunday AM)
  - 10:00 PM - 5:30 AM CTH T to CTH JJ (Sunday PM to Monday AM)

### **Freeway Work Restrictions**

#### IH 94 from west limit (STH 83) to CTH SS

- Single Lane Closures:
  - 8:00 PM - 5:30 AM (Monday PM to Tuesday AM, Tuesday PM to Wednesday AM, Wednesday PM to Thursday AM, Thursday PM to Friday AM)
  - 9:00 PM - 8:00 AM (Friday PM to Saturday AM, Saturday PM to Sunday AM)
  - 9:00 PM - 5:30 AM (Sunday PM to Monday AM)
- Full Closures:
  - 11:00 PM - 4:30 AM (Sunday PM to Monday AM, Monday PM to Tuesday AM, Tuesday PM to Wednesday AM, Wednesday PM to Thursday AM, Thursday PM to Friday AM)
  - 11:00 PM - 6:00 AM (Friday PM to Saturday AM, Saturday PM to Sunday AM)

#### IH 94 from CTH SS to CTH T

- Single Lane Closures:
  - 7:00 PM - 5:30 AM (Monday PM to Tuesday AM, Tuesday PM to Wednesday AM, Wednesday PM to Thursday AM, Thursday PM to Friday AM)
  - 8:00 PM - 8:00 AM (Friday PM to Saturday AM)
  - 6:00 PM - 8:00 AM (Saturday PM to Sunday AM)
  - 6:00 PM - 5:30 AM (Sunday PM to Monday AM)
- Dual Lane Closures:
  - 8:00 PM - 5:30 AM (Monday PM to Tuesday AM, Tuesday PM to Wednesday AM, Wednesday PM to Thursday AM, Thursday PM to Friday AM)
  - 9:00 PM - 8:00 AM (Friday PM to Saturday AM, Saturday PM to Sunday AM)
  - 9:00 PM - 5:30 AM (Sunday PM to Monday AM)

#### IH 94 from CTH T to east limit (CTH JJ)

- Single Lane Closures:
  - 7:00 PM - 5:30 AM (Monday PM to Tuesday AM, Tuesday PM to Wednesday AM, Wednesday PM to Thursday AM)
  - 8:00 PM - 5:30 AM (Thursday PM to Friday AM)
  - 8:00 PM - 9:00 AM (Friday PM to Saturday AM)
  - 6:00 PM - 10:00 AM (Saturday PM to Sunday AM)
  - 9:00 PM - 5:30 AM (Sunday PM to Monday AM)

- Dual Lane Closures:
  - 11:00 PM - 5:00 AM (Monday PM to Tuesday AM, Tuesday PM to Wednesday AM, Wednesday PM to Thursday AM, Thursday PM to Friday AM)
  - 11:00 PM - 7:00 AM (Friday PM to Saturday AM, Saturday PM to Sunday AM)
  - 10:00 PM - 5:30 AM (Sunday PM to Monday AM)

#### Service Ramps Lane Closure and Full Closure Hours

- 8:00 PM - 6:00 AM (Monday PM to Tuesday AM, Tuesday PM to Wednesday AM, Wednesday PM to Thursday AM, Thursday PM to Friday AM)
- 8:30 PM - 8:30 AM (Friday PM to Saturday AM, Saturday PM to Sunday AM)
- 8:30 PM - 6:00 AM (Sunday PM to Monday AM)

Do not close freeway lanes or shoulders (including auxiliary lanes, system ramps and service ramps) and ensure the freeway is entirely clear for traffic during Weekday Peak Hours and Weekend Peak Hours, except as shown in the traffic control plans.

One freeway lane and/or shoulder may be closed on the freeway and system ramps during Weekday Off-Peak hours, Weekend Off-Peak Hours, and Night-time Hours, but it must be approved by the engineer.

Two freeway lanes or shoulders (including auxiliary lanes, system ramps, service ramps and CD roadway system) may be closed only during Night-time Hours, but it must be approved by the engineer.

#### **Full Freeway Closures**

WB IH 94 from STH 83 to CTH SS – Full closures of IH 94 WB from STH 83 to CTH SS will be needed for the S-67-420 DMS installation and cross culvert replacement work.

Closures must be approved by the engineer.

#### **Ramp Closures**

Obtain prior acceptance from the engineer for ramp closures. Long-term ramp closures shown on the traffic control plans shall be posted 10 business days in advance of their closure with dates and time of closure.

All short-term entrance and exit ramp closures shall be posted 3 business days in advance of their closure with date(s) and time(s) of the closure.

No two consecutive entrance ramps or consecutive exit ramps may be closed unless it is shown in the traffic control plans or approved by the engineer. The CTH SS eastbound entrance ramp and the STH 318 eastbound entrance ramp shall not be closed long-term at the same time.

#### **Rolling Closure**

Short term freeway mainline rolling closures may be allowed for a maximum of 15 minutes for the removal and erection of sign structures, equipment moves across the road, or other required work as determined by the engineer. The department will allow short-term rolling closures only between 2:00 AM and 4:00 AM, and they may only be performed by freeway law enforcement.

Obtain approval from the engineer before coordinating these closures with freeway law enforcement. Coordinate 14 calendar days before closure. Present the scheduled time for the short-term rolling closure at the weekly traffic meeting a minimum of one week before the closure.



## **Local Road Work Restrictions**

- Peak Hours
  - 6:00 AM - 7:00 PM (Monday, Tuesday, Wednesday, Thursday, Friday, Saturday, Sunday)
- CTH T Peak Hours
  - 6:00 AM - 9:00 AM (Monday, Tuesday, Wednesday, Thursday, Friday)
  - 3:00 PM - 7:00 PM (Monday, Tuesday, Wednesday, Thursday, Friday)
- CTH T Off-Peak Hours
  - 9:00 AM - 3:00 PM (Monday, Tuesday, Wednesday, Thursday, Friday)
  - 7:00 PM - 6:00 AM (Monday, Tuesday, Wednesday, Thursday, Friday)

### CTH SS/STH 318

- Single Lane Closure
  - 7:00 PM - 6:00 AM (Monday, Tuesday, Wednesday, Thursday, Friday, Saturday, Sunday)

Flagging operations on Golf Road west of CTH SS for culvert replacement does not have restrictions.

Comply with all local ordinances that apply to local street work operations, including those pertaining to working during night-time hours. Furnish any ordinance variance issued by the municipality or required permits to the engineer in writing three days prior to performing such work.

Existing trees, street light poles, hydrants and other utility poles are to remain in place during construction unless otherwise noted in the plan. Conduct an on-site visit prior to bidding to determine any special measures required for proper clearance between the trees, hydrants and poles and the paving equipment.

Inform property owners and tenants at least 48 hours prior to removing a driveway approach that serves that property. Schedule driveway approach removal and replacement so that the time lapse between removal and replacement is seven days or less.

Do not close residential approaches or remove from service without giving five day notice to the occupants of the premises to remove their vehicles prior to driveway removal or closing of the driveway approach access. If necessary, make other access arrangements, agreed to in writing and signed by the contractor and the property owner serviced by the driveway. Obtain approval from the engineer prior to alternating construction sequencing.

## **Work Zone Ingress/Egress**

All locations of work zone egress or ingress for construction vehicles are subject to approval from the engineer. Submit to the engineer locations for freeway access into and out of the work zone for each stage and plans, for approval, that include signage and parallel deceleration and acceleration lanes for each freeway access into and out of the work zones. Submit the locations and plans 14 calendar days prior to each stage for approval by the engineer. This will be an official submittal as defined in section 103.10.2.4 of the Contract Award and Execution located elsewhere in these Special Provisions.

At the weekly traffic meetings, provide updated information to the Work Zone Access Plan, as approved by the engineer, to direct emergency responders accessing a mainline median barrier restricted work zone.

Access into the work zones is not allowed directly from the freeway during peak hours. Access into the work zones from the freeway will be allowed at other times, subject to approval by the engineer, if operations can be safely accomplished and do not result in non-construction traffic entering the work zones. Exiting work zones directly onto the freeway are only allowed when operations do not obstruct or slow traffic on the freeway. All construction vehicles shall yield to all through traffic at all locations.

## **Portable Changeable Message Signs**

Obtain acceptance from the engineer regarding the wording of all messages on portable changeable message signs prior to placing the message.

## Wisconsin Lane Closure System Advance Notification

Provide the following advance notification to the engineer for incorporation into the Wisconsin Lane Closure System (LCS).

**TABLE 108-1 CLOSURE TYPE AND REQUIRED MINIMUM ADVANCE NOTIFICATION**

<b>Closure type with height, weight, or width restrictions (available width, all lanes in one direction &lt; 16 feet)</b>	<b>MINIMUM NOTIFICATION</b>
Lane and shoulder closures	7 calendar days
Full roadway closures	7 calendar days
Ramp closures	7 calendar days
Detours	7 calendar days
<b>Closure type without height, weight, or width restrictions (available width, all lanes in one direction ≥ 16 feet)</b>	<b>MINIMUM NOTIFICATION</b>
Shoulder Closures	3 calendar days
Lane closures	3 business days
Ramp closures	3 business days
Modifying all closure types	3 business days

Discuss LCS completion dates and provide changes in the schedule to the engineer at weekly project meetings in order to manage closures nearing their completion date.

### Temporary Regulatory Speed Limit Reduction

Ensure that all traffic control signs for reducing the speed limit to 55 mph are in place prior to starting work operations. Post the speed reduction when one or two lanes of the roadway are closed for construction and workers are present and active in close proximity to the roadway or traffic is shifted onto the shoulder. Remove or cover the reduced speed limit signing when work is not in progress or all lanes are open to traffic.

During engineer-approved regulatory speed limit reductions, install temporary speed limit signs on the inside and outside shoulders of divided roadways to enhance visibility. When construction activities impede the location of a post-mounted regulatory speed limit sign, relocate the sign for maximum visibility to motorists. If work lasts less than 7 days, mount the regulatory speed limit sign on a portable sign support.

Coordinate with Regional Traffic Section to identify the construction stages that have approved temporary regulatory speed zones documented in a Temporary Speed Zone Declaration. Primary contact phone number: 262-521-5285, Dan Malicki.

Contact the Region Traffic Section at least 14-calendar days before installing the temporary speed zone. After installation of the temporary speed zone is complete, notify the Regional Traffic Section with field locations of temporary speed zones.

### Residential and Business Property Access

Maintain access to properties along CTH JJ and CTH T for local residents, businesses and emergency vehicles.

### Grade Differences

At locations that vehicular traffic and access will be maintained, provide temporary means to prevent grade differences between milled surfaces and existing or newly paved surfaces (both longitudinal and transverse) and temporary means to accommodate traffic across staged construction of concrete pavement. Bridge vertical differences using slopes of 12:1 or flatter through milling of existing HMA pavement, through temporary asphalt wedging, through the use of wedge/tapered joint as part of mainline HMA paving, or through other means as approved by the engineer.

## 6. Traffic Meeting and Traffic Control Scheduling.

Every Wednesday by 9:00 AM, submit a detailed proposed 2-week look-ahead traffic closure schedule to the engineer. Type the detailed proposed 2-week look-ahead closure schedule into an Excel spreadsheet provided by the engineer. Enter information such as closure dates, duration, work causing the closure and detours to be used. Also enter information such as ongoing long-term closures, emergency contacts and general 2-month look-ahead closure information into the Excel spreadsheet.

Meet with the engineer between 10:00 AM – 11:00 AM every Wednesday, or as scheduled by the engineer, to discuss and answer questions on the proposed schedule. Edit, delete, and add closures to the detailed proposed 2-week look-ahead schedule, as directed by the engineer, so that proposed closures meet specification requirements. Other edits, deletions, or additions unrelated to meeting specification requirements may also be agreed upon with the engineer during the 10:00 AM meeting.

Every Wednesday at 2:00 PM, or as scheduled by the engineer, attend a weekly traffic meeting. The meeting will bring local agencies, project stakeholders, owner managers, owner engineers, contractors, document control and construction engineering personnel together to discuss traffic staging, closures, and general impacts. Upon obtaining feedback from the meeting attendees, edit, delete, and add information to the detailed 2-week look-ahead closure schedule, as needed. Submit the revised 2-week look-ahead to the engineer.

## 7. Holiday and Special Event Work Restrictions.

Do not perform work on, nor haul materials of any kind along or across any portion of the highway carrying IH 94 or CTH T traffic, and entirely clear the traveled way and shoulders of such portions of the highway of equipment, barricades, signs, lights, and any other material that might impede the free flow of traffic during the following holiday and special event periods, unless otherwise specified below:

- From noon Friday, May 24, 2024 to 6:00 AM Tuesday, May 28, 2024 for Memorial Day;
- During other special events at American Family Field, restrictions will be defined during construction on an as needed basis as determined by the engineer;
- During Summerfest, June 20-22, June 27-29, and July 4-6, 2024, open park and ride lots to all parking spaces;
- From noon Wednesday, July 3, 2024 to 6:00 AM Monday, July 8, 2024 for Independence Day;
- During the Republican National Convention (RNC) no lane, ramp, park and ride, or full closures will be allowed between noon Friday, July 12, 2024 to 6:00 AM Monday, July 22, 2024 in both directions on IH 94. Do not begin 1060-10-71 Stage 2 contract work at CTH JJ before 6:00 AM Monday, July 22, 2024;
- During Wisconsin State Fair, August 1-11, 2024, open park and ride lots to all parking spaces;
- From noon Friday, August 30, 2024 to 6:00 AM Tuesday, September 3, 2024 for Labor Day;
- During Wisconsin Badger football games, maintain two open lanes on IH 94 from three hours prior to the game to three hours after the game;
- From noon Friday, November 22, 2024 to 6:00 AM Monday, November 25, 2024 for Deer Hunting Season;
- From noon Wednesday, November 27, 2024 to 6:00 AM Monday, December 2, 2024 for Thanksgiving Day;
- From noon Friday, December 20, 2024 to 6:00 AM Thursday, January 2, 2025 for Christmas and New Year's Day;
- From noon Friday, April 18, 2025 to 6:00 AM Monday, April 21, 2025 for Easter.

Holiday and special event work restrictions do not apply to roadways or ramps already closed long term during construction as shown on the plans. New long-term closures of ramps and roadways must be coordinated with the holiday and special event work restrictions.

stp-107-005 (20210113)

## 8. Utilities.

These contracts do come under the provision of Administrative Rule Trans 220.

Some of the utility work described below is dependent on prior work being performed by the contractor at a specific site. In such situations, provide the engineer and the affected utility a good faith notice of when the utility is to start work at the site. Provide this notice 14 to 16 calendar days in advance of when the prior work will be completed, and the site will be available to the utility owner. Follow-up with a confirmation notice to the engineer and the utility owner not less than three working days before the site will be ready for the utility owner to begin its work.

The utility work plan includes additional detailed information regarding the location of discontinued, relocated, or removed utility facilities. These can be requested during the bid preparation process or from the project engineer after the contract has been awarded and executed.

Known utilities on the projects are as follows:

### **Project 1060-10-71**

**The following utility companies have facilities within the project area; however, no adjustments are anticipated:**

**AT&T Local Network – Communications**

**AT&T Wisconsin – Communications**

**ATC Management – Electricity Transmission**

**City of Waukesha – Sewer**

**City of Waukesha – Water**

**Spectrum (Charter) – Communications**

**WE Energies – Electric**

**WE Energies – Gas**

### **Project 1060-47-70**

**AT&T Wisconsin – Communications Line** does have facilities within the project area. AT&T does not anticipate any conflicts with these facilities.

**ATC Management, Inc. – Electricity Transmission** does have facilities within the project area. ATC does not anticipate any conflicts with these facilities.

**CenturyLink – Communication Line** does have facilities within the project area. CenturyLink does not anticipate any conflicts with these facilities.

**City of Pewaukee Department of Public Works – Water** does have facilities within the project area. Pewaukee does not anticipate any conflicts with these facilities.

**Everstream – Communication Line** does have facilities within the project area. Everstream does not anticipate any conflicts with these facilities.

**Level 3 Communications LLC – Communication Line** does have facilities within the project area. Level 3 does not anticipate any conflicts with these facilities.

**Midwest Fiber Networks LLC – Communication Line** does have communication facilities within the project area. Midwest Fiber does not anticipate any conflicts with these facilities.

**Spectrum – Communication Line** does have facilities within the project area. Spectrum does not anticipate any conflicts with these facilities.

**Verizon Business – Communication Line** does have facilities within the project area. There is a fiber optic line crossing near the culvert replacement at Station 633+00 LT North of CTH DR (Golf RD). Verizon does not anticipate any conflicts with these facilities.

**Waukesha Water Utility – Water** does have facilities within the project area. Waukesha does not anticipate any conflicts with these facilities.

**We Energies – Electricity** does have facilities within the project area. We Energies does not anticipate any conflicts with these facilities.

We Energies electric has facilities within the construction limits. It is imperative that the highway contractor contact We Energies if removing any electrical underground cables, to verify that they have been discontinued and carry no electrical current. The contractor must not assume that unmarked facilities have been discontinued. At no time is it acceptable to push, pull, cut, or drill an unmarked facility without explicit consent from We Energies. Contractor must call the We Energies 24-hour Dispatch lines to arrange for this verification. We Energies Electric Dispatch, #1 (800) 662-4797

**We Energies – Gas/Petroleum** does have facilities within the project area. We Energies does not anticipate any conflicts with these facilities.

We Energies Gas has facilities within the construction limits. It is imperative that the highway contractor contact We Energies if removing any gas facilities, to verify that they have been discontinued and carry no natural gas. The contractor must not assume that unmarked facilities have been discontinued. At no time is it acceptable to push, pull, cut, or drill an unmarked facility without explicit consent from We Energies. Contractor must call the We Energies 24-hour Dispatch lines to arrange for this verification. We Energies Gas Dispatch #1 (800) 261-5325

### **Project 1330-47-71**

**ATC Management, Inc. – Electricity Transmission** does have facilities within the project area. ATC does not anticipate any conflicts with these facilities.

**CenturyLink – Communication Line** does have facilities within the project area. CenturyLink does not anticipate any conflicts with these facilities.

**Everstream – Communication Line** does have facilities within the project area. Everstream does not anticipate any conflicts with these facilities.

**Level 3 Communications LLC – Communication Line** does have facilities within the project area. Level 3 does not anticipate any conflicts with these facilities.

**Midwest Fiber Networks LLC – Communication Line** does have communication facilities within the project limits. Their existing fiber optic cable that runs along the southwest corner of the park & ride will be lowered by Midwest Fiber Networks LLC prior to the start of construction.

**Spectrum – Communication Line** does have facilities within the project area. Spectrum does not anticipate any conflicts with these facilities.

**We Energies – Electricity** does have facilities within the project area. We Energies does not anticipate any conflicts with these facilities.

We Energies electric has facilities within the construction limits. It is imperative that the highway contractor contact We Energies if removing any electrical underground cables, to verify that they have been discontinued and carry no electrical current. The contractor must not assume that unmarked facilities have been discontinued. At no time is it acceptable to push, pull, cut, or drill an unmarked facility without explicit consent from We Energies. Contractor must call the We Energies 24-hour Dispatch lines to arrange for this verification. We Energies Electric Dispatch #1 (800) 662-4797.

**We Energies – Gas/Petroleum** does have facilities within the project area. We Energies does not anticipate any conflicts with these facilities.

We Energies Gas has facilities within the construction limits. It is imperative that the highway contractor contact We Energies if removing any gas facilities, to verify that they have been discontinued and carry no natural gas. The contractor must not assume that unmarked facilities have been discontinued. At no time is it acceptable to push, pull, cut, or drill an unmarked facility without explicit consent from We Energies. Contractor must call the We Energies 24-hour Dispatch lines to arrange for this verification. We Energies Gas Dispatch #1 (800) 261-5325.

### **Project 2788-03-70**

**AT&T Wisconsin – Communications Line** does have facilities within the project area. AT&T does not anticipate any conflicts with these facilities.

**ATC Management, Inc. – Electricity Transmission** does have facilities within the project area. ATC does not anticipate any conflicts with these facilities.

**City of Pewaukee Department of Public Works – Water** does have facilities within the project area. Pewaukee does not anticipate any conflicts with these facilities.

**City of Waukesha – Sewer** does have facilities within the project area. Waukesha does not anticipate any conflicts with these facilities.

**Everstream – Communication Line** does have facilities within the project area. Everstream does not anticipate any conflicts with these facilities.

**Level 3 Communications LLC – Communication Line** does have facilities within the project area. Level 3 does not anticipate any conflicts with these facilities.

**Midwest Fiber Networks LLC – Communication Line** does have communication facilities within the project area. Midwest Fiber does not anticipate any conflicts with these facilities.

**Spectrum – Communication Line** does have facilities within the project area. Spectrum does not anticipate any conflicts with these facilities.

**Waukesha Water Utility – Water** does have facilities within the project area. Waukesha does not anticipate any conflicts with these facilities.

**We Energies – Electricity** does have facilities within the project area. We Energies does not anticipate any conflicts with these facilities.

We Energies Electric has facilities within the construction limits. It is imperative that the highway contractor contact We Energies if removing any electrical underground cables, to verify that they have been discontinued and carry no electrical current. The contractor must not assume that unmarked facilities have been discontinued. At no time is it acceptable to push, pull, cut, or drill an unmarked facility without explicit consent from We Energies. Contractor must call the We Energies 24-hour Dispatch lines to arrange for this verification. We Energies Electric Dispatch #1 (800) 662-4797.

**We Energies – Gas/Petroleum** does have facilities within the project area. We Energies does not anticipate any conflicts with these facilities.

We Energies Gas has facilities within the construction limits. It is imperative that the highway contractor contact We Energies if removing any gas facilities, to verify that they have been discontinued and carry no natural gas. The contractor must not assume that unmarked facilities have been discontinued. At no time is it acceptable to push, pull, cut, or drill an unmarked facility without explicit consent from We Energies. Contractor must call the We Energies 24-hour Dispatch lines to arrange for this verification. We Energies Gas Dispatch #1 (800) 261-5325.

## **9. Other Contracts.**

Modifications to the traffic control plan may be required by the engineer to be safe and consistent with adjacent work by others. Modifications will be considered incidental to this contract.

It is expected that routine maintenance by the city and county personnel may be required at certain times concurrently with the work being done under this contract.

The following contracts are anticipated to be under construction within the timeframe of this contract.

### **Project 2717-04-70**

C Waukesha Grandview Blvd

CTH T

Northview Rd to IH-94

WisDOT contact: Joseph Jelacic; (262) 548-6762; [Joseph.Jelacic@dot.wi.gov](mailto:Joseph.Jelacic@dot.wi.gov)

**Project 2025-07-73**

City & Vil Pewaukee, Capitol Dr

STH 190

STH 16 to .3 MI E of 5 Fields Rd

WisDOT contact: Nguyen Ly; (262) 548-8739; [Nguyen.Ly@dot.wi.gov](mailto:Nguyen.Ly@dot.wi.gov)

Coordinate activities, detours, work zone traffic control, roadway and lane closures, and other work items as required with other contracts.

**10. Hauling Restrictions.**

*Replace standard spec 107.2 with the following:*

Present to the department, five business days before proposed hauling, a proposed haul route plan detailing additional haul routes if additional haul routes are needed that are not part of the state trunk highway system. Include the months, days of the week, time of day, number of trucks, types of trucks and maximum loads of trucks anticipated to accomplish the project work in the additional haul route submittal.

The department will review the submittal and either approve or provide a letter with comments and proposed revisions to the contractor within five business days of its receipt. If approved, the department will subsequently survey the existing condition of that haul route to establish a baseline for assessing damage that the contractor's hauling operations might cause.

At all times, conduct operations in a manner that will cause a minimum of disruption to traffic on existing roadways.

sef-107-015 (20170310)

**11. Information to Bidders, WPDES Transportation Construction General Permit (TCGP) for Storm Water Discharges.**

The department has obtained permit coverage through the Wisconsin Department of Natural Resources to discharge storm water associated with land disturbing construction activities under this contract. Conform to all permit requirements for the project.

This permit is the Wisconsin Pollutant Discharge Elimination System, Transportation Construction General Permit, (WPDES Permit No. WI-S066796-2). The permit can be found at:

<https://widnr.widen.net/s/s5mwp2gd7s/finalsignedwisdotcsgp>

A certificate of permit coverage is available from the regional office by contacting Chris Zacharias at (414) 750-7955. Post the permit certificate in a conspicuous place at the construction site.

stp-107-056 (20230629)

**12. Environmental Protection, Aquatic Exotic Species Control.**

Exotic invasive organisms such as VHS, zebra mussels, purple loosestrife, and Eurasian water milfoil are becoming more prolific in Wisconsin and pose adverse effects to waters of the state. Wisconsin State Statutes 30.07, "Transportation of Aquatic Plants and Animals; Placement of Objects in Navigable Waters", details the state law that requires the removal of aquatic plants and zebra mussels each time equipment is put into state waters.

At construction sites that involve navigable water or wetlands, use the following cleaning procedures to minimize the chance of exotic invasive species infestation. Use these procedures for all equipment that comes in contact with waters of the state and/or infested water or potentially infested water in other states.

Ensure that all equipment that has been in contact with waters of the state, or with infested or potentially infested waters, has been decontaminated for aquatic plant materials and zebra mussels before being used in other waters of the state. Before using equipment on this project, thoroughly disinfect all equipment that has come into contact with potentially infested waters. Guidelines from the Wisconsin Department of Natural Resources for disinfection are available at:

<http://dnr.wi.gov/topic/invasives/disinfection.html>

Use the following inspection and removal procedures:

1. Before leaving the contaminated site, wash machinery and ensure that the machinery is free of all soil and other substances that could possibly contain exotic invasive species;
2. Drain all water from boats, trailers, bilges, live wells, coolers, bait buckets, engine compartments, and any other area where water may be trapped;
3. Inspect boat hulls, propellers, trailers and other surfaces. Scrape off any attached mussels, remove any aquatic plant materials (fragments, stems, leaves, seeds, or roots), and dispose of removed mussels and plant materials in a garbage can before leaving the area or invested waters; and
4. Disinfect your boat, equipment and gear by either:
  - 4.1. Washing with ~212 F water (steam clean), or
  - 4.2. Drying thoroughly for five days after cleaning with soap and water and/or high pressure water, or
  - 4.3. Disinfecting with either 200 ppm (0.5 oz per gallon or 1 Tablespoon per gallon) Chlorine for 10-minute contact time or 1:100 solution (38 grams per gallon) of Virkon Aquatic for 20- to 30-minute contact time. Note: Virkon is not registered to kill zebra mussel veligers nor invertebrates like spiny water flea. Therefore, this disinfect should be used in conjunction with a hot water (>104° F) application.

Complete the inspection and removal procedure before equipment is brought to the project site and before the equipment leaves the project site.

stp-107-055 (20130615)

### 13. Erosion Control.

*Supplement standard spec 107.20 with the following:*

Erosion control best management practices (BMPs) shown on the plans are at suggested locations. The actual locations will be determined by the contractor's ECIP and by the engineer. Include dust control and each dewatering or by-pass (mechanical pumping) operation in the ECIP submittal. The ECIP will supplement information shown on the plans and not reproduce it. The ECIP will identify how to implement the project's erosion control plan. ECIP will demonstrate timely and diligently staged operations, continuing all construction operations methodically from the initial removals and topsoil stripping operations through the subsequent grading, paving, re-application of top soil, and restoration of permanent vegetation to minimize the period of exposure to possible erosion.

Provide the ECIP 14 days prior to the pre-construction meeting. Provide 1 copy of the ECIP to the department and 1 copy of the ECIP to the WDNR Liaison Craig Webster, (262) 574-2141, [craig.webster@wisconsin.gov](mailto:craig.webster@wisconsin.gov). Do not implement the ECIP without department approval and perform all work conforming to the approved ECIP.

Maintain Erosion Control BMPs until permanent vegetation is established or until the engineer determines that the BMP is no longer required.

Stockpile excess materials or spoils on upland areas away from wetlands, floodplains, and waterways. Immediately install perimeter silt fence protection around stockpiles. If stockpiled materials will be left for more than 14 days, install temporary seed or other temporary erosion control measures the engineer orders.

Re-apply topsoil on graded areas, as the engineer directs, immediately after the grading is completed within those areas. Seed, fertilize, and mulch/erosion mat top-soiled areas, as the engineer directs, within 5 days after placement of topsoil. If graded areas are left not completed and exposed for more than 14 days, seed those areas with temporary seed and mulch.

#### **Dewatering (Mechanical Pumping) for Bypass Water (sediment-free) Operations**

If dewatering bypass operations are required from one pipe structure to another downstream pipe structure or from the upstream to downstream end of a culvert and the bypass flow is not transporting sediments (sand, silt, and clay particles) from a tributary work site area, bypass pumping operations will be allowed provided that the department has been made aware of and approves operation. When pumping bypass flows, the discharge location will need to be stable and not produce any erosion from the discharge velocity that would cause release of sediment downstream. Dewatering is considered incidental to the contract.



## Dewatering (Mechanical Pumping) for Treatment Water (sediment-laden) Operations

If dewatering operations require pumping of water containing sediments (sand, silt, and clay particles), the discharge will not be allowed to leave the work site or discharge to a storm water conveyance system without sediment removal treatment. Do not allow any excavation for; structures, utilities, grading, maintaining drainage that requires dewatering (mechanical pumping) of water containing sediments (sand, silt, and clay particles) to leave the work site or discharge to a storm water conveyance system without sediment removal treatment.

Prior to each dewatering operation, submit to the department a separate ECIP amendment for sediment removal. Guidance on dewatering can be found on the Wisconsin DNR website located in the Storm Water Construction Technical Standards, Dewatering Code #1061,

[http://dnr.wi.gov/topic/stormwater/standards/const\\_standards.html](http://dnr.wi.gov/topic/stormwater/standards/const_standards.html).

Include reasoning, location, and schedule duration proposed for each operation. Per Code 1061, include all selection criteria: site assessment, dewatering practice selection, calculations, plans, specifications, operations, maintenance, and location of proposed treated water discharge. Provide a stabilized discharge area. If directing discharge towards or into an inlet structure, provide additional inlet protection for back-up protection. Dewatering is considered incidental to the contract.

## Maintaining Drainage

Maintain drainage at and through worksite during construction conforming to standard spec 107.20, 204.3.2.1(3), 205.3.3 and 520.3.1(2). Use existing storm sewers, existing culvert pipes, existing drainage channels, temporary culvert pipes, or temporary drainage channels to maintain existing surface and pipe drainage. Pumps may be required to drain the surface, pipe, and structure discharges during construction. Costs for furnishing, operating, and maintaining the pumps is considered incidental to the contract.

SER-107-003 (20161220)

## 14. Temporary Wetland Impacts.

Temporary impacts to delineated wetlands are anticipated for the work in the median at S-67-420, around the inflow pipe replacement at C-67-0865, and at Station 633+00 for the culvert replacement. Provide appropriate BMPs and schedule work operations to avoid or minimize impacts. Restore the areas to the original sections existing before grading.

## 15. Notice to Contractor – Airport Operating Restrictions.

The FAA Notice Criteria Tool was completed for all of the light poles, traffic signals, sign poles and the traffic camera pole during the design phase. An inventory of that coordination is as follows:

Pole #	Station	Offset	Elevation	Pole Type	FAA Case Number
101	128+53.2	108.1 LT	928	Lighting	2022-AGL-237-OE
202	128+64.1	50.8' LT	909	Signal	2022-AGL-238-OE
203	129+00.0	0.0' RT	929	Lighting	2022-AGL-239-OE
104	129+21.4	60.4' RT	915	Signal	2017-AGL-11132-OE (NO SIGNAL IN THIS QUADRANT)
105	128+46.5	53.4' RT	909	Signal	2022-AGL-240-OE
106	127+94.9	80.6' LT	910	Lighting	2017-AGL-11134-OE (NO LIGHTING IN THIS QUADRANT)
207	127+97.3	64.8' LT	919	Signal	2022-AGL-241-OE
208	127+54.6	10.0' LT	931	Lighting	2022-AGL-244-OE
109	127+61.0	54.1' RT	912	Signal	2022-AGL-242-OE

Pole #	Station	Offset	Elevation	Pole Type	FAA Case Number
110	126+37.6	6.6' LT	920	Sign	2022-AGL-243-OE
111	125+90.1	51.8' LT	925	Lighting	2022-AGL-15203-OE
112	125+90.6	51.9' RT	925	Lighting	2022-AGL-15204-OE
113	124+18.6	51.9' LT	925	Lighting	2022-AGL-15205-OE
114	124+19.9	51.7' RT	925	Lighting	2022-AGL-15206-OE
115	123+65.0	6.6' RT	919	Sign	2022-AGL-228-OE
216	123+75.5	59.7' RT	945	Camera	2022-AGL-245-OE
117	122+95.2	54.2' LT	908	Signal	2022-AGL-229-OE
118	123+07.8	13.4' RT	927	Lighting	2022-AGL-14113-OE
219	122+76.5	58.4' RT	924	Signal	2023-AGL-20464-OE
120	122+06.5	55.1' LT	906	Signal	2022-AGL-232-OE
121	121+27.6	57.0' LT	923	Signal	2017-AGL-11149-OE (NO SIGNAL IN THIS QUADRANT)
222	121+54.8	0' LT	923	Lighting	2022-AGL-14115-OE
123	121+94.9	50.1' RT	906	Signal	2022-AGL-234-OE
124	122+21.4	131.1' RT	921	Lighting	2022-AGL-235-OE
125	123+15.6	275.4' RT	915	Lighting	2022-AGL-236-OE
301	126+40.2	59.6' LT	925	Camera	2022-AGL-14118-OE
302	121+84.3	90.9' RT	933	Ramp Gate	2022-AGL-14116-OE

Fill out the FAA Notice Criteria tool for all permanent structures (bridge, light pole, etc.) or equipment (crane, etc.) used during construction.

<https://oeaaa.faa.gov/oeaaa/external/portal.jsp>

If required by the Notice Criteria tool, and for all crane or construction equipment higher than 15 feet above the ground, submit completed form 7460-1 (Notice of Proposed Construction or Alteration) to the Federal Aviation Administration (FAA) at least 45 days before starting construction.

Contact Joshua Cothren, (608) 266-6812, WisBOA airport operations and airspace safety program manager, for assistance submitting forms.

CTH T is at the end of a critical path to the airport, and CTH JJ is close to the approach path to another runway.

Crane heights should be kept as low as possible and be flagged at all times according to FAA standards.

Cranes shall be lowered at night so that the highest point of any part of the crane does not exceed a height greater than 30 feet from the ground.

Crane operation is prohibited from a half hour before dusk to a half hour after dawn.

No upward facing lights at night.

All vehicles need to have red lights on them or the rotating lights.

Notify the Waukesha County Airport 3 days in advance of closing ramps at CTH T and WIS 164.

sef-107-020 (20180718)

**16. Notice to Contractor – Notification of Demolition and/or Renovation No Asbestos Found.**

John Roelke, License Number All-119523, inspected Structure B-67-0240 and B-67-245 for asbestos on September 2, 2014. No Regulated Asbestos Containing Material (RACM) was found on this structure. A copy of the inspection report is included with the bid package or available from Andrew Malsom, (262) 548-6705, [andrew.malsom@dot.wi.gov](mailto:andrew.malsom@dot.wi.gov).

According to NR447 and DHS159, ensure that DNR or DHS receives a completed Notification of Demolition and/or Renovation (DNR Form 4500-113 (R 03/20), or subsequent revision) via U.S. mail, hand-delivery, or using the online notification system at least 10 working days before beginning any construction or demolition. Pay all associated fees. Provide a copy of the completed 4500-113 form to Andrew Malsom, (262) 548-6705, [andrew.malsom@dot.wi.gov](mailto:andrew.malsom@dot.wi.gov) and via e-mail to [dothazmatunit@dot.wi.gov](mailto:dothazmatunit@dot.wi.gov) or via U.S. mail to DOT BTS-ESS attn: Hazardous Materials Specialist, 5 South S.513.12, PO Box 7965, Madison, WI 53707-7965. In addition, comply with all local or municipal asbestos requirements.

Use the following information to complete WisDNR form 4500-113:

- Site Name: Structure B-67-0240 CTH JJ over IH 94, Structure B-67-0245 CTH T over IH 94
- Site Address: B67-0240 0.7 Mile W Jct CTH J, B67-0245 0.3 Mile North JCT CTH TJ/Silvermail Rd
- Ownership Information: WisDOT Transportation SE Region 141 NW Barstow Street P.O. Box 798, Waukesha, WI 53187
- Contact: Andrew Malsom
- Phone: (262) 548-6705
- Age: B-67-0240 29 years old. This structure was constructed in 1994, B67-0245 27 years old. This structure was constructed in 1995.
- Area: B-67-0240 14499 SF of deck, B-67-0245 21600 SF of deck

Insert the following paragraph in Section 6.g.:

If asbestos not previously identified is found or previously non-friable asbestos becomes crumbled, pulverized, or reduced to a powder, stop work immediately, notify the engineer, and the engineer will notify the department's Bureau of Technical Services at (608) 266-1476 for an emergency response as specified in standard spec 107.24. Keep material wet until it is abated or until it is determined to be non-asbestos containing material.

stp-107-125 (20220628)

**17. Notice to Contractor – Traffic Signal, Lighting, FTMS, and Sign Structure Equipment Lead Time.**

Order traffic signal, lighting, FTMS, and sign structure equipment as soon as possible to assure the equipment is procured in a timely fashion and, therefore, installed, inspected, and ready for turn-on at the required date.

**18. Notice to Contractor – Wisconsin Coach Lines/Coach USA.**

Wisconsin Coach Lines/Coach USA operates bus routes within the construction limits for the Nagawaukee and Meadowbrook Park and Ride lots. Invite Wisconsin Coach Lines/Coach USA to all coordination meetings between the contractor, the department, local officials and business people to discuss the project schedule of operations including vehicular and pedestrian access during construction operations.

Notify Wisconsin Coach Lines/Coach USA at least 10 business days prior to beginning work. If necessary, Wisconsin Coach Lines/Coach USA will remove their existing bus stop signs before work begins and re-install or replace bus stop signs before new pavement opens to vehicular traffic. The contractor shall provide temporary bus stops with ADA compliant pedestrian accommodations, to be paid under separate bid items. Temporary bus stops must be connected to the sidewalk network when one is available. Wisconsin Coach Lines/Coach USA will provide temporary bus stop signs.

The Wisconsin Coach Lines contacts are:

Tom Dieckelman  
President  
1520 Arcadian Ave  
Waukesha, WI 53186  
Phone: (262) 542-8861  
[tom.dieckelman@coachusa.com](mailto:tom.dieckelman@coachusa.com)

Lori Sagert  
Operations Manager  
1520 Arcadian Ave  
Waukesha, WI 53186  
Phone: (262) 542-8861  
[lori.sagert@coachusa.com](mailto:lori.sagert@coachusa.com)

## 19. Notice to Contractor – Waukesha Metro.

The Waukesha Metro operates the following bus routes within the construction limits: Route 9. Invite Waukesha Metro to all coordination meetings between the contractor, the department, local officials and business people to discuss the project schedule of operations including vehicular and pedestrian access during construction operations.

Notify Waukesha Metro at least 10 business days prior to beginning work. If necessary, Waukesha Metro will remove their existing bus stop signs and shelters before work begins and re-install or replace bus stop signs and shelters before new pavement opens to vehicular traffic. The contractor shall provide temporary bus stops with ADA compliant pedestrian accommodations, to be paid under separate bid items. Temporary bus stops must be connected to the sidewalk network when one is available. Waukesha Metro will provide temporary bus stop signs.

The Waukesha Metro contact:

Brian Engelking  
Transit Manager  
Waukesha Metro  
2311 Badger Drive  
Waukesha, WI 53188  
Phone: (262) 524-3634  
[bengelki@waukesha-wi.gov](mailto:bengelki@waukesha-wi.gov)

SER-107-009 (20220323)

## 20. Contractor Document Submittals.

This special provision describes minimum requirements for submitting project documents to the department. This special provision does not apply to shop drawing submittals.

Provide one electronic copy of all documents requiring department review, acceptance, or approval. Attach a completed engineer-provided transmittal sheet to each email submittal. The department will reject submittals with incomplete transmittal sheets and require re-submittal.

The department will return one reviewed, accepted, or approved original to the contractor. Additional return originals can be requested. Submit an additional original for each additional return original requested.

Submit electronic copies in PDF format via email to accounts the engineer determines. If possible, create PDFs from original documents in their native format (e.g., Word, Excel, AutoCAD, etc.). Scan other documents to PDF format with a minimum resolution of 600 dpi.

All costs for contractor document submittals are incidental to the contract.

sef-105-010 (20150619)

## **21. Nighttime Work Lighting-Stationary.**

### **A Description**

This special provision describes furnishing portable lighting as necessary to complete nighttime work. Nighttime operations consist of work specifically scheduled to occur after sunset and before sunrise.

### **B (Vacant)**

### **C Construction**

#### **C.1 General**

This provision shall apply when providing, maintaining, moving, and removing portable light towers and equipment-mounted lighting fixtures for nighttime stationary work operations, for the duration of nighttime work on the contract.

At least 14 days before the nighttime work, furnish a lighting plan to the engineer for review and acceptance. Address the following in the plan:

1. Layout, including location of portable lighting – lateral placement, height, and spacing. Clearly show on the layout the location of all lights necessary for every aspect of work to be done at night.
2. Specifications, brochures, and technical data of all lighting equipment to be used.
3. The details on how the luminaires will be attached.
4. Electrical power source information.
5. Details on the louvers, shields, or methods to be employed to reduce glare.
6. Lighting calculations. Provide illumination with average to minimum uniformity ratio of 5:1 or less throughout the work area.
7. Detail information on any other auxiliary equipment.

#### **C.2 Portable Lighting**

Provide portable lighting that is sturdy and free standing and does not require any guy wires, braces, or any other attachments. Furnish portable lighting capable of being moved as necessary to keep up with the construction project. Position the portable lighting and trailers to minimize the risk of being impacted by traffic on the roadway or by construction traffic or equipment. Provide lightning protection for the portable lighting. Portable lighting shall withstand up to 60 mph wind velocity.

If portable generators are used as a power source, furnish adequate power to operate all required lighting equipment without any interruption during the nighttime work. Provide wiring that is weatherproof and installed according to local, state, federal (NECA and OSHA) requirements. Equip all power sources with a ground-fault circuit interrupter to prevent electrical shock.

#### **C.3 Light Level and Uniformity**

Position (spacing and mounting height) the luminaires to provide illumination with an average to minimum uniformity ratio of 5:1 or less throughout the work area.

Illuminate the area as necessary to incorporate construction vehicles, equipment, and personnel activities.

#### **C.4 Glare Control**

Design, install, and operate all lighting supplied under these specifications to minimize or avoid glare that interferes with all traffic on the roadway or that causes annoyance or discomfort for properties adjoining the roadway. Locate, aim, and adjust the luminaires to provide the adequate level of illumination and the specified uniformity in the work area without the creation of objectionable glare.

Provide louvers, shields, or visors, as needed, to reduce any objectionable levels of glare. As a minimum, ensure the following requirements are met to avoid objectionable glare on the roadways open to traffic in either direction or for adjoining properties:

1. Aim tower-mounted luminaires, either parallel or perpendicular to the roadway, so as to minimize light aimed toward approaching traffic.
2. Aim all luminaires such that the center of beam axis is no greater than 60 degrees above vertical (straight down).

If lighting does not meet above-mentioned criteria, adjust the lighting within 24 hours.

### **C.5 Continuous Operation**

Provide and have available sufficient fuel, spare lamps, generators, and qualified personnel to ensure that the lights will operate continuously during nighttime operation. In the event of any failure of the lighting system, discontinue the operation until the adequate level of illumination is restored. Move and remove lighting as necessary.

#### **D (Vacant)**

#### **E Payment**

Costs for furnishing a lighting plan, and for providing, maintaining, moving, and removing portable lighting, tower mounted lighting, and equipment-mounted lighting required under this special provision are incidental to the contract.

stp-643-010 (20100709)

## **22. Material Stockpile and Equipment Storage.**

Submit a map showing all proposed material stockpile and equipment storage locations to the engineer 14 calendar days before either the preconstruction conference or proposed use, whichever comes first. Identify the purpose; length, width, and height; and duration of material stockpile or equipment storage at each location. Do not stockpile material or store equipment until the engineer approves.

Material stockpiles and equipment storage south of IH 94 ramp terminals on CTH T are limited to a height of 5 feet and a duration of 14 calendar days unless the engineer approves otherwise in writing.

SER-107-011 (20220412)

## **23. Available Documents.**

The department will make its information available to bidding contractors. The list of documents that are available for contractors' information includes:

- Design Study Report
- Environmental Document
- As-Built Drawings
- Preconstruction survey
- Traffic Management Plan

These documents are available from Chris Zacharias at 141 NW Barstow Street, Waukesha, WI 53187 at [christopher.zacharias@dot.wi.gov](mailto:christopher.zacharias@dot.wi.gov), or (414) 750-7955.

Reproduction costs will be applied to all copies requested.

sef-102-005 (20170310)

## **24. Removing Concrete Surface Partial Depth, Item 204.0109.S.**

### **A Description**

This special provision describes removing a portion of concrete surfaces as the plans show and conforming to standard spec 204.

### **B (Vacant)**

### **C Construction**

#### **C.1 Equipment**

Use a machine that provides a surface finish acceptable to the engineer. Shroud the machine to prevent discharge of any loosened material into adjacent work areas or live traffic lanes.

Use a machine that is equipped with electronic devices that provide accurate depth, grade and slope control, and acceptable dust control system.

## C.2 Methods

Remove existing concrete to the depths as shown on the plan by grinding, planing, chipping, sawing, milling, or by using other methods approved by the engineer.

Perform the removal operation in such a manner as to preclude damage to the remaining pavement and results in a reasonable uniform plane surface free of excessive large scarification marks and having a uniform transverse slope.

The sequence of removal operations shall be such that no exposed longitudinal joints 2 inches or more in depth remain during non-working hours. Windrowing or storing of the removed material on the roadway will only be permitted in conjunction with a continuous removal and pick-up operation. During non-working hours, clear the roadway of all materials and equipment.

Removed pavement becomes the property of the contractor. Properly dispose of it as specified in standard spec 204.3.1.3.

## D Measurement

The department will measure Removing Concrete Surface Partial Depth in area by the square foot of surface area removed.

## E Payment

The department will pay for measured quantities at the contract unit price under the following bid item:

ITEM NUMBER	DESCRIPTION	UNIT
204.0109.S	Removing Concrete Surface Partial Depth	SF

Payment is full compensation for removing the concrete; and for disposing of materials.

stp-204-041 (20080902)

## 25. Removing Asphaltic Longitudinal Notched Wedge Joint Milling, Item 204.0126.S.

### A Description

This special provision describes the milling and removing of the upper layer HMA longitudinal notched wedge joint, including sweeping and cleaning of the affected area prior to paving the adjacent lane. Follow drop-off and hazard protection in standard spec 104.6.1.2.3.

### B (Vacant)

### C Construction

Prior to paving the adjacent upper layer HMA lane, mill longitudinal notched wedge joint to a true line with a face perpendicular to the surface of the existing asphaltic surface pavement as the plans show or the engineer directs. Provide a uniform milled surface that is reasonably plane, free of excessively large scarification marks, and has the grade and transverse slope the plans show, or the engineer directs. Do not damage the remaining pavement.

Use a self-propelled milling machine with depth, grade, and slope controls. Shroud the drum to prevent discharging loosened material onto the adjacent work areas or live traffic lanes. Provide an engineer-approved dust control system.

Thoroughly clean the milled surface and completely remove all millings from the project site. Unless using a continuous removal and pick-up operation, do not windrow or store material on the roadway. Clear the roadway of all material and equipment during non-working hours. The contractor becomes the owner of the removed asphaltic pavement and is responsible for the disposal as specified in standard spec 204.3.1.3.

### D Measurement

The department will measure Removing Asphaltic Longitudinal Notched Wedge Joint Milling by the linear foot unit for all wedge joints, acceptably removed.

### E Payment

The department will pay for measured quantities at the contract unit price under the following bid item:

ITEM NUMBER	DESCRIPTION	UNIT
204.0126.S	Removing Asphaltic Longitudinal Notched Wedge Joint Milling	LF

Payment is full compensation for milling, removing, sweeping, cleaning, and disposing of materials.

stp-204-045 (20191121)

**26. Removing Crash Cushion, Item 204.9060.S.001.**

**A Description**

This special provision describes removing crash cushion conforming to standard spec 204.

**B (Vacant)**

**C (Vacant)**

**D Measurement**

The department will measure Removing Crash Cushion as each individual crash cushion, acceptably completed.

**E Payment**

*Add the following to standard spec 204.5:*

ITEM NUMBER	DESCRIPTION	UNIT
204.9060.S.001	Removing Crash Cushion	EACH

stp-204-025 (20230113)

**27. Removing Bicycle Rack, Item 204.9060.S.002.**

**A Description**

This special provision describes removing bicycle rack conforming to standard spec 204.

**B (Vacant)**

**C (Vacant)**

**D Measurement**

The department will measure Removing Bicycle Rack as each individual bicycle rack, acceptably completed.

**E Payment**

*Add the following to standard spec 204.5:*

ITEM NUMBER	DESCRIPTION	UNIT
204.9060.S.002	Removing Bicycle Rack	EACH

stp-204-025 (20230113)

**28. Removing Existing Ramp Gate Assembly, Item 204.9060.S.003.**

**A Description**

This special provision describes removing Existing Ramp Gate Assembly conforming to standard spec 204.

**B Materials**

All removed material shall become the property of the contractor and be disposed of off the project site.

**C Construction**

Removing existing ramp gate assembly consists of removing the ramp gate pole, arm, solar panel pole, solar panel, pole mounted cabinet, wire and associated hardware and appurtenances. Concrete bases and conduit may be left in place.



## D Measurement

The department will measure Removing Existing Ramp Gate Assembly in each unit removed, acceptably completed.

## E Payment

Add the following to standard spec 204.5:

ITEM NUMBER	DESCRIPTION	UNIT
204.9060.S.003	Removing Existing Ramp Gate Assembly	EACH
stp-204-025 (20230113)		

- 29. Removing Traffic Signals IH 94 EB Ramps & CTH SS, Item 204.9060.S.021;  
Removing Traffic Signals STH 318 & Silvernail Road, Item 204.9060.S.041;  
Removing Traffic Signals IH 94 EB Ramps & STH 318, Item 204.9060.S.051;  
Removing Traffic Signals IH 94 WB Ramps & STH 318, Item 204.9060.S.061;  
Removing Traffic Signals IH 94 EB Ramps & CTH T, Item 204.9060.S.071;  
Removing Traffic Signals IH 94 WB Ramps & CTH T, Item 204.9060.S.081.**

## A Description

This special provision describes removing existing traffic signals at the intersections of IH 94 EB Ramps & CTH SS, STH 318 & Silvernail Rd, IH 94 EB Ramps & STH 318, IH 94 WB Ramps & STH 318, IH 94 EB Ramps & CTH T, and IH 94 WB Ramps & CTH T according to the pertinent provisions of standard spec 204 and as hereinafter provided. Specific removal items are noted in the plans.

## B (Vacant)

## C Construction

Arrange for the de-energizing of the traffic signals with the local electrical utility after receiving approval from the engineer that the existing traffic signals can be removed.

Notify the department's Electrical Field Unit at (414) 266-1170 at least five working days prior to the removal of the traffic signals. Complete the removal work as soon as possible following shut down of this equipment.

The department assumes that all equipment is in good condition and in working order prior to the contractor's removal operation. Prior to removal, inspect and provide a list of any damaged or non-working traffic signal equipment to the engineer. Any equipment not identified as damaged or not working, prior to removal, will be replaced by the contractor at no cost to the department.

Remove all standards and poles per plan from their concrete footings and disassemble out of traffic. Remove the transformer bases from each pole. Remove the signal heads, emergency vehicle preemption heads (evp), mast arms, luminaires, wiring/cabling, and traffic signal mounting devices from each signal standard, arm, or pole. Ensure that all access hand hole doors and all associated hardware remain intact. Dispose of the underground signal cable, internal wires, and street lighting cable off the state right-of-way. Deliver the remaining materials, except for traffic signal LED and luminaire lamp, switch, and ballasts to the West Allis Electrical Service Facility at 935 South 60th Street, West Allis, Milwaukee County. Contact the department's Electrical Field Unit at (414) 266-1170 at least five working days prior to delivery to make arrangements. Traffic signal LED and luminaire lamp, switch, and ballast disposal shall be paid for as a separate item.

DOT forces shall remove the signal cabinet from the footing. The signal cabinet and associated signal cabinet equipment will be removed from the site by DOT forces and will remain the property of the department.

## D Measurement

The department will measure Removing Traffic Signals as each individual unit, acceptably completed.

## E Payment

The department will pay for measured quantities at the contract unit price under the following bid items:

ITEM NUMBER	DESCRIPTION	UNIT
204.9060.S.021	Removing Traffic Signals IH 94 EB Ramps & CTH SS	EACH
204.9060.S.041	Removing Traffic Signals STH 318 & Silvernail Rd	EACH
204.9060.S.051	Removing Traffic Signals IH 94 EB Ramps & STH 318	EACH
204.9060.S.061	Removing Traffic Signals IH 94 WB Ramps & STH 318	EACH
204.9060.S.071	Removing Traffic Signals IH 94 EB Ramps & CTH T	EACH
204.9060.S.081	Removing Traffic Signals IH 94 WB Ramps & CTH T	EACH

Payment is full compensation for removing, disassembling traffic signals, scrapping of some materials, disposing of scrap material, for delivering the requested materials to the department, and incidentals necessary to complete the contract work.

The department will pay separately for the detachment and disposal of luminaires and lamps under the item Lamp, Ballast, LED, Switch Disposal by Contractor.

- 30. Removing Loop Detector Wire and Lead-In Cable STH 318 & Silvernail Road, Item 204.9060.S.042;  
Removing Loop Detector Wire and Lead-In Cable IH 94 EB Ramps & STH 318, Item 204.9060.S.052;  
Removing Loop Detector Wire and Lead-In Cable IH 94 WB Ramps & STH 318, Item 204.9060.S.062;  
Removing Loop Detector Wire and Lead-In Cable IH 94 EB Ramps & CTH T, Item 204.9060.S.072;  
Removing Loop Detector Wire and Lead-In Cable IH 94 WB Ramps & CTH T, Item 204.9060.S.082.**

### A Description

This special provision describes removing loop detector wire and lead-in cable at the intersections of STH 318 & Silvernail Rd, IH 94 EB Ramps & STH 318, IH 94 WB Ramps & STH 318, IH 94 EB Ramps & CTH T, and IH 94 WB Ramps & CTH T. Removal will be according to standard spec 204, as shown in the plans, and as hereinafter provided.

### B (Vacant)

### C Construction

Notify the department's Electrical Field Unit at (414) 266-1170 at least five working days prior to the removal of the loop detector wire and lead-in cable.

Remove and dispose of detector lead-in cable including loop wire for abandoned loops off the right-of-way.

### D Measurement

The department will measure Removing Loop Detector Wire and Lead-In Cable as each individual unit, acceptably completed.

## E Payment

The department will pay for measured quantities at the contract unit price under the following bid items:

ITEM NUMBER	DESCRIPTION	UNIT
204.9060.S.042	Removing Loop Detector Wire and Lead-In Cable STH 318 & Silvernail Rd	EACH
204.9060.S.052	Removing Loop Detector Wire and Lead-In Cable IH 94 EB Ramps & STH 318	EACH
204.9060.S.062	Removing Loop Detector Wire and Lead-In Cable IH 94 WB Ramps & STH 318	EACH
204.9060.S.072	Removing Loop Detector Wire and Lead-In Cable IH 94 EB Ramps & CTH T	EACH
204.9060.S.082	Removing Loop Detector Wire and Lead-In Cable IH 94 WB Ramps & CTH T	EACH

Payment is full compensation for removing, scrapping, and disposing of material and incidentals necessary to complete the contract work.

**31. Removing Lighting Units, Item 204.9060.S.401.**

**A Description**

This special provision describes removing lighting units as the plans show, conforming to standard spec 204, and as follows.

**B Materials**

All removed material shall become the property of the contractor and be disposed of off the project site, except for LED and HPS light fixtures and bulbs. LED and HPS light fixtures and bulbs are considered hazardous material. Disposal shall be done by the contractor utilizing STSP 659-500 Lamp, Ballast, LED, Switch Disposal by Contractor.

**C Construction**

Remove lighting units consisting of pole, arm, luminaire, lamp, wires, breakaway device, and associated hardware and appurtenances.

No removal work will be permitted without approval from the engineer. Removal shall start as soon as the temporary lighting or permanent lighting, as applicable, is placed in approved operation. An inspection and approval by the engineer will take place before any associated proposed permanent or temporary lighting is approved for operation.

**D Measurement**

The department will measure Removing Lighting Units by each individual unit removed, acceptably completed.

**E Payment**

*Add the following to standard spec 204.5:*

ITEM NUMBER	DESCRIPTION	UNIT
204.9060.S.401	Removing Lighting Units	EACH
SER-204.15 (20220214)		

**32. Removing luminaires, Item 204.9060.S.402.**

**A Description**

This special provision describes removing existing luminaires, airport obstruction lights, and lamps from light poles, high mast tower or bridge decks as shown on the plans, according to the pertinent provisions of standard spec 204, and as hereinafter provided. Light poles, high mast towers or bridge deck shall remain in service.

**B Materials**

Removed luminaires, airport obstruction lights, and lamps become the property of the contractor and shall be disposed of off the project site, except for LED and HPS light fixtures and bulbs. LED and HPS light fixtures and bulbs are considered hazardous material. Disposal shall be done by the contractor utilizing STSP 659-500 Lamp, Ballast, LED, Switch Disposal by Contractor.

**C Construction**

No removal work will be permitted without approval from the engineer. Removal shall start as soon as the temporary lighting or permanent lighting, as applicable, is placed in approved operation. An inspection and approval by the engineer will take place before any associated proposed permanent or temporary lighting is approved for operation.

**D Measurement**

The department will measure Removing Luminaires by each individual unit, acceptably completed.

## E Payment

Add the following to standard spec 204.5:

ITEM NUMBER	DESCRIPTION	UNIT
204.9060.S.402	Removing Luminaires	EACH
SER-204.11 (20171021)		

### 33. Removing Cable Barrier, Item 204.9090.S.001.

#### A Description

This special provision describes removing cable barrier conforming to standard spec 204.

#### B (Vacant)

#### C (Vacant)

#### D Measurement

The department will measure Removing Cable Barrier by the linear foot, acceptably completed.

## E Payment

Add the following to standard spec 204.5:

ITEM NUMBER	DESCRIPTION	UNIT
204.9090.S.001	Removing Cable Barrier	LF
stp-204-025 (20230113)		

### 34. QMP HMA Pavement Nuclear Density.

#### A Description

Replace standard spec 460.3.3.2 (1) and standard spec 460.3.3.2 (4) with the following:

- (1) This special provision describes density testing of in-place HMA pavement with the use of nuclear density gauges. Conform to standard spec 460 except as modified in this special provision.
- (2) Provide and maintain a quality control program defined as all activities and documentation of the following:
  1. Selection of test sites.
  2. Testing.
  3. Necessary adjustments in the process.
  4. Process control inspection.
- (3) Chapter 8 of the department's construction and materials manual (CMM) provides additional detailed guidance for QMP work and describes required procedures.

<https://wisconsindot.gov/rdwy/cmm/cm-08-00.pdf>

- (4) The department's Materials Reporting System (MRS) software allows contractors to submit data to the department electronically, estimate pay adjustments, and print selected reports. Qualified personnel may obtain MRS software from the department's web site at:

<http://www.atwoodsystems.com/>

## B Materials

### B.1 Personnel

- (1) Nuclear gauge owners and personnel using nuclear gauges shall comply with WisDOT requirements according to 460.3.3 and CMM 815.

### B.2 Testing

- (1) Conform to WTM T355 and CMM 815 for density testing and gauge monitoring methods. Conform to CMM 815.10.4 for test duration and gauge placement.

## **B.3 Equipment**

### **B.3.1 General**

- (1) Furnish nuclear gauges according to CMM 815.2.
- (2) Furnish nuclear gauges from the department's approved product list at <https://wisconsindot.gov/Pages/doing-bus/eng-consultants/cnslt-rsrcs/tools/appr-prod/default.aspx>

### **B.3.2 Comparison of Nuclear Gauges**

#### **B.3.2.1 Comparison of QC and QV Nuclear Gauges**

- (1) Compare QC and QV nuclear gauges according to WTM T355.

#### **B.3.2.2 Reference Site Monitoring**

- (1) Conduct reference site monitoring for both QC and QV gauges according to WTM T355.

## **B.4 Quality Control Testing and Documentation**

### **B.4.1 Lot and Sublot Requirements**

#### **B.4.1.1 Mainline Traffic Lanes, Shoulders, and Appurtenances**

- (1) Divide the pavement into lots and sublots for nuclear density testing according to CMM 815.10.2.
- (2) Determine required number of tests according to CMM 815.10.2.1.
- (3) Determine random testing locations according to CMM 815.10.3.

#### **B.4.1.2 Side Roads, Crossovers, Turn Lanes, Ramps, and Roundabouts**

- (1) Divide the pavement into lots and sublots for nuclear density testing according to CMM 815.10.2.
- (2) Determine required number of tests according to CMM 815.10.2.2.
- (3) Determine random testing locations according to CMM 815.10.3.

### **B.4.2 Pavement Density Determination**

#### **B.4.2.1 Mainline Traffic Lanes and Appurtenances**

- (1) Calculate the average sublot densities using the individual test results in each sublot.
- (2) If all sublot averages are no more than one percent below the target density, calculate the daily lot density by averaging the results of each random QC test taken on that day's material.
- (3) If any sublot average is more than one percent below the target density, do not include the individual test results from that sublot when computing the lot average density and remove that sublot's tonnage from the daily quantity for incentive. The tonnage from any such sublot is subject to disincentive pay as specified in standard spec 460.5.2.2.

#### **B.4.2.2 Mainline Shoulders**

##### **B.4.2.2.1 Width Greater Than 5 Feet**

- (1) Determine the pavement density as specified in B.4.2.1.

##### **B.4.2.2.2 Width of 5 Feet or Less**

- (1) If all sublot test results are no more than 3.0 percent below the minimum target density, calculate the daily lot density by averaging all individual test results for the day.
- (2) If a sublot test result is more than 3.0 percent below the target density, the engineer may require the unacceptable material to be removed and replaced with acceptable material or allow the nonconforming material to remain in place with a 50 percent pay reduction. Determine the limits of the unacceptable material according to B.4.3.

##### **B.4.2.3 Side Roads, Crossovers, Turn Lanes, Ramps, and Roundabouts**

- (1) Determine the pavement density as specified in B.4.2.1.

#### **B.4.2.4 Documentation**

- (1) Document QC density test data as specified in CMM 815. Provide the engineer with the data for each lot within 24 hours of completing the QC testing for the lot.

### **B.4.3 Corrective Action**

- (1) Notify the engineer immediately when an individual test is more than 3.0 percent below the specified minimum in standard spec 460.3.3.1. Investigate and determine the cause of the unacceptable test result.
- (2) The engineer may require unacceptable material specified in B.4.3(1) to be removed and replaced with acceptable material or allow the nonconforming material to remain in place with a 50 percent pay reduction. Determine limits of the unacceptable area by measuring density of the layer at 50-foot increments both ahead and behind the point of unacceptable density and at the same offset as the original test site. Continue testing at 50-foot increments until a point of acceptable density is found as specified in standard spec 460.5.2.2(1). Removal and replacement of material may be required if extended testing is in a previously accepted subplot. Testing in a previously accepted subplot will not be used to recalculate a new lot density.
- (3) Compute unacceptable pavement area using the product of the longitudinal limits of the unacceptable density and the full subplot width within the traffic lanes or shoulders.
- (4) Retesting and acceptance of replaced pavement will be as specified in standard spec 105.3.
- (5) Tests indicating density more than 3.0 percent below the specified minimum, and further tests taken to determine the limits of unacceptable area, are excluded from the computations of the subplot and lot densities.
- (6) If two consecutive subplot averages within the same paving pass and same target density are more than one percent below the specified target density, notify the engineer and take necessary corrective action. Document the locations of such sublots and the corrective action that was taken.

## **B.5 Department Testing**

### **B.5.1 Verification Testing**

- (1) The department will have a HTCP certified technician, or ACT working under a certified technician, perform verification testing. The department will test randomly at locations independent of the contractor's QC work. The department will perform verification testing at a minimum frequency of 10 percent of the sublots and a minimum of one subplot per mix design. The sublots selected will be within the active work zone. The contractor will supply the necessary traffic control for the department's testing activities.
- (2) The QV tester will test each selected subplot using the same testing requirements and frequencies as the QC tester.
- (3) If the verification subplot average is not more than one percent below the specified minimum target density, use the QC tests for acceptance.
- (4) If the verification subplot average is more than one percent below the specified target density, compare the QC and QV subplot averages. If the QV subplot average is within 1.0 lb/ft<sup>3</sup> of the QC subplot average, use the QC tests for acceptance.
- (5) If the first QV/QC subplot average comparison shows a difference of more than 1.0 lb/ft<sup>3</sup> each tester will perform an additional set of tests within that subplot. Combine the additional tests with the original set of tests to compute a new subplot average for each tester. If the new QV and QC subplot averages compare to within 1.0 lb/ft<sup>3</sup>, use the original QC tests for acceptance.
- (6) If the QV and QC subplot averages differ by more than 1.0 lb/ft<sup>3</sup> after a second set of tests, resolve the difference with dispute resolution specified in B.6. The engineer will notify the contractor immediately when density deficiencies or testing precision exceeding the allowable differences are observed.

### **B.5.2 Independent Assurance Testing**

- (1) Independent assurance is unbiased testing the department performs to evaluate the department's verification and the contractor's QC sampling and testing including personnel qualifications, procedures, and equipment. The department will perform the independent assurance review according to the department's independent assurance program.

## **B.6 Dispute Resolution**

- (1) The testers may perform investigation in the work zone by analyzing the testing, calculation, and documentation procedures. The testers may perform gauge comparison according to B.3.2.1.
- (2) The testers may use comparison monitoring according to B.3.2.2 to determine if one of the gauges is out of tolerance. If a gauge is found to be out of tolerance with its reference value, remove the gauge from the project and use the other gauge's test results for acceptance.

- (3) If the testing discrepancy cannot be identified, the contractor may elect to accept the QV subplot density test results or retesting of the subplot in dispute within 48 hours of paving. Traffic control costs will be split between the department and the contractor.
- (4) If investigation finds that both gauges are in error, the contractor and engineer will reach a decision on resolution through mutual agreement.

**B.7 Acceptance**

- (1) The department will not accept QMP HMA Pavement Nuclear Density if a non-compared gauge is used for contractor QC tests.

**C (Vacant)**

**D (Vacant)**

**E Payment**

**E.1 QMP Testing**

- (1) Costs for all sampling, testing, and documentation required under this special provision are incidental to the work. If the contractor fails to perform the work required under this special provision, the department may reduce the contractor's pay. The department will administer pay reduction under the Non-performance of QMP administrative item.

**E.2 Disincentive for HMA Pavement Density**

- (1) The department will administer density disincentives as specified in standard spec 460.5.2.2.

**E.3 Incentive for HMA Pavement Density**

- (1) The department will administer density incentives as specified in standard spec 460.5.2.3.  
stp-460-020 (20230629)

**35. HMA Pavement 4 SMA 58-28 V, Item 460.8624;  
HMA Pavement Test Strip Volumetrics, Item 460.0115.S;  
HMA Pavement Test Strip Density, Item 460.0120.S.**

**A Description**

Conform to standard spec 450 and 460 except as modified in this special provision.

**B (Vacant)**

**C Construction**

*Add the following to standard spec 450.3.1.3 to require transfer vehicle for SMA:*

- (2) Use a Material Transfer Vehicle when constructing SMA pavement.

*Add the following to standard spec 450.3.1.5 to prohibit rubber-tire roller on SMA:*

- (3) Do not use a rubber-tired roller for compaction of SMA pavement.

*Add the following to standard spec 460.3.3.2 to require and define approval criteria for SMA test strips:*

- (5) Construct a test strip according to CMM 815.13 to correlate nuclear gauges to pavement cores according to WTM T 355, confirm SMA in-place density using cores and determine mixture air voids. Submit the test strip start time and date to the department in writing at least 5 calendar days in advance of construction of the test strip. The department will assess the contractor \$2,000 for each instance according to Section E of this special provision if paving does not begin within 2 hours of the submitted start time, delaying the test strip. Alterations to the start time and date must be submitted to the department in writing a minimum of 24 hours prior to the start time. The contractor will not be liable for changes in start time related to adverse weather days as defined by standard spec 101.3 or equipment breakdown verified by the department.

Construct the test strip at the beginning of work for each SMA mixture, for each layer and for each thickness. All SMA test strip material produced shall meet the requirements in Tables 460-1 and 460-2 and conform to the JMF limits presented herein except as follows:

ITEM	JMF Limits
Asphaltic content in percent <sup>[1]</sup>	- 0.5
VMA in percent <sup>[2]</sup>	- 1.0
Air Voids in percent	According to the SMA Test Strip Approval Criteria Below

<sup>[1]</sup> Asphalt content more than -0.5% below the JMF will be referee tested by BTS using automated extraction according to WTM D8159.

<sup>[2]</sup> VMA limits based on minimum requirement for mix design nominal maximum aggregate size in table 460-1 as modified herein.

The test strip shall remain in place and become part of the completed pavement when acceptably produced, acceptably compacted, and meets finish and smoothness requirements. CMM 815 describes the SMA density and volumetric testing tolerances required for the test strip.

- (6) The test strip is to be treated as a single/separate lot and will have densities and pay adjustments calculated accordingly. The department will test one of the two split samples for volumetrics to determine test strip approval. If the QV air void sample is outside of the limits for 100% pay (i.e.,  $3.2 \leq Va \leq 5.8$ ), send both QV-retained split samples to BTS for dispute resolution testing. The results from the BTS dispute resolution testing will determine material conformance and payment for the test strip according to the SMA Prorated Pay Factors Table in CMM 836.9.3.3. If QV and QC test results exceed testing tolerances (0.015 for Gmm or Gmb), both retained split samples will be tested by BTS. In this case, additional investigation shall be conducted to identify the source of the difference between QV and QC data and BTS referee test data will be used to determine material conformance and pay.

Pay adjustments made as part of dispute resolution on test strip material will be limited to the test strip and will not extend to material placed during main production nor will pay adjustments made on main production extend into the test strip. The department will notify the contractor within 24 hours of the start of test strip construction regarding approval to proceed with paving beyond the test strip. The department will evaluate mixture air voids, test strip density, and nuclear gauge to core correlation in determining test strip approval and material conformance according to the following:

#### SMA Test Strip Approval Criteria

Approval / Material Conformance <sup>[1]</sup>	QV Air Voids	Average Density of All Cores <sup>[2]</sup>	Outcome of Test Strip for Contractor
Approved / Material Conforming	$3.2 \leq Va \leq 5.8$	$\geq 93.0 \%$	Proceed with production
Test Strip Approved / Material Nonconforming	$2.8 \leq Va \leq 3.2$ or $5.8 < Va \leq 6.2$	$\geq 91.0 \%$	Propose solution and proceed with production. Payment for material will be based on BTS referee tests.
Test Strip Not Approved / Material Nonconforming	$2.5 \leq Va < 2.8$ or $6.2 < Va \leq 6.5$	$< 91.0 \%$	Stop production, submit cause and solution, make additional 500-ton test strip. Payment for material will be based on BTS referee tests.
Test Strip and Material are Unacceptable <sup>[3]</sup>	$Va < 2.5$ or $Va > 6.5$	$< 90.0 \%$	Stop production, submit cause and solution, make additional 500-ton test strip, and complete new core to nuclear density gauge correlation.

<sup>[1]</sup> The overall result of each test strip will coincide with the more restrictive result from air voids or density.

<sup>[2]</sup> Individual nuclear density test results more than 3.0% below the minimum density requirement must be addressed according to CMM 815.11.

<sup>[3]</sup> Unacceptable material will be removed and replaced at no additional cost to the department. Alternatively, the engineer may allow the material to remain in place with a 50 percent payment factor. Material allowed to remain in place requires another test strip prior to additional paving.



- (7) An acceptable core to nuclear density gauge correlation must be completed by both the contractor and department according to CMM 815 as part of the test strip.
- (8) A maximum of two test strips will be allowed to remain in place per layer per contract. If the contractor changes the mix design for a given mix type during a contract, no additional compensation will be paid by the department for the required additional test strip and the department will assess the contractor \$2,000 for each additional test strip according to Section E of this special provision.

**D Measurement**

*Add the following to standard spec 460.4:*

- (2) The department will measure HMA Pavement Test Strip Volumetrics and HMA Pavement Test Strip Density as each unit of work, acceptably completed, as described in CMM 815. Material quantities will be determined according to standard spec 450.4.

**E Payment**

*Replace standard spec 460.5.1 with the following:*

The department will pay for measured quantities at the contract unit price under the following bid items:

ITEM NUMBER	DESCRIPTION	UNIT
460.8624	HMA Pavement 4 SMA 58-28 V	TON
460.0115.S	HMA Pavement Test Strip Volumetrics	EACH
460.0120.S	HMA Pavement Test Strip Density	EACH

Payment for SMA is full compensation for providing SMA mixture designs; for preparing foundation; for volumetric and density testing and aggregate source testing; for asphalt binder from recycled sources; for asphalt binder modification or processes; and addition of fibers, fines, or filler.

Payment for HMA Pavement Test Strip Volumetrics is full compensation for volumetric sampling, splitting, and testing; and for proper labeling, handling; and retention of split samples.

Payment for HMA Pavement Test Strip Density is full compensation for collecting and measuring of pavement cores, acceptably filling core holes, providing of nuclear gauges and operator(s), and all other work associated with completion of a core-to-gauge correlation, as directed by the engineer.

The department will pay separately for a material transfer vehicle.

Acceptable HMA mixture placed on the project as part of a volumetric or density test strip will be compensated by the appropriate HMA Pavement bid item with any applicable pay adjustments. If a test strip is delayed as defined in standard spec 460.3.3.2(5) as modified herein, the department will assess the contractor \$2,000 for each instance, under the HMA Delayed Test Strip administrative item. If an additional test strip is required because the initial test strip is not approved by the department, or the mix design is changed by the contractor, the department will assess the contractor \$2,000 for each additional test strip (i.e., \$2,000 for each individual volumetrics or density test strip) under the HMA Additional Test Strip administrative item.

stp-460-030 (20230629)

**36. HMA Percent Within Limits (PWL) Test Strip Volumetrics, Item 460.0105.S; HMA Percent Within Limits (PWL) Test Strip Density, Item 460.0110.S.**

**A Description**

This special provision describes the Hot Mix Asphalt (HMA) density and volumetric testing tolerances required for an HMA test strip. An HMA test strip is required for contracts constructed under HMA Percent Within Limits (PWL) QMP. A density test strip is required for each pavement layer placed over a specific, uniform underlying material, unless specified otherwise in the plans. Each contract is restricted to a single mix design per mix type per layer (e.g., upper layer and lower layer may have different mix type specified or may have the same mix type with different mix designs). Each mix design requires a separate test strip. Density and volumetrics testing will be conducted on the same test strip whenever possible.

Perform work according to standard spec 460 and as follows.

**B Materials**

Use materials conforming to HMA Pavement Percent Within Limits (PWL) QMP special provision.

## C Construction

### C.1 Test Strip

Submit the test strip start time and date to the department in writing at least 5 calendar days in advance of construction of the test strip. If the contractor fails to begin paving within 2 hours of the submitted start time, the test strip is delayed, and the department will assess the contractor \$2,000 for each instance according to Section E of this document. Alterations to the start time and date must be submitted to the department in writing a minimum of 24 hours prior to the start time. The contractor will not be liable for changes in start time related to adverse weather days as defined by standard spec 101.3 or equipment breakdown verified by the department.

On the first day of production for a test strip, produce approximately 750 tons of HMA. (Note: adjust tonnage to accommodate natural break points in the project.) Locate test strips in a section of the roadway to allow a representative rolling pattern (i.e., not a ramp or shoulder, etc.).

#### C.1.1 Sampling and Testing Intervals

##### C.1.1.1 Volumetrics

Laboratory testing will be conducted from a split sample yielding three components, with portions designated for QC (quality control), QV (quality verification), and retained.

During production for the test strip, obtain sufficient HMA mixture for three-part split samples from trucks prior to departure from the plant. Collect three split samples during the production of test strip material. Perform sampling from the truck box and three-part splitting of HMA according to WTM R47. These three samples will be randomly selected by the engineer from each *third* of the test strip tonnage (T), excluding the first 50 tons:

<u>Sample Number</u>	<u>Production Interval (tons)</u>
1	50 to 1/3 T
2	1/3 T to 2/3 T
3	2/3 T to T

##### C.1.1.2 Density

Required field tests include contractor QC and department QV nuclear density gauge tests and pavement coring at ten individual locations (five in each half of the test strip length) according to Appendix A: *Test Methods and Sampling for HMA PWL QMP Projects*. Both QV and QC teams shall have two nuclear density gauges present for correlation at the time the test strip is constructed. QC and QV teams may wish to scan with additional gauges at the locations detailed in Appendix A, as only gauges used during the test strip correlation phase will be allowed.

#### C.1.2 Field Tests

##### C.1.2.1 Density

For contracts that include STSP 460-020 QMP Density in addition to PWL, a gauge comparison according to WTM T355 shall be completed prior to the day of test strip construction. Daily standardization of gauges on reference blocks and a project reference site shall be performed according to WTM T355. A standard count shall be performed for each gauge on the material placed for the test strip, prior to any additional data collection. Nuclear gauge readings and pavement cores shall be used to determine nuclear gauge correlation according to Appendix A. The two to three readings for the five locations across the mat for each of two zones shall be provided to the engineer. The engineer will analyze the readings of each gauge relative to the densities of the cores taken at each location. The engineer will determine the average difference between the nuclear gauge density readings and the measured core densities to be used as a constant offset value. This offset will be used to adjust raw density readings of the specific gauge and shall appear on the density data sheet along with gauge and project identification. An offset is specific to the mix and layer; therefore, a separate value shall be determined for each layer of each mix placed over a differing underlying material for the contract. This constitutes correlation of that individual gauge for the given layer. Two gauges per team are not required to be onsite daily after completion of the test strip. Any data collected without a correlated gauge will not be accepted.

The contractor is responsible for coring the pavement from the footprint of the density tests and filling core holes according to Appendix A. Coring and filling of pavement core holes must be approved by the engineer. The QV team is responsible for the labeling and safe transport of the cores from the field to the QC laboratory. Testing of cores shall be conducted by the contractor and witnessed by department personnel. The contractor is responsible for drying the cores following testing. The department will take possession of cores following laboratory testing and will be responsible for any verification testing at the discretion of the engineer.

The target maximum density to be used in determining core density is the average of the three volumetric/mix Gmm values from the test strip multiplied by 62.24 lb/ft<sup>3</sup>. In the event mix and density portions of the test strip procedure are separated, or if an additional density test strip is required, the mix portion must be conducted prior to density determination. The target maximum density to determine core densities shall then be the Gmm four-test running average (or three-test average from a PWL volumetric-only test strip) from the end of the previous day's production multiplied by 62.24 lb/ft<sup>3</sup>. If no PWL production QV volumetric test is to be taken in a density-only test strip, a non-random QV test will be taken according to 460.2.8.3.1.4 as modified in HMA Pavement Percent Within Limits (PWL) QMP and if non-conforming to C.2.1 herein, follow corrective action outlined in 460.2.8.2.1.7(4) as modified in HMA Pavement Percent Within Limits (PWL) QMP.

Exclusions such as shoulders and appurtenances shall be tested and reported according to CMM 815. However, all acceptance testing of shoulders and appurtenances will be conducted by the department, and average lot (daily) densities must conform to standard spec Table 460-3. No density incentive or disincentive will be applied to shoulders or appurtenances. However, unacceptable shoulder material will be handled according to standard spec 460.3.3.1 and CMM 815.11.

### C.1.3 Laboratory Tests

#### C.1.3.1 Volumetrics

Obtain random samples according to C.1.1.1 and Appendix A. Perform tests the same day as taking the sample.

Theoretical maximum specific gravities of each mixture sample will be obtained. Bulk specific gravities of both gyratory compacted samples and field cores shall be determined. The bulk specific gravity values determined from field cores shall be used to calculate a correction factor (i.e., offset) for each QC and QV nuclear density gauge. The correction factor will be used throughout the remainder of the layer.

### C.2 Acceptance

#### C.2.1 Volumetrics

Produce mix conforming to the following limits based on individual QC and QV test results (tolerances based on most recent JMF):

ITEM	ACCEPTANCE LIMITS
Percent passing given sieve:	
37.5-mm	+/- 8.0
25.0-mm	+/- 8.0
19.0-mm	+/- 7.5
12.5-mm	+/- 7.5
9.5-mm	+/- 7.5
2.36-mm	+/- 7.0
75-µm	+/- 3.0
Asphaltic content in percent <sup>[1]</sup>	- 0.5
Air Voids	-1.5 & +2.0
VMA in percent <sup>[2]</sup>	- 1.0
Maximum specific gravity	+/- 0.024

<sup>[1]</sup> Asphalt content more than -0.5% below the JMF will be referee tested by the department's AASHTO accredited laboratory and HTCP certified personnel using automated extraction.

<sup>[2]</sup> VMA limits based on minimum requirement for mix design nominal maximum aggregate size in table 460-1.

QV samples will be tested for Gmm, Gmb, and AC. Air voids and VMA will then be calculated using these test results.

Calculation of air voids shall use either the QC, QV, or retained split sample test results, as identified by conducting the paired t-test with the WisDOT PWL Test Strip Spreadsheet.

If QC and QV test results do not correlate as determined by the split sample comparison, the retained split sample will be tested by the department's AASHTO accredited laboratory and HTCP certified personnel as a referee test. Additional investigation shall be conducted to identify the source of the difference between QC and QV data. Referee data will be used to determine material conformance and pay.

### C.2.2 Density

Compact all layers of test strip HMA mixture according to Table 460-3.

Nuclear density gauges are acceptable for use on the project only if correlation is completed for that gauge during the time of the test strip and the department issues documentation of acceptance stating the correlation offset value specific to the gauge and mix design. The offset is not to be entered into any nuclear density gauge as it will be applied by the department-furnished Field Density Worksheet.

### C.2.3 Test Strip Approval and Material Conformance

All applicable laboratory and field testing associated with a test strip shall be completed prior to any additional mainline placement of the mix. All test reports shall be submitted to the department upon completion and approved before paving resumes. The department will notify the contractor within 24 hours from start of test strip regarding approval to proceed with paving unless an alternate time frame is agreed upon in writing with the department. The 24-hour approval time includes only working days as defined in standard spec 101.3.

The department will evaluate material conformance and make pay adjustments based on the PWL value of air voids and density for the test strip. The QC core densities and QC and QV mix results will be used to determine the PWL values as calculated according to Appendix A.

The PWL values for air voids and density shall be calculated after determining core densities. An approved test strip is defined as the individual PWL values for air voids and density both being equal to or greater than 75, mixture volumetric properties conforming to the limits specified in C.2.1, and an acceptable gauge-to-core correlation. Further clarification on PWL test strip approval and appropriate post-test strip actions are shown in the following table:

PWL TEST STRIP APPROVAL AND MATERIAL CONFORMANCE CRITERIA

PWL VALUE FOR AIR VOIDS AND DENSITY	TEST STRIP APPROVAL	MATERIAL CONFORMANCE	POST-TEST STRIP ACTION
Both PWL $\geq$ 75	Approved <sup>1</sup>	Material paid for according to Section E	Proceed with Production
50 $\leq$ Either PWL < 75	Not Approved	Material paid for according to Section E	Consult BTS to determine need for additional test strip
Either PWL < 50	Not Approved	Unacceptable material removed and replaced or paid for at 50% of the contract unit price according to Section E	Construct additional Volumetrics or Density test strip as necessary

<sup>1</sup> In addition to these PWL criteria, mixture volumetric properties must conform to the limits specified in C.2.1, split sample comparison must have a passing result and an acceptable gauge-to-core correlation must be completed.

A maximum of two test strips will be allowed to remain in place per pavement layer per contract. If material is removed, a new test strip shall replace the previous one at no additional cost to the department. If the contractor changes the mix design for a given mix type during a contract, no additional compensation will be paid by the department for the required additional test strip and the department will assess the contractor \$2,000 for the additional test strip according to Section E of this special provision. For simultaneously conducted density and volumetric test strip components, the following must be achieved:

- i. Passing/Resolution of Split Sample Comparison
- ii. Volumetrics/mix PWL value  $\geq 75$
- iii. Density PWL value  $\geq 75$
- iv. Acceptable correlation

If not conducted simultaneously, the mix portion of a test strip must accomplish (i) and (ii), while density must accomplish (iii) and (iv). If any applicable criteria are not achieved for a given test strip, the engineer, with authorization from the department's Bureau of Technical Services, will direct an additional test strip (or alternate plan approved by the department) be conducted to prove the criteria can be met prior to additional paving of that mix. For a density-only test strip, determination of mix conformance will be according to main production, i.e., HMA Pavement Percent Within Limits (PWL) QMP special provision.

**D Measurement**

The department will measure HMA Percent Within Limits (PWL) Test Strip as each unit of work, acceptably completed as passing the required air void, VMA, asphalt content, gradation, and density correlation for a Test Strip. Material quantities shall be determined according to standard spec 450.4 and detailed here within.

**E Payment**

The department will pay for measured quantities at the contract unit price under the following bid item:

ITEM NUMBER	DESCRIPTION	UNIT
460.0105.S	HMA Percent Within Limits (PWL) Test Strip Volumetrics	EACH
460.0110.S	HMA Percent Within Limits (PWL) Test Strip Density	EACH

These items are intended to compensate the contractor for the construction of the test strip for contracts paved under the HMA Pavement Percent Within Limits QMP article.

Payment for HMA Percent Within Limits (PWL) Test Strip Volumetrics is full compensation for volumetric sampling, splitting, and testing, and for the proper labeling, handling, and retention of the split samples.

Payment for HMA Percent Within Limits (PWL) Test Strip Density is full compensation for collecting and measuring of pavement cores, acceptably filling core holes, providing of nuclear gauges and operator(s), and all other work associated with completion of a core-to-gauge correlation, as directed by the engineer.

Acceptable HMA mixture placed on the project as part of a volumetric or density test strip will be compensated by the appropriate HMA Pavement bid item with any applicable pay adjustments. If a test strip is delayed as defined in C.1 of this document, the department will assess the contractor \$2,000 for each instance, under the HMA Delayed Test Strip administrative item. If an additional test strip is required because the initial test strip is not approved by the department or the mix design is changed by the contractor, the department will assess the contractor \$2,000 for each additional test strip (i.e., \$2,000 for each individual volumetrics or density test strip) under the HMA Additional Test Strip administrative item.

Pay adjustment will be calculated using 65 dollars per ton of HMA pavement. The department will pay for measured quantities of mix based on \$65/ton multiplied by the following pay adjustment:

<b>PAY ADJUSTMENT FOR HMA PAVEMENT AIR VOIDS &amp; DENSITY</b>	
<i>PERCENT WITHIN LIMITS</i>	<i>PAYMENT FACTOR, PF</i>
<i>(PWL)</i>	<i>(percent of \$65/ton)</i>
$\geq 90$ to 100	$PF = ((PWL - 90) * 0.4) + 100$
$\geq 50$ to < 90	$(PWL * 0.5) + 55$
<50	50% <sup>[1]</sup>

where, PF is calculated per air voids and density, denoted  $PF_{\text{air voids}}$  and  $PF_{\text{density}}$

<sup>[1]</sup> Material resulting in PWL value less than 50 shall be removed and replaced, unless the engineer allows for such material to remain in place. In the event the material remains in place, it will be paid at 50% of the contract unit price of HMA pavement.

For air voids, PWL values will be calculated using lower and upper specification limits of 2.0 and 4.3 percent, respectively. Lower specification limits for density will be according to Table 460-3. Pay adjustment will be determined for an acceptably completed test strip and will be computed as shown in the following equation:

$$\text{Pay Adjustment} = (\text{PF}-100)/100 \times (\text{WP}) \times (\text{tonnage}) \times (\$65/\text{ton})^*$$

\*Note: If Pay Factor = 50, the contract unit price will be used in lieu of \$65/ton and the weighted percentage (WP) will equal 1.0.

The following weighted percentage (WP) values will be used for the corresponding parameter:

<u>Parameter</u>	<u>WP</u>
Air Voids	0.5
Density	0.5

Individual Pay Factors for each air voids ( $PF_{\text{air voids}}$ ) and density ( $PF_{\text{density}}$ ) will be determined.  $PF_{\text{air voids}}$  will be multiplied by the total tonnage produced (i.e., from truck tickets), and  $PF_{\text{density}}$  will be multiplied by the calculated tonnage used to pave the mainline only (i.e., traffic lane excluding shoulder) as determined according to Appendix A.

The department will pay incentive for air voids under the following bid item:

ITEM NUMBER	DESCRIPTION	UNIT
460.2005	Incentive Density PWL HMA Pavement	DOL
460.2010	Incentive Air Voids HMA Pavement	DOL

The department will administer disincentives under the Disincentive Density HMA Pavement and the Disincentive Air Voids HMA Pavement administrative items.

stp-460-040 (20230629)

### 37. HMA Pavement Percent Within Limits (PWL) QMP.

#### A Description

This special provision describes percent within limits (PWL) pay determination, providing and maintaining a contractor Quality Control (QC) Program, department Quality Verification (QV) Program, required sampling and testing, dispute resolution, corrective action, pavement density, and payment for HMA pavements. Pay is determined by statistical analysis performed on contractor and department test results conducted according to the Quality Management Program (QMP) as specified in standard spec 460, except as modified below.

#### B Materials

Conform to the requirements of standard spec 450, 455, and 460 except where superseded by this special provision. The department will allow only one mix design for each HMA mixture type per layer required for the contract, unless approved by the engineer. The use of more than one mix design for each HMA pavement layer will require the contractor to construct a new test strip according to HMA Pavement Percent Within Limits (PWL) QMP Test Strip Volumetrics and HMA Pavement Percent Within Limits (PWL) QMP Test Strip Density articles at no additional cost to the department.

*Replace standard spec 460.2.8.2.1.3.1 Contracts with 5000 Tons of Mixture or Greater with the following:*

#### 460.2.8.2.1.3.1 Contracts under Percent within Limits

(1) Furnish and maintain a laboratory at the plant site fully equipped for performing contractor QC testing. Have the laboratory on-site and operational before beginning mixture production.

(2) Obtain random samples and perform tests according to this special provision and further defined in Appendix A: *Test Methods & Sampling for HMA PWL QMP Projects*. Obtain HMA mixture samples from trucks at the plant. For the subplot in which a QV sample is collected, discard the QC sample and test a split of the QV sample.

(3) Perform sampling from the truck box and three-part splitting of HMA samples according to WTM R47. Sample size must be adequate to run the appropriate required tests in addition to one set of duplicate tests that may be required for dispute resolution (i.e., retained). This requires sample sizes which yield three splits for all random sampling per subplot. All QC samples shall provide the following: QC, QV, and Retained. The contractor shall take possession and test the QC portions. The department will observe the splitting and take possession of the samples intended for QV testing (i.e., QV portion from each sample) and the Retained portions. Additional sampling details are found in Appendix A. Label samples according to WTM R97. Additional handling instructions for retained samples are found in CMM 836.4 and CMM 836.5.

(4) Use the test methods identified below to perform the following tests at a frequency greater than or equal to that indicated:

- Blended aggregate gradations according to WTM T30.
- Asphalt content (AC) in percent.

Determine AC using one of the following methods:

- AC by ignition oven according to WTM T308. If the department is using an ignition oven to determine AC, conform to WTP [H-003](#). If the department is not using an ignition oven to determine AC, IOCFs must still be reverified for any of the reasons listed in [WTP H-003 Table 2](#) and conform to WTP H-003 section 3.
- AC by chemical extraction according to AASHTO T 164 Method A or B.
- AC by automated extraction according to WTM D8159.
- Bulk specific gravity (G<sub>mb</sub>) of the compacted mixture according to WTM T166.
- Maximum specific gravity (G<sub>mm</sub>) according to WTM T209.
- Air voids (V<sub>a</sub>) by calculation according to WTM T269.
- Voids in Mineral Aggregate (VMA) by calculation according to WTM R35.

(5) Lot size shall consist of 3750 tons with sublots of 750 tons. Test each design mixture at a frequency of one test per 750 tons of mixture type produced and placed as part of the contract. Add a random sample for any fraction of 750 tons at the end of production for a specific mixture design. Partial lots with less than three subplot tests will be included into the previous lot for data analysis and pay adjustment. Volumetric lots will include all tonnage of mixture type under specified bid item unless otherwise specified in the plan.

(6) Conduct field tensile strength ratio tests, without freeze-thaw conditioning cycles, on each qualifying mixture according to WTM T283 CMM 836.6.14. Test each full 50,000-ton production increment, or fraction of an increment, after the first 5,000 tons of production. Perform required increment testing in the first week of production of that increment. If field tensile strength ratio values are below the spec limit, notify the engineer. The engineer and contractor will jointly determine a corrective action.

*Delete standard spec 460.2.8.2.1.5 and 460.2.8.2.1.6.*

Replace standard spec 460.2.8.2.1.7 Corrective Action with the following:

**460.2.8.2.1.7 Corrective Action**

(1) Material must conform to the following action and acceptance limits based on individual QC and QV test results (tolerances relative to the JMF used on the PWL Test Strip):

ITEM	ACTION LIMITS	ACCEPTANCE LIMITS
Percent passing given sieve:		
37.5-mm	+/- 8.0	
25.0-mm	+/- 8.0	
19.0-mm	+/- 7.5	
12.5-mm	+/- 7.5	
9.5-mm	+/- 7.5	
2.36-mm	+/- 7.0	
75-µm	+/- 3.0	
AC in percent	-0.3	-0.5
Va		- 1.5 & +2.0
VMA in percent <sup>[1]</sup>	- 0.5	-1.0

[1] VMA limits based on minimum requirement for mix design nominal maximum aggregate size in table 460-1.

(2) QV samples will be tested for Gmm, Gmb, and AC. Air voids and VMA will then be calculated using these test results.

(3) Notify the engineer if any individual test result falls outside the action limits, investigate the cause and take corrective action to return to within action limits. If two consecutive test results fall outside the action limits, stop production. Production may not resume until approved by the engineer. Additional QV samples may be collected upon resuming production, at the discretion of the engineer.

(4) For any additional non-random tests outside the random number testing conducted for volumetrics, the data collected will not be entered into PWL calculations. Additional QV tests must meet acceptance limits or be subject to production stop. If the department’s non-random test does not conform to the acceptance limits, the retained sample will be tested by the BTS lab. If the BTS results also do not meet the acceptance limits, the material will be considered unacceptable as described in (5) below.

(5) Remove and replace unacceptable material at no additional expense to the department. Unacceptable material is defined as any individual QC or QV tests results outside the acceptance limits or a PWL value < 50. For AC in percent, unacceptable material is defined as any individual QV test result outside of the acceptance limit. The engineer may allow such material to remain in place with a price reduction. The department will pay for such HMA Pavement allowed to remain in place at 50 percent of the contract unit price.

Replace standard spec 460.2.8.3.1.2 Personnel Requirements with the following:

**460.2.8.3.1.2 Personnel Requirements**

(1) The department will provide at least one HTCP-certified Transportation Materials Sampling (TMS) Technician, to observe QV sampling of HMA mixtures.

(2) Under departmental observation, a contractor TMS technician shall collect and split samples.

(3) A department HTCP-certified Hot Mix Asphalt, Technician I, Production Tester (HMA-IPT) technician will ensure that all sampling is performed correctly and conduct testing, analyze test results, and report resulting data.

(4) The department will make an organizational chart available to the contractor before mixture production begins. The organizational chart will include names, telephone numbers, and current certifications of all QV testing personnel. The department will update the chart with appropriate changes, as they become effective.



Replace standard spec 460.2.8.3.1.4 Department Verification Testing Requirements with the following:

#### **460.2.8.3.1.4 Department Verification Testing Requirements**

(1) HTCP-certified department personnel will obtain QV random samples by directly supervising HTCP-certified contractor personnel sampling from trucks at the plant. Sample size must be adequate to run the appropriate required tests in addition to one set of duplicate tests that may be required for dispute resolution (i.e., retained). This requires sample sizes which yield three splits for all random sampling per subplot. All QV samples shall furnish the following: QC, QV, and Retained. The department will observe the splitting and take possession of the samples intended for QV testing (i.e., QV portion from each sample) and the Retained portions. The department will take possession of retained samples accumulated to date each day QV samples are collected. The department will retain samples until surpassing the analysis window of up to 5 lots, as defined in standard spec 460.2.8.3.1.7(2) of this special provision. Additional sampling details are found in Appendix A.

(2) The department will verify product quality using the test methods specified here in standard spec 460.2.8.3.1.4(3). The department will identify test methods before construction starts and use only those methods during production of that material unless the engineer and contractor mutually agree otherwise.

(3) The department will perform all testing conforming to the following standards:

- Bulk specific gravity (Gmb) of the compacted mixture according to WTM T166.
- Maximum specific gravity (Gmm) according to WTM T209.
- Air voids (Va) by calculation according to WTM T269.
- Voids in Mineral Aggregate (VMA) by calculation according to WTM R35.
- Asphalt Content (AC) in percent determined by ignition oven method according to WTM T308 and conforming to WTP H-003, chemical extraction according to AASHTO T 164 Method A or B, or automated extraction according to WTM D8159.

(4) The department will randomly test each design mixture at the minimum frequency of one test for each lot.

Delete standard spec 460.2.8.3.1.6.

Replace standard spec 460.2.8.3.1.7 Dispute Resolution with the following:

#### **460.2.8.3.1.7 Data Analysis for Volumetrics**

(1) Analysis of test data for pay determination will be contingent upon QC and QV test results. Statistical analysis will be conducted on Gmm and Gmb test results for calculation of Va. If either Gmm or Gmb analysis results in non-comparable data as described in 460.2.8.3.1.7(2), subsequent testing will be performed for both parameters as detailed in the following paragraph.

(2) The engineer, upon completion of the first 3 lots, will compare the variances (F-test) and the means (t-test) of the QV test results with the QC test results. Additional comparisons incorporating the first 3 lots of data will be performed following completion of the 4<sup>th</sup> and 5<sup>th</sup> lots (i.e., lots 1-3, 1-4, and 1-5). A rolling window of 5 lots will be used to conduct F & t comparison for the remainder of the contract (i.e., lots 2-6, then lots 3-7, etc.), reporting comparison results for each individual lot. Analysis will use a set alpha value of 0.025. If the F- and t-tests report comparable data, the QC and QV data sets are determined to be statistically similar and QC data will be used to calculate the Va used in PWL and pay adjustment calculations. If the F- and t-tests result in non-comparable data, proceed to the *dispute resolution* steps found below. Note: if both QC and QV Va PWL result in a pay adjustment of 102% or greater, dispute resolution testing will not be conducted. Dispute resolution via further investigation is as follows:

[<sup>1</sup>] The Retained portion of the split from the lot in the analysis window with a QV test result furthest from the QV mean (not necessarily the subplot identifying that variances or means do not compare) will be referee tested for Gmm, Gmb, and Asphalt Content by the bureau's AASHTO accredited laboratory and certified personnel. All previous lots within the analysis window are subject to referee testing and regional lab testing as deemed necessary. Referee test results will replace the QV data of the subplot(s).

<sup>[2]</sup> Statistical analysis will be conducted with referee test results replacing QV results.

- i. If the F- and t-tests indicate variances and means compare, no further testing is required for the lot and QC data will be used for PWL and pay factor/adjustment calculations.
- ii. If the F- and t-tests indicate non-comparable variances or means, the Retained portion of the random QC sample will be tested for Gmm, Gmb, and Asphalt Content by the department's regional lab for the remaining 4 sublots of the lot which the F- and t-tests indicate non-comparable datasets. The department's regional lab and the referee test results will be used for PWL and pay factor/adjustment calculations. Upon the second instance of non-comparable variance or means and for every instance thereafter, the department will assess a pay reduction for the additional testing of the remaining 4 sublots at \$2,000/lot under the HMA Regional Lab Testing administrative item.

<sup>[3]</sup> The contractor may choose to dispute the regional test results on a lot basis within 7 days after receiving the results from the region. In this event, the retained portion of each subplot will be referee tested by the department's AASHTO accredited laboratory and certified personnel. The referee Gmm and Gmb test results will supersede the regional lab results for the disputed lot.

- i. If referee testing results in an increased calculated pay factor, the department will pay for the cost of the additional referee testing.
- ii. If referee testing of a disputed lot results in an equal or lower calculated pay factor, the department will assess a pay reduction for the additional referee testing at \$2,000/lot under the Referee Testing administrative item.

<sup>(3)</sup> The department will notify the contractor of the referee test results within 3 working days after receipt of the samples by the department's AASHTO accredited laboratory. The intent is to provide referee test results within 7 calendar days from completion of the lot.

<sup>(4)</sup> The department will determine mixture conformance and acceptability by analyzing referee test results, reviewing mixture data, and inspecting the completed pavement according to the standard spec, this special provision, and accompanying Appendix A.

<sup>(5)</sup> Unacceptable material (i.e., resulting in a PWL value less than 50 or individual QC or QV test results not meeting the Acceptance Requirements of 460.2.8.2.1.7 as modified herein) will be referee tested by the bureau's AASHTO accredited laboratory and certified personnel and those test results used for analysis. Such material may be subject to remove and replace, at the discretion of the engineer. If the engineer allows the material to remain in place, it will be paid at 50% of the HMA Pavement contract unit price. Replacement or pay adjustment will be conducted on a subplot basis. If an entire PWL subplot is removed and replaced, the test results of the newly placed material will replace the original data for the subplot. Any remove and replace shall be performed at no additional cost to the department. Testing of replaced material must include a minimum of one QV result. [Note: If the removed and replaced material does not result in replacement of original QV data, an additional QV test will be conducted and under such circumstances will be entered into the HMA PWL Production spreadsheet for data analysis and pay determination.] The quantity of material paid at 50% the contract unit price will be deducted from PWL pay adjustments, along with accompanying data of this material.

*Delete standard spec 460.2.8.3.1.8 Corrective Action.*

## **C Construction**

*Replace standard spec 460.3.3.2 Pavement Density Determination with the following:*

### **460.3.3.2 Pavement Density Determination**

<sup>(1)</sup> The engineer will determine the target maximum density using department procedures described in WTM T355 and CMM 815. The engineer will determine density as soon as practicable after compaction and before placement of subsequent layers or before opening to traffic.

<sup>(2)</sup> Do not re-roll compacted mixtures with deficient density test results. Do not operate continuously below the specified minimum density. Stop production, identify the source of the problem, and make corrections to produce work meeting the specification requirements.

(3) A lot is defined as 7500 lane feet with sublots of 1500 lane feet (excluding shoulder, even if paved integrally) and placed within a single layer for each location and target maximum density category indicated in table 460-3. The contractor is required to complete three tests randomly per subplot and the department will randomly conduct one QV test per subplot. A partial quantity less than 750 lane feet will be included with the previous subplot. Partial lots with less than three sublots will be included in the previous lot for data analysis/acceptance and pay, by the engineer. If density lots/sublots are determined prior to construction of the test strip, any random locations within the test strip shall be omitted. Exclusions such as shoulders and appurtenances shall be tested and recorded according to CMM 815. However, all acceptance testing of shoulders and appurtenances will be conducted by the department, and average lot (daily) densities must conform to standard spec Table 460-3 or else be subject to disincentives according to 460.5.2.2(5) herein. No density incentive will be applied to shoulders or appurtenances. Offsets will not be applied to nuclear density gauge readings for shoulders or appurtenances. Unacceptable shoulder material will be handled according to standard spec 460.3.3.1 and CMM 815.11.

(4) The three QC locations per subplot represent the outside, middle, and inside of the paving lane. The QC density testing procedures are detailed in Appendix A.

(5) QV nuclear testing will consist of one randomly selected location per subplot. The QV density testing procedures will be the same as the QC procedure at each testing location and are also detailed in Appendix A.

(6) An HTCP-certified nuclear density technician (NUCDENSITYTEC-I) shall identify random locations and perform the testing for both the contractor and department. The responsible certified technician shall ensure that sample location and testing is performed correctly, analyze test results, and provide density results to the contractor weekly, or at the completion of each lot.

(7) For any additional tests outside the random number testing conducted for density, the data collected will not be entered into PWL calculations. However, additional QV testing must meet the tolerances for material conformance as specified in the standard specification and this special provision. If additional density data identifies unacceptable material, proceed as specified in CMM 815.11.

*Replace standard spec 460.3.3.3 Waiving Density Testing with Acceptance of Density Data with the following:*

#### **460.3.3.3 Analysis of Density Data**

(1) Analysis of test data for pay determination will be contingent upon test results from both the contractor (QC) and the department (QV).

(2) As random density locations are paved, the data will be recorded in the HMA PWL Production Spreadsheet for analysis in chronological order. The engineer, upon completion of the first 3 lots, will compare the variances (F-test) and the means (t-test) of the QV test results with the QC test results. A rolling window of 3 lots will be used to conduct F & t comparison for the remainder of the contract (i.e., lots 2-4, then lots 3-5, etc.), reporting comparison results for each individual lot. Analysis will use a set alpha value of 0.025.

- i. If the F- and t-tests indicate variances and means compare, the QC and QV data sets are determined to be statistically similar and QC data will be used for PWL and pay adjustment calculations.
- ii. If the F- and t-tests indicate variances or means do not compare, the QV data will be used for subsequent calculations.

(3) The department will determine mixture density conformance and acceptability by analyzing test results, reviewing mixture data, and inspecting the completed pavement according to standard spec, this special provision, and accompanying Appendix A.

(4) Density resulting in a PWL value less than 50 or not meeting the requirements of 460.3.3.1 (any individual density test result falling more than 3.0 percent below the minimum required target maximum density as specified in standard spec Table 460-3) is unacceptable and may be subject to remove and replace at no additional cost to the department, at the discretion of the engineer.

- i. Replacement may be conducted on a subplot basis. If an entire PWL subplot is removed and replaced, the test results of the newly placed material will replace the original data for the subplot.

- ii. Testing of replaced material must include a minimum of one QV result. [Note: If the removed and replaced material does not result in replacement of original QV data, an additional QV test must be conducted and under such circumstances will be entered into the data analysis and pay determination.]
- iii. If the engineer allows such material to remain in place, it will be paid for at 50% of the HMA Pavement contract unit price. The extent of unacceptable material will be addressed as specified in CMM 815.11. The quantity of material paid at 50% the contract unit price will be deducted from PWL pay adjustments, along with accompanying data of this material.

**D Measurement**

The department will measure the HMA Pavement bid items acceptably completed by the ton, as specified in standard spec 450.4 and as follows in standard spec 460.5, as modified in this special provision.

**E Payment**

Replace standard spec 460.5.2 HMA Pavement with the following:

**460.5.2 HMA Pavement**

**460.5.2.1 General**

(1) Payment for HMA Pavement Type LT, MT, and HT mixes is full compensation for providing HMA mixture designs; for preparing foundation; for furnishing, preparing, hauling, mixing, placing, and compacting mixture; for HMA PWL QMP testing and aggregate source testing; for warm mix asphalt additives or processes; for stabilizer, hydrated lime and liquid antistripping agent, if required; and for all materials including asphaltic materials.

(2) If provided for in the plan quantities, the department will pay for a leveling layer, placed to correct irregularities in an existing paved surface before overlaying, under the pertinent paving bid item. Absent a plan quantity, the department will pay for a leveling layer as extra work.

**460.5.2.2 Calculation of Pay Adjustment for HMA Pavement using PWL**

(1) Pay adjustments will be calculated using 65 dollars per ton of HMA pavement. The HMA PWL Production Spreadsheet, including data, will be made available to the contractor by the department as soon as practicable upon completion of each lot. The department will pay for measured quantities of mix based on this price multiplied by the following pay adjustment calculated according to the HMA PWL Production Spreadsheet:

**PAY FACTOR FOR HMA PAVEMENT AIR VOIDS & DENSITY**

<i>PERCENT WITHIN LIMITS</i> (PWL)	<i>PAYMENT FACTOR, PF</i> (percent of \$65/ton)
≥ 90 to 100	PF = ((PWL – 90) * 0.4) + 100
≥ 50 to < 90	(PWL * 0.5) + 55
<50	50% <sup>[1]</sup>

where PF is calculated per air voids and density, denoted PF<sub>air voids</sub> and PF<sub>density</sub>.

<sup>[1]</sup> Any material resulting in PWL value less than 50 shall be removed and replaced unless the engineer allows such material to remain in place. In the event the material remains in place, it will be paid at 50% of the contract unit price of HMA pavement.

(2) For air voids, PWL values will be calculated using lower and upper specification limits of 2.0 and 4.3 percent, respectively. Lower specification limits for density shall be according to standard spec Table 460-3.

(3) Pay adjustment will be determined on a lot basis and will be computed as shown in the following equation:

$$\text{Pay Adjustment} = (\text{PF}-100)/100 \times (\text{WP}) \times (\text{tonnage}) \times (\$65/\text{ton})^*$$

\*Note: If Pay Factor = 50, the contract unit price will be used in lieu of \$65/ton and the weighted percentage (WP) will equal 1.0.

The following weighted percentage (WP) values will be used for the corresponding parameter:

<u>Parameter</u>	<u>WP</u>
Air Voids	0.5
Density	0.5

(4) Individual Pay Factors for each air voids ( $PF_{\text{air voids}}$ ) and density ( $PF_{\text{density}}$ ) will be determined.  $PF_{\text{air voids}}$  will be multiplied by the total tonnage placed (i.e., from truck tickets), and  $PF_{\text{density}}$  will be multiplied by the calculated tonnage used to pave the mainline only (i.e., travel lane excluding shoulder) as determined according to Appendix A.

(5) Pay adjustment for shoulders and appurtenances accepted by department testing will be determined on a lot basis. If the lot density is less than the specified minimum in table 460-3, the department will reduce pay based on the contract unit price for the HMA pavement bid item for that lot as follows:

<b>DISINCENTIVE PAY REDUCTION FOR HMA PAVEMENT DENSITY</b>	
PERCENT LOT DENSITY	PAYMENT FACTOR
BELOW SPECIFIED MINIMUM	(percent of contract price)
From 0.5 to 1.0 inclusive	98
From 1.1 to 1.5 inclusive	95
From 1.6 to 2.0 inclusive	91
From 2.1 to 2.5 inclusive	85
From 2.6 to 3.0 inclusive	70
More than 3.0 <sup>[1]</sup>	—

<sup>[1]</sup> Remove and replace the lot with a mixture at the specified density. When acceptably replaced, the department will pay for the replaced work at the contract unit price. Alternatively, the engineer may allow the nonconforming material to remain in place with a 50 percent payment factor.

(6) The department will pay incentive for air voids and density under the following bid items:

ITEM NUMBER	DESCRIPTION	UNIT
460.2005	Incentive Density PWL HMA Pavement	DOL
460.2010	Incentive Air Voids HMA Pavement	DOL

The department will administer disincentives under the Disincentive Density HMA Pavement and the Disincentive Air Voids HMA Pavement administrative items.

The department will administer a disincentive under the Disincentive HMA Binder Content administrative item for each individual QV test result indicating asphalt binder content below the Action Limit in 460.2.8.2.1.7 presented herein. The department will adjust pay per subplot of mix at 65 dollars per ton of HMA pavement multiplied by the following pay adjustment calculated according to the HMA PWL Production Spreadsheet:

<u>AC Binder Relative to JMF</u>	<u>Pay Adjustment / Sublot</u>
-0.4% to -0.5%	75% <sup>[1]</sup>
More than -0.5%	50% <sup>[1] [2]</sup>

<sup>[1]</sup> Any material resulting in an asphalt binder content more than 0.3% below the JMF AC content will be referee tested by the department's AASHTO accredited laboratory and HTCP certified personnel using automated extraction according to automated extraction according to WTM D8159.

<sup>[2]</sup> Any material resulting in an asphalt binder content more than 0.5% below the JMF AC content shall be removed and replaced unless the engineer allows such material to remain in place. In the event the material remains in place, it will be paid at 50% of the contract unit price of HMA pavement.

Note: PWL value determination is further detailed in the PWL Production Spreadsheet Instructions located in the *Project Info & Instructions* tab of the HMA PWL Production spreadsheet.

stp-460-050 (20230629)

## 38. Appendix A.

### Test Methods & Sampling for HMA PWL QMP Projects

The following procedures are included with the HMA Pavement Percent Within Limits (PWL) Quality Management Program (QMP) special provision:

- WisDOT Procedure for Nuclear Gauge/Core Correlation – Test Strip
- WisDOT Test Method for HMA PWL QMP Density Measurements for Main Production
- Sampling for WisDOT HMA PWL QMP
- Calculation of PWL Mainline Tonnage Example

#### WisDOT Procedure for Nuclear Gauge/Core Correlation – Test Strip

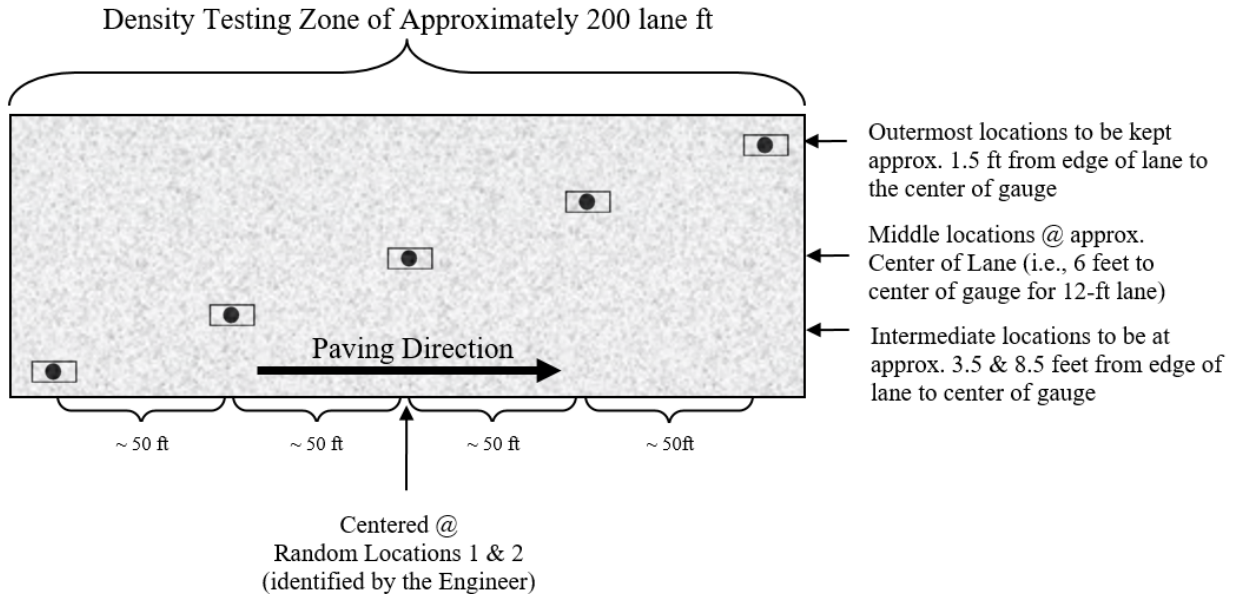

**Figure 1: Nuclear/Core Correlation Location Layout**

The engineer will identify two zones in which gauge/core correlation is to be performed. These two zones will be randomly selected within each *half* of the test strip length. (Note: Density zones shall not overlap and must have a minimum of 100 feet between the two zones; therefore, random numbers may be shifted (evenly) in order to meet these criteria.) Each zone shall consist of five locations across the mat as identified in Figure 1. The following shall be determined at each of the five locations within both zones:

- two one-minute nuclear density gauge readings for QC team\*
- two one-minute nuclear density gauge readings for QV team\*
- pavement core sample

\*If the two readings exceed 1.0 pcf of one another, a third reading is conducted in the same orientation as the first reading. In this event, all three readings are averaged, the individual test reading of the three which falls farthest from the average value is discarded, and the average of the remaining two values is used to represent the location for the gauge.

The zones are supposed to be undisclosed to the contractor/roller operators. The engineer will not lay out density/core test sites until rolling is completed and the cold/finish roller is beyond the entirety of the zone. Sites are staggered across the 12-foot travel lane, and do not include shoulders. The outermost locations should be 1.5-feet from the center of the gauge to the edge of lane. [NOTE: This staggered layout is only applicable to the test strip. All mainline density locations after test strip should have a longitudinal- as well as transverse-random number to determine location as detailed in the *WisDOT Test Method for HMA PWL QMP Density Measurements for Main Production* section of this document.]

Individual locations are represented by the  symbol as seen in Figure 1 above. The symbol is two-part, comprised of the nuclear test locations and the location for coring the pavement, as distinguished here:



The nuclear site is the same for QC and QV readings for the test strip, i.e., the QC and QV teams are to take nuclear density gauge readings in the same footprint. Each of the QC and QV teams are to take a minimum of two one-minute readings per nuclear site, with the gauge rotated 180 degrees between readings, as seen here:



**Figure 2: Nuclear gauge orientation for (a) 1<sup>st</sup> one-minute reading and (b) 2<sup>nd</sup> one-minute reading**

Photos should be taken of each of the 10 core/gauge locations of the test strip. This should include gauge readings (pcf) and a labelled core within the gauge footprint. If a third reading is needed, all three readings should be recorded and documented. Only raw readings in pcf should be written on the pavement during the test strip, with a corresponding gauge ID/SN (generalized as QC-1 through QV-2 in the following Figure) in the following format:



**Figure 3: Layout of raw gauge readings as recorded on pavement**

Each core will then be taken from the center of the gauge footprint and will be used to correlate each gauge with laboratory-measured bulk specific gravities of the pavement cores. One core in good condition must be obtained from each of the 10 locations. If a core is damaged at the time of extracting from the pavement, a replacement core should be taken immediately adjacent to the damaged core, i.e., from the same footprint. If a core is damaged during transport, it should be recorded as damaged and excluded from the correlation. Coring after traffic is on the pavement should be avoided. The contractor is responsible for coring of the pavement. Coring and filling of core holes must be approved by the engineer. The QV team is responsible for the labeling and safe transport of the cores from the field to the QC laboratory. Core density testing will be conducted by the contractor and witnessed by department personnel. The contractor is responsible for drying the cores following testing. The department will take possession of cores following initial testing and is responsible for any verification testing.

Each core 100 or 150 mm (4 or 6 inches) in diameter will be taken at locations as identified in Figure 1. Each random core will be full thickness of the layer being placed. The contractor is responsible for thoroughly drying cores obtained from the mat according to WTM R79 prior to using specimens for in-place density determination according to WTM T166.

Cores must be taken before the pavement is open to traffic. Cores are cut under department/project staff observation. Relabel each core immediately after extruding or ensure that labels applied to pavement prior to cutting remain legible. The layer interface should also be marked immediately following extrusion. Cores should be cut at this interface, using a wet saw, to allow for density measurement of only the most



recently placed layer. Cores should be protected from excessive temperatures such as direct sunlight. Also, there should be department custody (both in transport and storage) for the cores until they are tested whether that be immediately after the test strip or subsequent day if agreed upon between department and contractor. Use of concrete cylinder molds works well to transport cores. Cores should be placed upside down (flat surface to bottom of cylinder mold) in the molds, one core per mold, cylinder molds stored upright, and ideally transported in a cooler. Avoid any stacking of pavement cores.

Fill all core holes with non-shrink rapid-hardening grout, mortar, or concrete, or with HMA. When using grout, mortar, or concrete, remove all water from the core holes prior to filling. Mix the mortar or concrete in a separate container prior to placement in the hole. If HMA is used, fill all core holes with hot-mix matching the same day's production mix type at same day compaction temperature +/- 20 F. The core holes shall be dry and coated with tack before filling, filled with a top layer no thicker than 2.25 inches, lower layers not to exceed 4 inches, and compacted with a Marshall hammer or similar tamping device using approximately 50 blows per layer. The finished surface shall be flush with the pavement surface. Any deviation in the surface of the filled core holes greater than 1/4 inch at the time of final inspection will require removal of the fill material to the depth of the layer thickness and replacement.

### **WisDOT Test Method for HMA PWL QMP Density Measurements for Main Production**

For nuclear density testing of the pavement beyond the test strip, QC tests will be completed at three locations per subplot, with a subplot defined as 1500 lane feet. The three locations will represent the outside, middle, and inside of the paving lane (i.e., the lane width will be divided into thirds as shown by the dashed longitudinal lines in Figure 3 and random numbers will be used to identify the specific transverse location within each third according to CMM 815). Longitudinal locations within each subplot shall be determined with 3 independent random numbers. The PWL Density measurements do not include the shoulder and other appurtenances. Such areas are tested by the department and are not eligible for density incentive but are subject to disincentive according to 460.5.2.2(5) of the HMA PWL QMP article. Each location will be measured with two one-minute gauge readings oriented 180 degrees from one another, in the same footprint as detailed in Figure 2 above. Each location requires a minimum of two readings per gauge. The density gauge orientation for the first test will be with the source rod towards the direction of paving. QV nuclear testing will consist of one randomly selected location per subplot. The QV is also comprised of two one-minute readings oriented 180 degrees from one another. For both QC and QV test locations, if the two readings exceed 1.0 pcf of one another, a third reading is conducted in the same orientation as the first reading. In this event, all three readings are averaged, the individual test reading of the three which falls farthest from the average value is discarded, and the average of the remaining two values is used to represent the location for the gauge. The subplot density testing layout is depicted in Figure 4, with QC test locations shown as solid lines and QV as dashed.

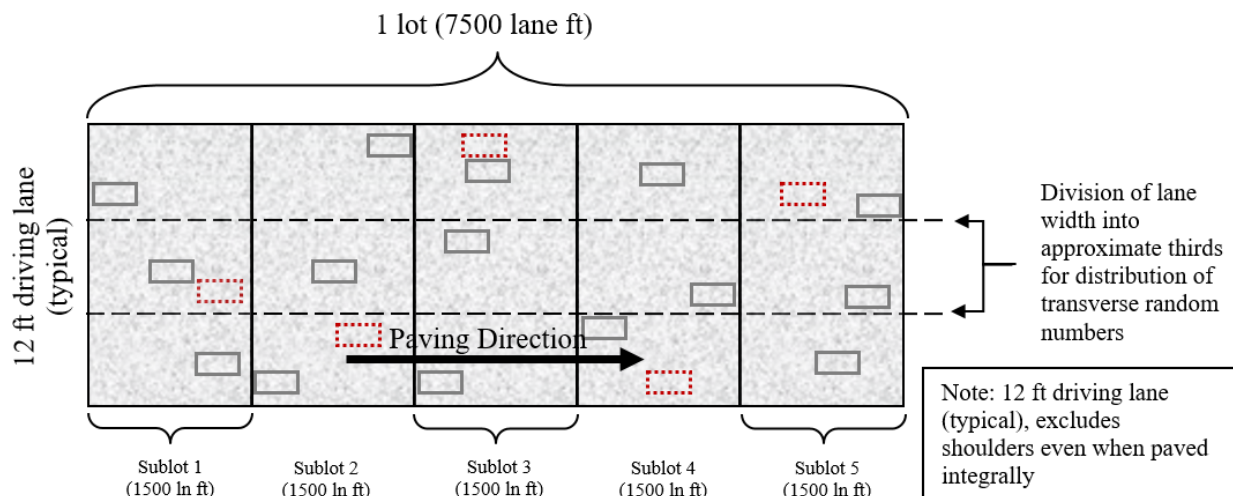

**Figure 4: Locations of main lane HMA density testing (QC=solid lines, QV=dashed)**



Raw nuclear density data must be shared by both parties at the end of each shift. Paving may be delayed if the raw data is not shared in a timely manner. QC and QV nuclear density gauge readings will be statistically analyzed according to Section 460.3.3.3 of the HMA PWL QMP article. (Note: For density data, if F- and t-tests compare, QC data will be used for the subsequent calculations of PWL value and pay determination. However, if an F- or t-test does not compare, the QV data will be used in subsequent calculations.)

Investigative cores will be allowed on the approaching side of traffic outside of the footprint locations. Results must be shared with the department.

The QV density technician is expected to be onsite within 1 hour of the start of paving operations and should remain on-site until all paving is completed. Perform footprint testing as soon as both the QC and QV nuclear density technician are onsite and a minimum of once per day to ensure the gauges are not drifting apart during a project. Footprint testing compares the density readings of two gauges at the same testing location and can be done at any randomly selected location on the project. Both teams are encouraged to conduct footprint testing as often as they feel necessary. Footprint testing does not need to be performed at the same time. At project start-up, the QV should footprint the first 10 QC locations. Individual density tests less than 0.5% above the lower limit should be communicated to the other party and be footprint tested. Each gauge conducts 2 to 3 1-minute tests according to WTM T355 and the final results from each gauge are compared for the location. If the difference between the QC and QV gauges exceeds 1.0 pcf (0.7 percent) for an average of 10 locations, investigate the cause, check gauge moisture and density standards and perform additional footprint testing. If the cause of the difference between gauge readings cannot be identified, the regional HMA Coordinator will consult the RSO, the regional PWL representative and the BTS HMA unit to determine necessary actions. If it is agreed that there is a gauge comparison issue, perform one of the following two options:

#### **New Gauge Combination**

- All 4 gauges used on the test strip must footprint 10 locations on the pavement. Pavement placed on a previous day may be used.
- The results of the footprint testing will be analyzed to see if a better combination of acceptable gauges is available.
- If a better combination is found, those gauges should be used moving forward.
- If a better combination cannot be found, a new gauge correlation must be performed. (see below)

#### **Re-correlation of Gauges**

- Follow all test strip procedures regarding correlating gauges except the following:
  - The 10 locations can be QC or QV random locations.
  - The locations used may have been paved on a previous day.
- Retesting with gauges must be done immediately prior to coring.
- New gauge offsets will be used for that day's paving and subsequent paving days. New gauge offsets will not be used to recalculate density results from prior days.

#### **Density Dispute Resolution Procedure**

Density results may be disputed by the contractor on a lot-by-lot basis if one of the following criteria is met:

- The lot average for either QC or QV is below the lower specification limit.
- The lot average for QC is different from the lot average for QV by more than 0.5%.

In lieu of using density gauges for acceptance of the lot, the lot will be cored in the QV locations. The results of the cores from the entire lot will be entered in the spreadsheet and used for payment. If the pay factor increases, the contractor will only receive the additional difference in payment for the disputed lot. If the pay factor does not increase, the department will assess the contractor \$2,000 for the costs of additional testing.

Notify the engineer in writing before dispute resolution coring. Immediately prior to coring, QC and QV will test the locations with nuclear density gauges.

Under the direct observation of the engineer, cut 100 or 150 mm (4 or 6 inch) diameter cores. Cores will be cut by the next day after completion of the lot, except if the next day is not a working day, then they shall be cut within 48 hours of placement. Prepare cores and determine density according to WTM T166. Dry cores after testing. Fill core holes according to Appendix A and obtain engineer approval before opening to traffic. The department will maintain custody of cores throughout the entire sampling and testing process. The department will label cores, transport cores to testing facilities, witness testing, store dried cores, and provide subsequent verification testing. If a core is damaged at the time of coring, immediately take a replacement core 1 foot ahead of the existing testing location in the direction of traffic at the same offset as the damaged core. If a core is damaged during transport, record it as damaged and notify the engineer immediately.

### **Sampling for WisDOT HMA PWL QMP Production**

Sampling of HMA mix for QC, QV and Retained samples shall conform to WTM R97 and WTM R47 except as modified here.

#### **Sampling Hot Mix Asphalt**

At the beginning of the contract, the contractor determines the anticipated tonnage to be produced. The frequency of sampling is 1 per 750 tons (sublot) for QC and Retained Samples and 1 per 3750 tons (lot or 5 sublots) for QV as defined by the HMA PWL QMP article. A test sample is obtained randomly from each sublot. Each random sample shall be collected at the plant according to WTM R97. The contractor must submit the random numbers for all mix sampling to the department before production begins.

#### *Example 1*

Expected production for a contract is 12,400 tons. The number of required samples is determined based on this expected production (per HMA PWL QMP SPV) and is determined by the random sample calculation.

- Sample 1 – from 50 to 750 tons
- Sample 2 – from 751 to 1500 tons
- Sample 3 – from 1501 to 2250 tons
- Sample 4 – from 2251 to 3000 tons
- Sample X – .....
- Sample 16 – from 11,251 to 12,000 tons
- Sample 17 – from 12,001 to 12,400 tons

The approximate location of each sample within the prescribed sublots is determined by selecting random numbers using WTM D3665 or by using a calculator or computerized spreadsheet that has a random number generator. The random numbers selected are used in determining when a sample is to be taken and will be multiplied by the sublot tonnage. This number will then be added to the final tonnage of the previous sublot to yield the approximate cumulative tonnage of when each sample is to be taken.

To allow for plant start-up variability, the procedure calls for the first random sample to be taken at 50 tons or greater per production day (not intended to be taken in the first two truckloads). Random samples calculated for 0-50 ton should be taken in the next truck (51-75 ton).

This procedure is to be used for any number of samples per contract.

If the production is less than the final randomly generated sample tonnage, then the random sample is to be collected from the remaining portion of that sublot of production. If the randomly generated sample is calculated to be within the first 0-50 tons of the subsequent day of production, it should be taken in the next truck. Add a random sample for any fraction of 750 tons at the end of the contract. Lot size will consist of 3750 tons with sublots of 750 tons. Partial lots with less than three sublot tests will be included into the previous lot, by the engineer.

It is intended that the plant operator not be advised ahead of time when samples are to be taken.

If belt samples are used during troubleshooting, the blended aggregate will be obtained when the mixture production tonnage reaches approximately the sample tonnage. For plants with storage silos, this could be up to 60 minutes in advance of the mixture sample that's taken when the required tonnage is shipped from the plant.

QC, QV, and retained samples shall be collected for all test strip and production mixture testing using a three-part splitting procedure according to WTM R47.

### **Calculation of PWL Mainline Tonnage Example**

A mill and overlay project is being constructed with a 12-foot travel lane and an integrally paved 3-foot shoulder. The layer thickness is 2 inches for the full width of paving. Calculate the tonnage in each subplot eligible for density incentive or disincentive.

**Solution:**

$$\frac{1500 \text{ ft} \times 12 \text{ ft}}{9 \text{ sf/sy}} \times \frac{2 \text{ in} \times 112 \text{ lb/sy/in}}{2000 \text{ lb/ton}} = 224 \text{ tons}$$

stp-460-055 (20230629)

## **39. HMA Pavement Longitudinal Joint Density.**

### **A Description**

This special provision incorporates longitudinal joint density requirements into the contract and describes the data collection, acceptance, and procedure used for determination of pay adjustments for HMA pavement longitudinal joint density. Pay adjustments will be made on a linear foot basis, as applicable per pavement layer and paving lane. Applicable longitudinal joints are defined as those between any two or more traffic lanes including full-width passing lanes, turn lanes, or auxiliary lanes more than 1,500 lane feet, and those lanes must also include the 460.2005 Incentive Density PWL HMA Pavement bid item. This excludes any joint with one side defined as a shoulder and ramp lanes of any length. If echelon paving is required in the contract, the longitudinal joint density specification shall not apply for those joints. Longitudinal joints placed during a test strip will be tested for information only to help ensure the roller pattern will provide adequate longitudinal joint density during production. Longitudinal joint density test results collected during a test strip are not eligible for pay adjustment.

Pay is determined according to standard spec 460, HMA Pavement Percent Within Limits QMP special provisions, and as modified within.

### **B Materials**

Compact all applicable HMA longitudinal joints to the appropriate density based on the layer, confinement, and mixture type shown in Table B-1.

**TABLE B-1 MINIMUM REQUIRED LONGITUDINAL JOINT DENSITY**

Layer	Percent of Target Maximum Density			
	Unconfined		Confined	
	LT and MT	HT	LT and MT	HT
Lower (on crushed/recycled base)	88	89	89.5	90.5
Lower (on Concrete/HMA)	90 <sup>[1]</sup>	90 <sup>[1]</sup>	91.5 <sup>[1]</sup>	91.5 <sup>[1]</sup>
Upper	90	90	91.5	91.5

<sup>[1]</sup> Minimum reduced by 1.0 percent for a 1.25-inch-thick No. 5 mix lower layer constructed on a paved or milled surface.

## C Construction

Add the following to standard spec 460.3.3.2:

- (5) Establish companion density locations at each applicable joint. Each companion location shares longitudinal stationing with a QC or QV density location within each subplot and is located transversely with the center of the gauge 6-inches from the final joint edge of the paving area. Sublot and lot numbering remains the same as mainline densities, however, in addition to conventional naming, joint identification must clearly indicate “M” for inside/median side of lane or “O” for outside shoulder side of lane, as well as “U” for an unconfined joint or “C” for a confined joint (e.g., XXXXX-MC or XXXXX-OU).
- (6) Each joint will be measured, reported, and accepted under methods, testing times, and procedures consistent with the program employed for mainline density, i.e., PWL.
- (7) For single nuclear density test results greater than 3.0% below specified minimums per Table B-1 herein, perform the following:
  - a) Testing at 50-foot increments both ahead and behind the unacceptable site.
  - b) Continued 50-foot incremental testing until test values indicate higher than or equal to -3.0 percent from target joint density.
  - c) Materials within the incremental testing indicating lower than -3.0 percent from target joint density are defined as unacceptable and will be handled with remedial action as defined in the payment section of this document.
  - d) The remaining subplot average (exclusive of unacceptable material) will be determined by the first forward and backward 50-foot incremental tests that reach the criteria of higher than or equal to -3.0 percent from target joint density.

Note: If the 50-foot testing extends into a previously accepted subplot, remedial action is required up to and inclusive of such material; however, the results of remedial action must not be used to recalculate the previously accepted subplot density. When this occurs, the lane feet of any unacceptable material will be deducted from the subplot in which it is located, and the previously accepted subplot density will be used to calculate pay for the remainder of the subplot.

- (8) Joint density measurements will be kept separate from all other density measurements and entered as an individual data set into Atwood Systems.
- (9) Placement and removal of excess material outside of the final joint edge, to increase joint density at the longitudinal joint nuclear testing location, will be done at the contractor’s discretion and cost. This excess material and related labor will be considered waste and will not be paid for by the department. Joints with excess material placed outside of the final joint edge to increase joint density or where a notched wedge is used will be considered unconfined joints.
- (10) When not required by the contract, echelon paving may be performed at the contractor’s discretion to increase longitudinal joint density and still remain eligible to earn incentive. The additional costs incurred related to echelon paving will not be paid for by the department. If lanes are paved in echelon, the contractor may choose to use a longitudinal vertical joint or notched wedge longitudinal joint as described in [SDD 13c19](#). Lanes paved in echelon shall be considered confined on both sides of the joint regardless of the selected joint design. The joint between echelon paved lanes shall be placed at the centerline or along lane lines.
- (11) When performing inlay paving below the elevation of the adjacent lane, the longitudinal joint along the adjacent lane to be paved shall be considered unconfined.

## D Measurement

- (1) The department will measure each side of applicable longitudinal joints, as defined in Section A of this special provision, by the linear foot of pavement, acceptably placed. Measurement will be conducted independently for the inside or median side and for the outside or shoulder side of paving lanes with two applicable longitudinal joints. Each paving layer will be measured independently at the time the mat is placed.

## E Payment

Add the following as 460.5.2.4 Pay Adjustment for HMA Pavement Longitudinal Joint Density:

- (1) The department will administer longitudinal joint density adjustments under the Incentive Density HMA Pavement Longitudinal Joints and Disincentive Density HMA Pavement Longitudinal Joints items. The department will adjust pay based on density relative to the specified targets in Section B of this special provision, and linear foot of the HMA Pavement bid item for that subplot as follows:

<b>PAY ADJUSTMENT FOR HMA PAVEMENT LONGITUDINAL JOINT DENSITY</b>	
<b>PERCENT SUBLOT DENSITY</b>	<b>PAY ADJUSTMENT PER LINEAR FOOT</b>
<b>ABOVE/BELOW SPECIFIED MINIMUM</b>	
Equal to or greater than +1.0 confined, +2.0 unconfined	\$0.20
From 0.0 to +0.9 confined, 0.0 to +1.9 unconfined	\$0
From -0.1 to -1.0	\$(0.20)
From -1.1 to -2.0	\$(0.40)
From -2.1 to -3.0	\$(0.80)
More than -3.0	<b>REMEDIAL ACTION<sup>[1]</sup></b>

<sup>[1]</sup> Remedial action must be approved by the engineer and agreed upon at the time of the pre-pave meeting and may include partial sublots as determined and defined in 460.3.3.2(7) of this document. If unacceptable material is removed and replaced per guidance by the engineer, the removal and replacement will be for the full lane width of the side of which the joint was constructed with unacceptable material.

- (2) The department will not assess joint density disincentives for pavement placed in cold weather because of a department-caused delay as specified in [standard spec 450.5.2\(3\)](#).
- (3) The department will not pay incentive on the longitudinal joint density if the traffic lane is in disincentive A disincentive may be applied for each mainline lane and all joint densities if both qualify for a pay reduction.
- (4) Inlay paving operations will limit payment for additional material to 2 inches wider than the final paving lane width at the centerline.

The department will pay incentive for longitudinal joint density under the following bid items:

ITEM NUMBER	DESCRIPTION	UNIT
460.2007	Incentive Density HMA Pavement Longitudinal Joints	DOL

The department will administer disincentives under the Disincentive Density HMA Pavement Longitudinal Joints administrative item.

## Appendix

### **WisDOT Longitudinal Joint – Nuclear Gauge Density Layout**

Each QC and QV density location must have a companion density location at any applicable joint. This companion location must share longitudinal stationing with each QC or QV density location and be located transversely with the center of the gauge 6-inches from the edge of the paving area.

For HMA Pavement Percent Within Limits QMP projects, this appears as follows:

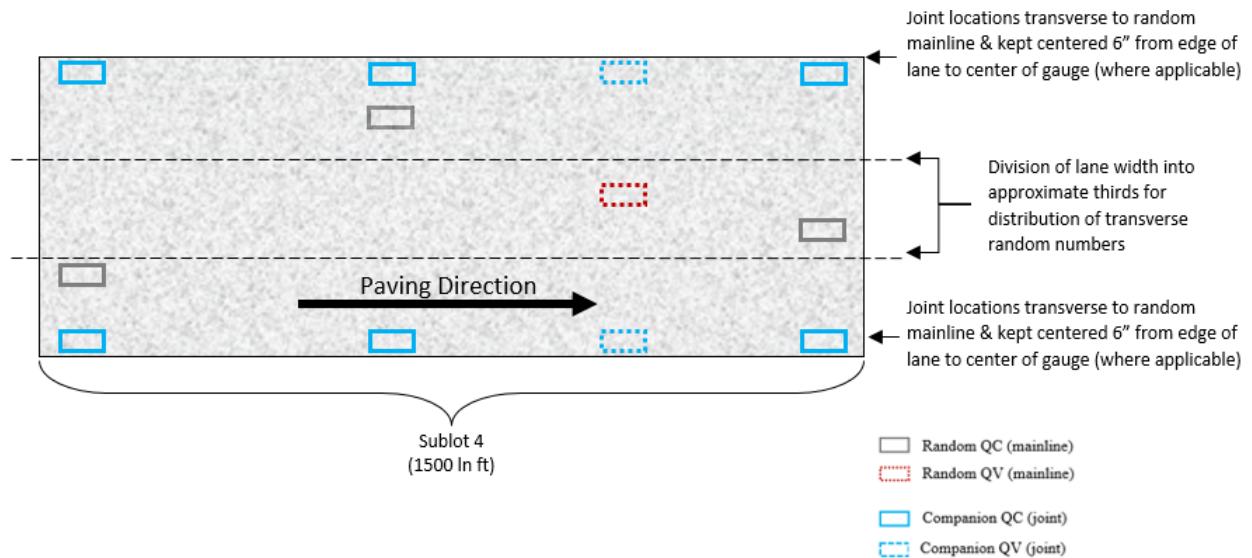

**Further Explanation of PAY ADJUSTMENT FOR HMA PAVEMENT LONGITUDINAL JOINT DENSITY Table**

	Confined				Pay Adjust
	Lower Layer (On Base)		Upper Layer		
	LT/MT	HT	LT/MT	HT	
Mainline Target (SS 460-3)	91.0	92.0	93.0	93.0	-
Confined Target (mainline - 1.5)	89.5	90.5	91.5	91.5	-
Equal to or greater than +1.0	≥ 90.5	≥ 91.5	≥ 92.5	≥ 92.5	\$0.20
From 0.0 to +0.9	90.4 - 89.5	91.4 - 90.5	92.4 - 91.5	92.4 - 91.5	\$0
From -0.1 to -1.0	89.4 - 88.5	90.4 - 89.5	91.4 - 90.5	91.4 - 90.5	(\$0.20)
From -1.1 to -2.0	88.4 - 87.5	89.4 - 88.5	90.4 - 89.5	90.4 - 89.5	(\$0.40)
From -2.1 to -3.0	87.4 - 86.5	88.4 - 87.5	89.4 - 88.5	89.4 - 88.5	(\$0.80)
More than -3.0	< 86.5	< 87.5	< 88.5	< 88.5	REMEDIAL ACTION

	Unconfined				Pay Adjust
	Lower Layer (On Base)		Upper Layer		
	LT/MT	HT	LT/MT	HT	
Mainline Target (SS 460-3)	91.0	92.0	93.0	93.0	-
Unconfined Target (Mainline -3.0)	88.0	89.0	90.0	90.0	-
Equal to or greater than +2.0	≥ 90.0	≥ 91.0	≥ 92.0	≥ 92.0	\$0.20
From 0.0 to +1.9	89.9 - 88.0	90.9 - 89.0	91.9 - 90.0	91.9 - 90.0	\$0
From -0.1 to -1.0	87.9 - 87.0	88.9 - 88.0	89.9 - 89.0	89.9 - 89.0	(\$0.20)
From -1.1 to -2.0	86.9 - 86.0	87.9 - 87.0	88.9 - 88.0	88.9 - 88.0	(\$0.40)
From -2.1 to -3.0	85.9 - 85.0	86.9 - 86.0	87.9 - 87.0	87.9 - 87.0	(\$0.80)
More than -3.0	< 85.0	< 86.0	< 87.0	< 87.0	REMEDIAL ACTION

stp-460-075 (20230629)

**40. Material Transfer Vehicle (1060-47-70), Item 460.9000.S.001.**

**A Description**

This special provision describes providing Material Transfer Vehicles (MTV) and operators for use during HMA upper layer paving operations of the travel lanes as shown in the plan or as directed by the engineer.

**B Materials**

Furnish a self-propelled MTV with the ability to remix, maintain constant temperature, and continually feed the paver hopper. MTV storage capacity shall be adequate to provide continuous forward movement of the paver. Coordinate paver speed to match the delivery of material and capacity of the MTV to minimize stopping of the paver.

**C Construction**

Ensure that an operator stays with the MTV at all times during moving operations. Keep the paver's hopper full at all times and the MTV's hopper filled such that the conveying augers are never exposed to avoid segregation of the material. Placement of HMA upper layer pavement in the travel lanes will not be allowed without the MTV. Tie ins of intersections, shoulders paved separately, and other non-travel lane areas will not require the use of the MTV.

**D Measurement**

The department will measure Material Transfer Vehicle once for the contract, acceptably completed, regardless the number of vehicles in use.

**E Payment**

The department will pay for measured quantities at the contract unit price under the following bid item:

ITEM NUMBER	DESCRIPTION	UNIT
460.9000.S.001	Material Transfer Vehicle (1060-47-70)	EACH

Payment is full compensation for furnishing all material transfer vehicles and operators.

stp-460-900 (20230113)

**41. Removing Bearings B-67-245, Item 506.7050.S.001.**

**A Description**

This special provision describes raising the girders and removing the existing bearings, as the plans show.

**B (Vacant)**

**C Construction**

Raise the structure's girders and remove the existing bearings as the plans show.

Obtain prior approval from the engineer for the method of jacking the girders and of supporting them as required.

**D Measurement**

The department will measure Removing Bearings B-67-245 by the unit for each bearing removed, acceptably completed.

**E Payment**

The department will pay for measured quantities at the contract unit price under the following bid item:

ITEM NUMBER	DESCRIPTION	UNIT
506.7050.S.001	Removing Bearings B-67-245	EACH

Payment is full compensation for raising the bridge girders; and for removing the old bearings.

Cost of furnishing and installing the bearings will be paid for under separate bid items.

stp-506-035 (20130615)

**42. Sawing Pavement Deck Preparation Areas, Item 509.0310.S.**

**A Description**

This special provision describes sawing around deteriorated areas requiring deck repairs under the Preparation Decks bid items on decks receiving asphalt or polymer overlays and for deck repairs that will not receive an overlay.

**B (Vacant)**

**C Construction**

The department will sound and mark areas of deteriorated concrete that require deck preparation. The engineer may identify and mark additional areas as the work is being performed.

Wet cut a minimum of 1 inch deep and at least 2 inches outside of the marked areas. Bound each marked area by providing cuts aligned parallel and perpendicular to the deck centerline.

Remove sawing sludge after completing each area. Do not allow sludge or resulting residue to enter a live lane of traffic, storm sewer, stream, lake, reservoir, marsh, or wetland. Dispose of sludge at an acceptable material disposal site located off the project limits or, if the engineer allows, within the project limits.

**D Measurement**

The department will measure Sawing Pavement Deck Preparation Areas by the linear foot, acceptably completed, measured as the total linear feet of bounding cuts.

The department will not measure for payment over-cuts or cuts made beyond what is required to bound engineer-marked deterioration limits.

**E Payment**

The department will pay for measured quantities at the contract unit price under the following bid item:

ITEM NUMBER	DESCRIPTION	UNIT
509.0310.S	Sawing Pavement Deck Preparation Areas	LF

Payment is full compensation for making all saw cuts; and for debris disposal.

stp-509-070 (20180628)

**43. Concrete Masonry Deck Repair, Item 509.2100.S.**

**A Description**

This special provision describes providing concrete masonry on the sawed deck preparation areas of the concrete bridge deck and in full depth deck, curb, and joint repair areas. Conform to standard spec 502 and standard spec 509.

**B Materials**

**B.1 Neat Cement**

Furnish a neat cement bonding grout. Mix the neat cement in a water-cement ratio approximately equal to 5 gallons of water per 94 pounds of cement.

**B.2 Concrete**

Furnish grade C or E concrete conforming to standard spec 501 for deck preparation, full-depth deck repair, curb repair and joint repair areas except as follows:

1. The contractor may increase slump of grade E concrete to 3 inches.
2. The contractor may use ready-mixed concrete.

Provide QMP for class II ancillary concrete as specified in standard spec 716.



## **C Construction**

### **C.1 Neat Cement**

Immediately before placing the concrete deck patching, coat the prepared surfaces with a neat cement mixture. Ensure the prepared concrete surfaces are moist without any standing water before coating with the neat cement mixture. Brush the neat cement mixture over the prepared concrete surfaces to ensure that all parts receive an even coating, and do not allow excess neat cement to collect in pockets. Apply the neat cement at a rate that ensures the cement does not dry out before being covered with the new concrete.

### **C.2 Placing Concrete**

Place concrete conforming to standard spec 509. As determined by the engineer, consolidate smaller areas by internal vibration, strike them off, and finish the areas with hand floats to produce plane surfaces that conform to the grade and elevation of the adjoining surfaces. Give all deck patching areas a final hand float finish.

### **C.3 Curing Concrete**

Cure the concrete masonry deck patching conforming to standard spec 502.2.6(1).

## **D Measurement**

The department will measure Concrete Masonry Deck Repair by the cubic yard, acceptably completed.

The department will measure concrete used in deck preparation areas and in full depth deck, curb, and joint repair as part of the Concrete Masonry Deck Repair bid item.

The department will not measure wasted concrete.

## **E Payment**

The department will pay for measured quantities at the contract unit price under the following bid item:

ITEM NUMBER	DESCRIPTION	UNIT
509.2100.S	Concrete Masonry Deck Repair	CY

Payment is full compensation for furnishing, hauling, preparing, placing, finishing, curing, and protecting all materials.

stp-509-060 (20210708)

## **44. Cleaning Parapets, Item 509.9050.S.**

### **A Description**

This special provision describes cleaning the inside faces and top surface of the concrete parapet as the plans show and as the engineer directs.

### **B (Vacant)**

## **C Construction**

### **C.1 Blast Cleaning Operation**

Blast clean the inside face and top surface of the concrete parapet according to SSPC SP-13 and ASTM D4259 for an abrasive blast cleaning to a surface roughness and finish as the engineer directs. Before abrasive blast cleaning operations are to begin for the entire bridge parapet, prepare a representative trial area on the parapet concrete surface, and have the method of blast cleaning approved by the engineer.

### **C.2 Water Cleaning Operation**

After abrasive blast cleaning operations are completed, clean the prepared parapet surface with water according to ASTM D4258. Remove with this water cleaning all dust and loose material from the parapet inside face and top that is to be coated with pigmented surface sealer. Provide an adequate drying time of the parapet inside face and top surface of at least 24 hours before coating with the pigmented surface sealer. Remove all loose concrete, dirt, dust, or blast material that remains on the bridge deck, as the engineer directs.

## D Measurement

The department will measure Cleaning Parapets in length by the linear foot of parapet, acceptably cleaned.

## E Payment

The department will pay for measured quantities at the contract unit price under the following bid item:

ITEM NUMBER	DESCRIPTION	UNIT
509.9050.S	Cleaning Parapets	LF

Payment is full compensation for abrasive blast cleaning; for water cleaning; and for all additional clean up of the concrete surface and surrounding bridge deck area.

stp-509-050 (20151210)

## 45. Culvert Pipe Liners 18-Inch, Item 520.9700.S.001; Cleaning Culvert Pipes for Liner Verification, Item 520.9750.S.

### A Description

This special provision describes providing, verifying, and pressure grouting culvert pipe liners for circular culverts.

### B Materials

#### B.1 General

Provide flow calculations at the preconstruction conference. Use contractor-proposed liner properties, the Manning's coefficients listed on the department's approved products list, and base calculations on existing culvert sizes and liner sizes the plans show. For host pipes use a maximum Manning's coefficient of 0.013 for concrete pipe and 0.024 for corrugated metal pipes. Ensure that pipes when lined have a capacity within  $\pm 5\%$  of the original full flow capacity of the pipe.

#### B.2 Flexible Pipe Liner

Use liners with a Manning's coefficient value published on the department's approved products list. Upon delivery provide manufacturer certificates of compliance certifying that the liners conform to the following:

Pipe Type	ASTM/AASHTO Designation	ASTM D3350 Resin
<b>High Density Polyethylene (HDPE)</b>		
Profile Wall Pipe	ASTM F894	345463C
Solid Wall Pipe	ASTM F714	345463C
<b>Polyvinylchloride (PVC)</b>	ASTM F949	---
<b>Steel Reinforced Polyethylene (SRPE)</b>	ASTM F2562 AASHTO M335 (12- to 60-in. Dia.) AASHTO MP40 (66- to 120-in. Dia.)	345463C

#### B.3 Grout

##### B.3.1 Cement

Furnish cement meeting the requirements of standard spec 501.2.4.1 for Type I or II Portland Cement.

##### B.3.2 Fly Ash

Furnish Class C or F Fly Ash meeting the requirements of standard spec 501.2.4.2.2.

##### B.3.3 Sand

Furnish natural sand meeting the fine aggregate requirements of standard spec 501.2.7.2 and the size requirements of standard spec 501.2.7 except the percent passing the number 200 sieve shall be 0-5 percent by weight.

### B.3.4 Water

Furnish water meeting the requirements of standard spec 501.2.6.

### B.3.5 Mix Design

Use the basic proportions of dry materials per cubic yard of grout as follows:

- Cement 100 pounds
- Fly Ash 400 pounds
- Fine Aggregate 2600 pounds

Air entraining and chemical admixtures to control fluidity of the grout are allowable. Ten days before placement, furnish to the engineer a design mix detailing all components and their proportions in the mix.

### B.3.6 Cellular Grout

Alternatively, the contractor may use, or if the manufacturer recommends, an engineer-approved commercial cellular concrete grout conforming to the following:

Cement	ASTM C150	Type I or II
Density	ASTM C495 (no oven drying)	50 pcf min
Compressive Strength	ASTM C495	300 psi @ 28 day min 100 psi in 24 hours
Shrinkage	ASTM	1% by volume
Flow	ASTM C939	35 sec max

## C Construction

### C.1 General

As soon as possible after contract execution, survey existing culvert pipes to determine which culverts need cleaning in order to verify the required liner diameter and length. Notify the engineer before cleaning to confirm payment under the Cleaning Culvert Pipes for Liner Verification bid item.

Coordinate with the engineer to field verify culvert diameter and length, shape, material, and condition before ordering the liners.

Obtain easements if necessary for installing long sections of pipe.

### C.2 Excavating and Cleaning

Before inserting the liner, clean and dry the pipe. Excavate and pump as required to remove debris and other materials that would interfere with the placement or support of the inserted liner. Dispose of and replace unserviceable endwalls as the engineer directs.

### C.3 Flow Diversion

Maintain drainage at and through worksite during construction according to standard spec 107.20, 205 and 520. Use existing culvert pipes, existing drainage channels, temporary culvert pipes, or temporary drainage channels to maintain existing surface and pipe drainage. Provide, operate, and maintain pumps to bypass flow or dewater during construction as necessary. Unless otherwise approved by the engineer, dewater by bypassing or diverting flow during bulkheading and grouting operations. Provide a plan for controlling flow and dewatering (including sediment treatment as required) as part of the project ECIP.

### C.4 Placing Liners

Unload liners using slings and boom-type trucks or equivalents. Do not use chains or wire rope to handle liners and do not dump liners from the trucks when unloading.

Install liners such that the alignment and invert lie true to the lines, grades, and elevations in the plan. In absence of plan details, install liners horizontally to provide even annular space between the host pipe and sides of the liner. Install liners vertically with the invert as close to the host pipe invert as possible.

Obtain additional easements, if necessary, for installing long sections of liner.

Connect joints and install the liner per the manufacturer's recommendations and this part.

## C.5 Pressure Grouting

Furnish a written plan for grouting the annular space between the host pipe and culvert pipe liner to the engineer for acceptance. Furnish the grouting plan prior to or at the project preconstruction conference so that it can be reviewed and discussed. At a minimum, the grouting plan shall consist of the following:

- Intended grout mix(es)
- Testing methods and frequency
- Pumping equipment and pressure regulation
- Intended grout staging
- Grout monitoring
- Bracing/floatation control

Include a description of staging in the grouting plan. Based on the length and slope of the host culvert, multiple stages may be required to minimize external loads on the culvert pipe liner. Develop the staging plan with the manufacturer based on the recommended maximum loading for the culvert pipe liner and the condition of the host culvert. Unless approved by the manufacturer, in no case shall a single lift of grout exceed 1/3rd the pipe external diameter at any point in the pour.

After the liner is in place, fill the area between the original culvert and the liner completely with grout per the accepted grouting plan. Block, grout in lifts, or otherwise secure liners to prevent floatation or deformation of the liner while grouting. Grout ports can be fabricated to allow placement of anti-floatation bracing or spacers.

Use a grout plant that is capable of accurately measuring, proportioning, mixing, and discharging by volume and at discharge pressures the liner manufacturer recommends. Do not exceed manufacturer-specified maximum pressures. Place grout in lifts to prevent exceeding maximum allowable pressures and to prevent floatation.

Use grout and witness ports to vent grouting and monitoring grouting progress. Plug ports as necessary as grout reaches them.

Do not remove any bracing inside of the liner until the grouting process is complete.

## C.6 Assembly, Floatation, and Deflection Mitigation

Damage or misalignment due to assembly, floatation, or deformation during grouting, or otherwise resulting from workmanship will be mitigated at the contractor's expense.

## C.7 Site Restoration

Replace pipe sections damaged or collapsed during installation or grouting operations. Restore the grade to its original or improved cross section. Dispose of waste material.

## D Measurement

The department will measure the Culvert Pipe Liners bid items by the linear foot measured in place for each culvert location, acceptably completed.

The department will measure Cleaning Culvert Pipes for Liner Verification as each culvert, acceptably cleaned. The department will only measure culverts the engineer approves for payment.

## E Payment

The department will pay for measured quantities at the contract unit price under the following bid item:

ITEM NUMBER	DESCRIPTION	UNIT
520.9700.S.001	Culvert Pipe Liners 18-Inch	LF
520.9750.S	Cleaning Culvert Pipes for Liner Verification	EACH

Payment for the Culvert Pipe Liners bid items is full compensation for providing pipe liners; obtaining easements; for excavation; for pumping to bypass flow, to clean pipes, for liner insertion or for grouting; for shoring and dewatering; for cleaning the existing pipe before liner installation; for pressure grouting; for replacing contractor-damaged pipe and endwalls; and for restoring the grade and disposing of waste materials.

The department will pay the contractor \$150 per cubic yard for grout required in excess of 110 percent of the theoretical quantity required to fill the space between the inside diameter of the existing pipe and the outside diameter of the liner.

Payment for Cleaning Culvert Pipes for Liner Verification is full compensation for cleaning required to verify liner length and diameter; for excavation; for pumping to bypass flow, to dewater, or to remove debris; and for disposing of waste material.

The department will pay separately for replacing unserviceable endwalls not rendered unserviceable by contractor operations under the appropriate contract endwall bid item, or absent the appropriate item as extra work.

stp-520-015 (20230113)

**46. Cable Barrier Type 1, Item 613.1100.S;  
Cable Barrier End Terminal Type 1, Item 613.1200.S.**

**A Description**

This special provision describes providing socketed high-tension TL-3 cable guard meeting the National Cooperative Highway Research Program (NCHRP) Report 350, Test Level 3.

**B Materials**

Provide a cable barrier system that is on the approved product list for the county in which the system will be installed.

Provide a calibrated tension gauge to each county for the specific system installed in each county.

Provide one copy of video training material on the proper maintenance techniques and recovery of vehicles to each county for the specific system installed in each county. At a minimum, this training is to address proper tension techniques, proper operation of calibrated tension gauge, proper repair techniques, and proper methods to remove vehicles entrapped in the cable barrier.

**B.1 Design Requirements**

Thirty days before installation provide the engineer with two sets of manufacturer prepared drawings, Wisconsin P.E. stamped calculations, documentation, notes, plan details, and construction specifications. Provide required information in a PDF format or other in electronic format that the department can review information.

Obtain prior approval from the Bureau of Project Development (Erik Emerson at (608) 266-2842) for all hardware substitutions before delivering the hardware on the project.

If soils information is not in the plan, contact Chris Zacharias at (414) 750-7955.

**C Construction**

Construct concrete as specified in standard spec 501.

Construct steel reinforcement as specified in standard spec 505.

Construct terminal units at each end of a run of cable guard as the plans show. The contractor may determine the location of anchors subject to the engineer's approval.

Tension the cable according to the manufacturer's recommendations at the time of installation, and then check and adjust approximately three weeks after installation. If system is not maintaining proper tension, adjust tension and return three weeks later. Provide engineer documentation of date, time, location, tension value, and who checked the tension for each barrier run.

Use only one-half the available adjustment in each turnbuckle or tension adjustment connection to achieve manufacturer's recommended tension values.

Manufacturer is to certify that the installation was done according to manufacturer's recommendations and the plan requirements. Provide this documentation to the engineer.

The engineer will allow the contractor to open the roadway to traffic or remove traffic control devices if concrete attains manufacturer's compressive strength. Without compressive strength information, the engineer may allow the contractor to remove traffic control devices after 14 equivalent curing days. Equivalent curing days are defined in standard spec 415.3.

## C.2 Survey Anchor Monitor Points

Obtain or calculate benchmark, alignment, horizontal and vertical control points. The engineer will furnish data for the horizontal and vertical control points, control point ties, and horizontal alignments.

Maintain neat, orderly, and complete survey notes, drawings, and computations used in establishing location of each cable anchor monitor point. Make the survey notes and computations available to the engineer within 24 hours, upon request, as the work progresses.

Locate each cable anchor monitor point to within 0.02 feet horizontally and 0.01 feet vertically.

Survey anchor monitor points after construction of cable barrier end terminal anchors, but before cables are tensioned. Provide paper and electronic copies of survey data to engineer before installing cables.

### D Measurement

The department will measure Cable Barrier Type 1 by the linear foot, acceptably completed, measured from terminal to terminal and rounded to the nearest linear foot.

The department will measure Cable Barrier End Terminal Type 1 as each individual terminal, acceptably completed.

### E Payment

The department will pay for measured quantities at the contract unit price under the following bid items:

ITEM NUMBER	DESCRIPTION	UNIT
613.1100.S	Cable Barrier Type 1	LF
613.1200.S	Cable Barrier End Terminal Type 1	EACH

Payment is full compensation for designing, providing, and surveying anchor monitoring points for cable barrier end terminal or cable barrier.

stp-613-010 (20210708)

## 47. Fence Safety, Item 616.0700.S.

### A Description

This special provision describes providing plastic fence at locations the plans show.

### B Materials

Furnish notched conventional metal "T" or "U" shaped fence posts.

Furnish fence fabric meeting the following requirements.

<b>Color:</b>	International orange (UV stabilized)
<b>Roll Height:</b>	4 feet
<b>Mesh Opening:</b>	1 inch min to 3 inch max
<b>Resin/Construction:</b>	High density polyethylene mesh
<b>Tensile Yield:</b>	Avg. 2000 lb per 4 ft. width (ASTM D638)
<b>Ultimate Tensile Strength:</b>	Avg. 3000 lb per 4 ft. width (ASTM D638)
<b>Elongation at Break (%):</b>	Greater than 100% (ASTM D638)
<b>Chemical Resistance:</b>	Inert to most chemicals and acids

### C Construction

Drive posts into the ground 12 to 18 inches. Space posts at 7 feet.

Use a minimum of three wire ties to secure the fence at each post. Weave tension wire through the top row of strands to provide a top stringer that prevents sagging.

Overlap two rolls at a post and secure with wire ties.

## D Measurement

The department will measure Fence Safety by the linear foot along the base of the fence, center-to-center of posts, acceptably completed.

## E Payment

The department will pay for measured quantities at the contract unit price under the following bid item:

ITEM NUMBER	DESCRIPTION	UNIT
616.0700.S	Fence Safety	LF

Payment is full compensation for furnishing and installing fence and posts; maintaining the fence and posts in satisfactory condition; and for removing and disposing of fence and posts at project completion.

stp-616-030 (20160607)

## 48. Topsoil and Salvaged Topsoil.

*Replace standard spec 625.2 (1) with the following:*

- (1) Topsoil consists of loam, sandy loam, silt loam, silty clay loam, or clay loam humus-bearing soils adapted to sustain plant life, and ensure the topsoil consists of the following:

Topsoil Requirements	Minimum Range	Maximum Range
pH	6.0	8.0
Organic Matter*	5%	20%
Clay	5%	30%
Silt	10%	70%
Sand	10%	70%

\*Organic matter determined by loss on ignition test of samples oven dried to constant weight at 212 F (100 C).

Add the following to standard spec 625.2:

- (3) Furnish material that is free from large roots, sticks, weeds, brush, stones, litter, and waste products.
- (4) Do not furnish surface soils from ditch bottoms, drained ponds, and eroded areas, or soils which are supporting growth of NR 40 listed plants and noxious weeds or other undesirable vegetation.

*Replace standard spec 625.3.3 (3) with the following:*

- (3) Ensure that for the upper 2 inches, 100 percent of the material passes a one-inch sieve and at least 90 percent passes the No. 10 sieve.

SER-625-001 (20221007)

## 49. Covering Signs.

*Replace standard spec 643.2.3.3(2) with the following:*

- (2) Ensure that covers are flat black, blank, and opaque.

*Add the following to standard spec 643.3.4.1 as paragraph four:*

- (4) If multiple messages on a single sign are required to be covered, minimize the number of holes created by covering the sign with a single rectangular shaped covering. Multiple coverings on a single sign are only permissible where necessary to avoid covering necessary content or as directed by the engineer. Submit sign covering plans to the engineer for single signs requiring multiple coverings 3 days before performing work. Obtain engineer approval before covering signs. Remove sign coverings before placing fixed message signs unless otherwise directed by the engineer.

sef-643-005 (20180104)

## 50. General Requirements for Electrical Work.

### General

*Add the following to standard spec 651, 652, 653, 654, 655, 656, 657 and 659.*

All the work necessary to comply with revisions to standards specifications mentioned herewith shall be incidental to associated pay items or to the project including coordination, materials, and labor. No additional payment shall be made to the contractor.

*Add the following to standard spec 651.2:*

### Wisconsin Department of Transportation

Materials indicated to be returned to the department shall be hauled to one of the following locations:

State Electrical Shop at 935 South 60th street, West Allis, as directed by Mr. Pat Stoetzel, tel. (414) 750-5306

Arrange pickups and deliveries 3 days in advance and during regular business hours (Monday – Thursday 7:00 AM to 3:45 PM).

*Add the following to standard spec 651.3.1:*

Any circuit that the contractor does not personally tag out at the disconnect shall be considered live and will be subject to being activated by another person with no notice to the contractor. Make tagouts with manufactured tags and endorse them with the date and the name of the contractor. Clear tagouts at the end of the workday. The department does not employ a load dispatcher and has no intent to do so. Each electrical worker is responsible for their own protection from automatic switching and from switching by others.

The plans show required disconnections of existing lighting circuits, most in the form of abandoning existing underground conductors in place. The contractor may need to mobilize several times per each existing lighting distribution center. The contractor is expected to build these costs into the various paid items for removals and installations.

*Add the following to standard spec 651.5:*

Work to disconnect and connect conductors will be incidental to the paid measurement of footage.

There will be no measurement for payment for abandoning conductors or removing conductors for scrap.

Work to disconnect and connect electrical system, splice through, or to connect conductors are incidental to the installation or removal of the freeway lighting pay items included in this contract. The department will not measure conductors or conduits that have been abandoned in place or removed for scrap. The department will allow, at the contractor's discretion, for the salvaging of conductors to be abandoned, if possible.

*Add the following to standard spec 652.3.1.4:*

Support conductors at the top of the vertical raceway or as close as practical if the vertical rise exceeds 40-feet. Provide additional supports as shown; in no case shall the distance between supports exceed that shown in Table 300.19(A) of the Wisconsin State Electric Code.

*Add the following to standard spec 653.3(1):*

This provision modifies the standard detail drawing for pull boxes and thereby both the standard items and SPV pay item for pull boxes. Lighting pull box covers shall read "LIGHTING".

*Add the following to standard spec 655.3.1:*

Wet location splices are not anticipated on this project and not shown in the plans. In the event that the Engineer allows wet location splices, make pull box splices with Engineer approved epoxy kit for the freeway lighting and should be incidental to the installation of pull box.

At each pull point or access point, indicate the line side bundle with a lap of blue tape. Conductors in poles and in pull boxes or other terminations shall be marked with a 6-inch long blue tape wrap to identify the set of conductors emanating from distribution center (feeder).



*Add the following to standard spec 655.3.7(4):*

Where two or more wire networks pass through a pull point, tag each circuit network (i.e. A/B/N and C/D/N) with approved all-weather tags.

*Add the following to standard spec 657.2:*

Non-breakaway poles (mounted on structures, concrete bases or behind noise wall barriers without transformer base), as well as at stems of sign bridges containing electrical wires are to be double nutted and contractor shall install galvanized rat screen enclosing the bottom of pole area; extra nuts and screen incidental.

*Add the following to standard spec 657.3.1 and 657.3.5:*

Corrosion protection measures described in standard spec 657.3.1 and 657.3.5 are invoked for breakaway transformer bases and aluminum light poles. The contractor shall avoid contact of dissimilar metals in erecting the pole on its foundation and/or breakaway device. Any concern of trapped moisture or potential corrosion cell shall be resolved to the satisfaction of the Engineer.

**Manufacturer's Warranty for LED luminaires:** The manufacturer shall warrant to the department that each complete luminaire (consisting of the housing, optical assembly, LED drivers, surge protection and wiring) will be free from defects in material and workmanship for ten (10) years from the date that the luminaire are put into service. Luminaires shall be installed within one year of manufacture.

If any luminaires fail to meet the above warranty, the department shall provide the manufacturer with a written notice of any defect within thirty (30) days after discovery of the defect. The manufacturer shall provide all materials, luminaires, replacement component parts, labor, and all incidentals necessary to restore the luminaire to a fully operational, installed condition.

**Submittal Requirements for LED luminaires:** Considering the rapid advancement in LED technology, the overall project construction and duration of construction, within 10 calendar days after contract execution, the contractor is responsible to coordinate the lead time for LED luminaires purchase and installation schedule with the Engineer and the department's Lighting Engineer, Eric Perea, at [eric.perea@dot.wi.gov](mailto:eric.perea@dot.wi.gov) or at (414) 750-0935 for freeway lighting system prior to order LED luminaires. The LED luminaires purchasing may be done during later stage of construction as directed by the department which shall not delay the construction.

*Add the following to standard spec 659.3:*

Provide and install/replace Plaques Light Pole on all poles located in the median at a mounting height of 6-inch above the highest adjacent safety barrier or obstruction.

*Add the following to standard spec 659.3.1:*

Contractor shall be responsible to provide adequate temporary roadway lighting during all the construction stages not shown on the temporary lighting plans, but which are necessitated by field conditions or by any construction phasing changes. Installation of temporary lighting not shown on temporary lighting plans shall be paid according to appropriate pay items included in this contract. Contractor shall be responsible to submit redline markup plans for any additional temporary lighting to the Engineer for approval prior to installation.

## **51. Distribution Center Maintenance.**

Remove debris, animal nests, the accumulation of dirt, etc., from inside and near the distribution center cabinet. Trim weeds, saplings, and brush a reasonable distance around, including a sufficient distance to ensure access to the meter, the fence gate, the cabinet door. Cap the conduits leading into the cabinet to prevent rodents and other vermin to enter. Work is incidental to the contract.

**52. Electrical Conduit.**

*Replace standard spec 652.5 (2) with the following:*

- (2) Payment for Conduit Rigid Metallic, Conduit Rigid Nonmetallic, Conduit Reinforced Thermosetting Resin, and Conduit Special bid items is full compensation for providing the conduit, conduit bodies, and fittings; for providing all conduit hangers, clips, attachments, and fittings used to support conduit on structures; for pull wires or ropes; for expansion fittings and caps; for making necessary connections into existing pull boxes; for excavating, bedding, and backfilling, including any sand, concrete, or other required materials; for disposing of surplus materials; and for making inspections.

*Replace standard spec 652.5 (5) with the following:*

- (5) Payment for Conduit Loop Detector is full compensation for providing all materials, including conduit, compacted backfill, surface sealer if required, pull wire if required, condulets, conduit fittings, and for making necessary connections into existing pull boxes.

**53. Install Conduit into Existing Item, Item 652.0700.S.**

**A Description**

This special provision describes installing proposed conduits into an existing manhole, pull box, junction box, communication vault, or other structure.

**B Materials**

Use conduits, as provided and paid for under other items in this contract. Furnish backfill material, topsoil, fertilizer, seed, and mulch conforming to the standard spec.

**C Construction**

Expose the outside of the existing structure without disturbing existing conduits or cabling. Drill the appropriate sized hole, or holes, for entering conduits at a location within the structure without disturbing the existing cabling and without hindering the installation of new cabling within the installed conduit. Fill void area between the respective drilled hole and conduit with an engineer-approved filling material to protect against conduit movement and entry of fill material into the structure. Tamp backfill into place.

**D Measurement**

The department will measure Install Conduit into Existing System by the unit, acceptably installed. Up to five conduits entering a structure per entry point into the existing structure will be considered a single unit. Conduits in excess of five, or conduits entering at significantly different entry points into the existing pull box, manhole, or junction box will constitute multiple units of payment.

**E Payment**

The department will pay for measured quantities at the contract unit price under the following bid item:

ITEM NUMBER	DESCRIPTION	UNIT
652.0700.S	Install Conduit into Existing Item	EACH

Payment is full compensation for excavating, drilling holes; furnishing and installing all materials, including bricks, coarse aggregate, sand, bedding, and backfill; for excavating and backfilling; and for furnishing and placing topsoil, fertilizer, seed, and mulch in disturbed areas; for properly disposing of surplus materials; and for making inspections.

stp-652-070 (20230629)

**54. Electrical Service Meter Breaker Pedestal STH 318 & Silvernail Road, Item 656.0201.041; Electrical Service Meter Breaker Pedestal IH 94 EB Ramps & STH 318, Item 656.0201.051; Electrical Service Meter Breaker Pedestal IH 94 WB Ramps & STH 318, Item 656.0201.061; Electrical Service Meter Breaker Pedestal IH 94 EB Ramps & CTH T, Item 656.0201.071; Electrical Service Meter Breaker Pedestal IH 94 WB Ramps & CTH T, Item 656.0201.081; Electrical Service Meter Breaker Pedestal MBDMS670040, Item 656.0201.300; Electrical Service Meter Breaker Pedestal MBCCTV670244, Item 656.0201.301.**

*Append standard spec 656.2.3 with the following:*

- (2) The department will be responsible for the electrical service installation request for any department-maintained facility. Notify the maintaining authority if the signal is not state maintained that it is their responsibility to arrange for the electrical service installation.
- (3) Electrical utility company service installation and energy cost will be billed to and paid for by the maintaining authority.
- (4) Install the cabinet base and meter breaker pedestal first, so the electrical utility company can install the service lateral. Install a 3" conduit from the point of service from the utility to the meter breaker pedestal. Finish grade the service trench, replace topsoil that is lost or contaminated with other materials, fertilize, seed, and mulch all areas that are disturbed by the electrical utility company.

*Append standard spec 656.5 with the following:*

- (8) Payment is full compensation for grading the service trench; replacing topsoil; and for fertilizing, seeding, and mulching to restore the disturbed area of the service trench.

## **55. Signal Housings.**

*Replace standard spec 658.2(4) with the following:*

- (4) For pedestrian signal faces: furnish polycarbonate resin housings, doors, and visors. Use yellow, Federal Standard 595 - FS13538, housings and dull black door faces and visors. For 16-inch heads, mount a z-crate visor and gasket to the door with stainless steel tabs. Drill the housing for top and bottom pipe mounting with the ability to rotate 270 degrees on the poly mounting brackets.

## **56. Pedestrian Push Buttons.**

*Replace standard spec 658.2(5) with the following:*

- (5) For pedestrian push buttons: furnish freeze-proof ADA compliant pedestrian push buttons made by a department-approved manufacturer. The contractor shall place a Size 1, Type H reflective (R10-3EL, R, D) sign sticker (per state sign plate), message series – B directly above each push button. Include a directional arrow or arrows on the sign as the plans show.

## **57. Traffic Signal Faces & Pedestrian Signal Face 16-Inch.**

*Append standard spec 658.3(5) with the following:*

- (5) Connect all ungrounded conductors with wire nuts in the appropriate sections of the signal heads. Be certain to twist wires prior to installing the wire nuts. All wire nuts must be installed facing up to prevent the entrance of water.

## **58. Lamp, Ballast, LED, Switch Disposal by Contractor, Item 659.5000.S.**

### **A Description**

This special provision describes the detachment and packaging of lamps, ballasts, LEDs, and mercury containing switches (e.g., overhead roadway lighting, underdeck bridge, wall packs, pedestrian signals, traffic control stop lights and warning flashers, fluorescent bulbs, and thermostats) removed under this contract for disposal as hazardous materials.

For Lamp, Ballast, LED, Switch Disposal by Contractor, coordinate removal from the work site by the department's hazardous waste disposal vendor. Disposal will be billed to the department by the hazardous waste disposal vendor.

## **B Materials**

### **B.1 Disposal by Contractor**

Items removed under this contract will be considered the property of the department for waste generator identification. The contractor is responsible for coordinating with the department's hazardous waste vendor for disposal:

<https://wisconsin.gov/Documents/doing-bus/eng-consultants/cnslt-rsrces/environment/hazwaste-contacts.pdf>

## **C Construction**

### **C.1 Removal**

Arrange for the de-energizing of luminaires after receiving approval from the engineer that the existing luminaires can be removed. Do not remove luminaires that cannot be replaced with proposed LED units and operational within the same workday. The new LED units need to be operational prior to sunset of the same workday.

Detach and remove luminaires and lamps from the existing traffic signal poles or respective structure. Avoid breaking fixtures whenever possible.

Lamps, ballasts, LED, and switches will become property of the department, and will be disposed of in an environmentally sound manner.

### **C.2 Packaging of Hazardous Materials**

Provide a secure, level location removed from the travelled way for storage of the material for disposal.

Pack intact fixtures in the packaging of the new lamps used to replace them, or packaging affording the equivalent protection. Place in full, closed stackable cartons.

Pile cartons no more than four high if palletized and secure cartons with shrink wrap to prevent shifting or falling of the loads. Clearly mark each pallet with the words "Universal Waste Lamps" or "Universal Waste Ballasts", the date, and the number of fixtures on each pallet.

Pack broken fixtures into (min.) 6 mil thick plastic bags and place inside sturdy cardboard boxes or the equivalent. Mark the outer packaging with the term "Broken Fixtures/Lamps", the date and the number of broken fixtures clearly marked on the box.

The hazardous waste vendor will not accept fixtures improperly packaged. The vendor will reject any fixtures not removed as part of a contract pay item or otherwise required under this contract.

Pack ballasts and mercury containing switches in appropriate containers.

### **C.3 Disposal by Contractor**

Complete the lamp and ballast inventory (<https://wisconsin.gov/Documents/doing-bus/eng-consultants/cnslt-rsrces/environment/dotlampballastinventory.dotx>) and contact the hazardous waste vendor to coordinate pickup and disposal at a location specified by the contractor. Consolidate all pallets and boxes from one project at a single location. Contact the hazardous waste vendor to set up an appointment for pickup. The hazardous waste vendor requires a minimum of one week advance notice to schedule pickup.

## **D Measurement**

The department will measure Lamp, Ballast, LED, Switch Disposal by Contractor as each individual unit removed and received by the hazardous waste vendor, properly packaged and acceptably completed, matching the total number of units provided on the inventory form. The department will not measure broken fixtures that exceed a total of 10 percent of all fixtures to be disposed.

## **E Payment**

The department will pay for measured quantities at the contract unit price under the following bid item:

ITEM NUMBER	DESCRIPTION	UNIT
659.5000.S	Lamp, Ballast, LED, Switch Disposal by Contractor	EACH

Payment for Lamp, Ballast, LED, Switch Disposal by Contractor is full compensation for detachment, handling, packaging, labeling and scheduling disposal with the hazardous waste vendor; and scrapping and disposal of all other materials.

stp-659-500 (20220628)

- 59. Temporary Traffic Signals for Intersections STH 318 & Silvernail Road, Item 661.0201.041;  
Temporary Traffic Signals for Intersections IH 94 EB Ramps & STH 318, Item  
661.0201.051;  
Temporary Traffic Signals for Intersections IH 94 WB Ramps & STH 318, Item  
661.0201.061;  
Temporary Traffic Signals for Intersections IH 94 EB Ramps & CTH T, Item 661.0201.071;  
Temporary Traffic Signals for Intersections IH 94 WB Ramps & CTH T, Item 661.0201.081.**

*Replace standard spec 661.2.1(1) with the following:*

- (1) Furnish control cabinet and control equipment. The department will supply, maintain, and install a signal controller, cellular modem, and ethernet switch to establish remote communication to the signal controller. The cabinet must be equipped with a 6-circuit Isotel independent of the GFI receptacles. Provide a cabinet with a Corbin #2 door lock and an access door that allows placing the controller in emergency flash. Provide keys to the access door to the engineer and law enforcement agencies as required. Also provide a manual control accessible by the police. Test traffic signal control cabinets before installation. The department will provide the signal controller with the initial traffic signal timing, and the department will be responsible for all subsequent signal timing changes.

*Replace standard spec 661.2.1(3) with the following:*

- (3) Use existing underground electric service and meter breaker pedestal for the operation of the Temporary Traffic Signal at the intersections of STH 318 & Silvernail Rd, IH 94 EB Ramps & STH 318, IH 94 WB Ramps & STH 318, IH 94 EB Ramps & CTH T, and IH 94 WB Ramps & CTH T. Contact Jarrett Gates at (262) 548-5894 to coordinate the temporary electrical service. The department will pay for all installation and Energy Costs associated with the operation of the Temporary Traffic Signals. It is the contractor's responsibility to contact the electrical utility as it pertains to the affidavit and site ready card to arrange timely installation of the temporary service. If the control cabinet is not mounted on the electrical service pole, add a second electrical service disconnect to the outside of the control cabinet for the convenience of emergency personnel.

Furnish and install a generator to operate the temporary traffic signals for the times required to switch the existing permanent traffic signal over to the temporary traffic signal and for the time required to switch the temporary traffic signal back over to the permanent traffic signal.

Contact the local electrical utility at least four days prior to making the switch from the Temporary Traffic Signal to the new Permanent Traffic Signal.

*Append standard spec 661.2.1(6) with the following:*

- (6) Control equipment or controller equipment is defined as anything inside the control cabinet excluding the department furnished signal controller, cellular modem, and ethernet switch.

*Replace standard spec 661.3.1(2) with the following:*

- (2) Request a signal inspection of the completed temporary traffic signal installation to the engineer at least five working days prior to the time of the requested inspection. Notify the SE Region Electrical Field Unit at (414) 266-1170 to coordinate the inspection. The SE Region electrical personnel will perform the inspection.

*Append standard spec 661.3.1.4(4) with the following:*

- (4) Arrange for every other week inspections with the engineer to check the height of the span wire above the roadways to ensure that the bottom of the traffic signal heads remain within the minimum and maximum heights allowed above the roadway. Make all height adjustments within 1-hour of an inspection indicating that adjustments are required. Notify the engineer in writing upon completion of all necessary adjustments. Maintain a written log to properly document the date of each every other week inspection, the heights above the roadway, the roadway clearance after adjustments have been made, and acceptance by the engineer. Provide all documentation related to the every other week span wire height checks as well as all records related to maintenance performed on the temporary traffic signal installations to the engineer.

*Replace standard spec 661.3.2.6(2) with the following:*

- (2) Upon acceptance of new signal and completion of work, the department will switch control of the intersection over to the permanent cabinet installation. Remove signal cable and wires, wood poles, wood posts, control cabinet, control equipment, and incidental materials. Upon deactivation of the controller, call the electrical utility immediately for the temporary electrical service disconnect. The department shall remove the signal controller, cellular modem, and ethernet switch.

*Replace standard spec 661.3.2.7(2) with the following:*

- (2) Respond within one hour of notification to provide corrective action to any emergency such as but not limited to knockdowns, signal cable problems, and controller equipment failures. If equipment becomes damaged or faulty beyond repair, replace it within one working day. In order to fulfill this requirement, maintain, in stock, sufficient materials and equipment to provide repairs. Replace the traffic signal control equipment including the cabinet and cabinet accessories within 4 hours. If the outcome of the response identifies damage to the department furnished signal controller, notify the Traffic Management Center at (800) 375-7302 who will then dispatch the SE Region Electrical Field Unit.

*Replace standard spec 661.5(2) with the following:*

- (2) Payment for the Temporary Traffic Signals for Intersections bid item is full compensation for providing, maintaining, and repairing the complete temporary installation; and for removal. Payment also includes the following:
  1. Furnishing and installing replacement equipment.
  2. The cost of delivery and pick-up of the cabinet assemblies.

Payment is full compensation for drilling holes; furnishing and installing all materials, including bricks, and coarse aggregate; for excavation, bedding, and backfilling, including any sand or other required materials; furnishing and placing topsoil, fertilizer, seed, and mulch in disturbed areas; for properly disposing of surplus materials; for making inspections; and for cleaning up and properly disposing of waste.

## **60. Ramp Closure Gates 40-FT, Item 662.1040.S.**

### **A Description**

This special provision describes providing freeway on-ramp closure gates on type 5 steel luminaire poles.

### **B Materials**

#### **B.1 General**

Provide five user manuals and a listing of vendors and contact information for each manufactured component including flasher electrical components.

The engineer may allow alternates equal to specified manufactured components. The engineer may require plan detail modifications to accommodate alternates. The engineer may accept alternate arms or mounting adaptors only if the contractor can demonstrate that the department can easily remove and replace the arms.

#### **B.2 Components**

Furnish type 5 steel poles designed to carry twin 15-foot luminaire arms and conforming to standard spec 657 and with dimensions for acceptable installation of the ramp gate hardware as shown on the detail. Ensure a contiguous pole by eliminating the hand hole near base of pole, thus allowing uninhibited mounting of the gate pivot assembly.

Furnish galvanized steel nuts and bolts conforming to ASTM A307 except where designated as high strength (HS), conform to ASTM F3125. For the ramp closure gate locking mechanism, furnish a 3/4-inch handle nut.

Furnish grade A36 steel for the gate supports, gate pivot assembly, and associated hardware galvanized after fabrication by either a mechanical or hot-dip process. Grind welded connections, rough edges, and burrs smooth before galvanizing to ensure a finished appearance. Ensure that the galvanized coating conforms to ASTM A 153.

Provide aluminum/fiberglass gate arms of the nominal length the bid item indicates and conforming to plan dimensions. Cover gate arms on two sides with alternating red and white shop-applied type H reflective from the department's approved products list. Also provide a shear pin base that is the manufacturer's "permanent pivot" style. Obtain components from:

B&B Roadway  
15191 Hwy 243  
Russellville, AL 35654  
Tel: (888) 560-2060  
Gate arm: Model MU605

Furnish a worm gear winch with a single line vertical lift capacity of 2000 lbs. Ensure that the winch has hardened steel gears, a handgrip, permanently lubricated bearings, a reinforced arc-welded reel assembly, and mounting plate. Ensure that the winch can be mounted to the winch mount plate shown on the construction details and the handgrip can be operated without conflict with the pole or ramp gate assembly. Furnish a 2-inch outdoor rated, rot resistant polyester strap for the connection between the worm gear winch and the gate arm pivot assembly.

### **C Construction**

Provide ramp closure gate at the locations the plans show. Apply marine grade anti seize compound to all bolt threads and to the interface between the aluminum base and steel pole. The engineer may direct adjustment of the gate arm assembly to ensure the correct vertical and angular orientation of the completed closure gate.

Install structure identification plaques in the location the plan details show.

### **D Measurement**

The department will measure the Ramp Closure Gates bid items as each individual installation, acceptably completed.

### **E Payment**

The department will pay for measured quantities at the contract unit price under the following bid item:

ITEM NUMBER	DESCRIPTION	UNIT
662.1040.S	Ramp Closure Gates 40-FT	EACH

Payment for the Ramp Closure Gate bid items is full compensation for providing ramp closure gates including support poles; for gate arm assemblies including guides, collars, and gate arms; and for structure identification plaques.

stp-662-005 (20191121)

## **61. Ramp Closure Barricade Rack 2-Unit, Item 662.6020.S; Ramp Closure Barricade Rack 3-Unit, Item 662.6030.S.**

### **A Description**

This special provision describes providing storage racks for barricades used to temporarily close off entrance ramps to divided highways.

### **B Materials**

Furnish wooden posts conforming to standard spec 634.2.1.

Fabricate tubular steel components using structural quality 12-gauge strip steel conforming to ASTM designation A1011, grade 50 with an average minimum yield strength, after cold-forming, of 55,000 psi. The contractor may use perforated tubing.

Hot dip galvanize each tube according to ASTM A653 grade 90. Treat corner welds and cut ends with cold-galvanized organic zinc paint as manufacturer recommends.

Furnish galvanized bolts, nuts, and washers zinc-coated according to ASTM A153.

### C Construction

Install wood posts conforming to standard spec 634.3.1 and the plan details. Fabricate and install tubular steel components as the plans show.

### D Measurement

The department will measure the Ramp Closure Barricade Rack bid items as each individual barricade rack, acceptably completed.

### E Payment

The department will pay for measured quantities at the contract unit price under the following bid items:

ITEM NUMBER	DESCRIPTION	UNIT
662.6020.S	Ramp Closure Barricade Rack 2-Unit	EACH
662.6030.S	Ramp Closure Barricade Rack 3-Unit	EACH

Payment is full compensation for providing barricade racks; for wood posts; and for galvanized tubular steel components and hardware.

stp-662-015 (20130615)

## 62. Intelligent Transportation Systems (ITS) – Control of Materials.

### Standard spec 106.2 – Supply Source and Quality

*Add the following to standard spec 106.2:*

The department will furnish a portion of equipment to be installed by the contractor. This department-furnished equipment includes the following:

Department-Furnished Items
Microwave Vehicle Detectors
6-Count Fiber Optic Cable
Fiber Optic Termination Panels
Fiber Optic Splice Enclosures
CCTV Cameras
CCTV Camera Pole and Anchor Bolts
Ethernet Switches
Terminal Server
Pole-Mounted Cabinets
Dynamic Message Sign

Pick up small department-furnished equipment, such as communications devices, cameras, and controllers, from the department's Traffic Management Center (TMC), 433 W. St. Paul Ave., Milwaukee, WI 53203 at a mutually agreed upon time during normal state office hours. Contact the Statewide ITS Engineer, Dean Beekman at (414) 227-2154 to coordinate pick-up of equipment.

Pick up cabinets and solar power systems, including batteries, at the department's TMC equipment storage facility at 633 W. Wisconsin Ave., Milwaukee, WI 53203 at a mutually agreed upon time during normal state office hours. Contact Dean Beekman to coordinate pick-up of equipment.

Large department-furnished equipment, such as camera poles and dynamic message signs will be delivered by the supplier to a contractor-controlled site identified by the contractor. Delivery will not necessarily be in a "just in time" manner. Store the equipment until field installation.

Within two weeks of Notice to Proceed, contact the engineer and Dean Beekman. Provide the address and contact information for the contractor-controlled location for delivery and the desired delivery schedule for the large state-furnished materials.

Transportation of the equipment between the electric shop and the field or interim locations are the responsibility of the contractor.



## **Standard spec 106.3 – Approval of Materials**

*Add the following to standard spec 106.3:*

### **Design/Shop Drawings**

Before the purchase and/or fabrication of any of the components listed herein, and for any non-catalog item shown on the Material and Equipment List specified above, and no more than 30 days after notice to proceed, submit five copies of design drawings and shop drawings, as required, to the department for review. The items and the drawings that represent them shall meet the requirements of the standard specifications.

Design drawing submissions shall consist of signed and certified designs, design drawings, calculations, and material specifications for required items.

Shop drawings will be required for, but not limited to the following:

1. Mounting assemblies for the vehicle speed and classification sensors, including their attachment to the structure.
2. Mounting LED warning signs to the sign structure.
3. Mounting detail for dynamic message signs.
4. Any contractor-designed structure or foundation.

The department will complete its review of the material within 30 days from the date of receipt of the submission, unless otherwise specified. The department will advise the contractor, in writing, as to the acceptability of the material submitted. The department may determine that if no exceptions were taken for the item, it is approved, and no further action is required by the contractor; or the item may be partially or totally rejected, in which case modify and/or amend the submittal as required by the department and resubmit the item within 14 days. At this time, the review and approval cycle described above will begin again.

stp-670-005 (20230629)

## **63. Intelligent Transportation Systems - General Requirements.**

### **A Description**

#### **A.1 General**

This special provision describes providing elements for an Intelligent Transportation System (ITS) in or along the existing roadway as the plans show.

Unusual aspects of this project include:

1. The project includes working on cables and equipment that are carrying data between roadside equipment and the department's Traffic Management Center (TMC). Interruption of this service is not expected to perform this work. If an interruption is determined necessary, it must be done on a weekend, and must be done in a way that minimizes communication outages for the existing equipment. Notify the department's TMC at least 48 hours in advance of the planned interruption.
2. The department will furnish some of the equipment to be installed. Make a reasonable effort to discover defects in that equipment before installing it.

#### **A.2 Surge Protection**

Equip every ungrounded conductor wire entering or leaving any equipment cabinet with a surge protector. For purposes of this section, multiple cabinets on a single pole or foundation are considered a single cabinet.

### **B Materials**

#### **B.1 General**

Only furnish equipment and component parts for this work that are new and have high quality workmanship. All controls, indicators, and connectors shall be clearly and permanently labeled in a manner approved by the engineer. All equipment of each type shall be identical.

All electrical equipment shall conform to the standards and requirements of the Wisconsin Electrical Code, the National Electrical Manufacturers Association (NEMA), National Electric Safety Council (NESC), Underwriter's Laboratory Inc. (UL) or the Electronic Industries Association (EIA), when applicable. All materials and workmanship shall conform to the requirements of the National Electrical

Code (NEC), Rural Electrification Administration (REA), Standards of the American Society for Testing and Materials (ASTM), American Association of State Highway and Transportation Officials (AASHTO), requirements of the plans, these special provisions, the standard specifications, and to any other codes, standards, or ordinances that may apply. All system wiring, conduit, grounding hardware and circuit breakers shall be in conformance with the National Electrical Code. Whenever reference is made to any of the standards mentioned, the reference shall be considered to mean the code, ordinance, or standard that is in effect at the time of the bid advertisement.

## **B.2 Outdoor Equipment**

All conductive connectors, pins (except pins connected by soldering), and socket contacts shall be gold plated. Acrylic conformal coating shall protect each circuit board side that has conductive traces. Except for integrated circuits containing custom firmware, all components shall be soldered to the printed circuit board.

To prevent galvanic corrosion, all connections between dissimilar metals shall incorporate a means of keeping moisture out of the connection. Where the connection need not conduct electricity, interpose a non-absorbing, inert material or washer between the dissimilar metals. Use nonconductive liners and washers to insulate fasteners from dissimilar metals. Where the connection must conduct electricity, use a conductive sealant between the dissimilar metals. Alternatively, use an insulating gasket and a bond wire connecting the two metal parts.

## **B.3 Custom Equipment**

Equipment that is not part of the manufacturer's standard product line, or that is made or modified specifically for this project, shall conform to the following requirements:

Where practical, electronics shall be modular plug-in assemblies to facilitate maintenance. Such assemblies shall be keyed to prevent incorrect insertion of modules into sockets.

All components shall be available from multiple manufacturers as part of the manufacturers' standard product lines. All must be clearly labeled with the value, part number, tolerance, or other information sufficient to enable a technician to order an exact replacement part.

Lamps used for indicator purposes shall be light-emitting diodes.

The printed circuit boards shall be composed of "two-ounce" copper on 1/16 inch thick fiberglass epoxy or equivalent type construction. Holes that carry electrical connections from one side of the boards to the other shall be completely plated through. Multilayer printed circuit boards shall not be used. The name or reference number used for the board in the drawings and maintenance manuals supplied to the department shall be permanently affixed to each board.

All components shall be mounted so that the identifying markings are visible without moving or removing any part, if practical.

## **B.4 Environmental Conditions**

Equipment shall continue to operate as specified under the following ranges of environmental conditions, except as noted in the specifications for individual pieces of equipment.

1. **Vibration and Shock:** Vehicle speed and classification sensors and any other equipment mounted atop poles or on structures shall not be impaired by the continuous vibration caused by winds (up to 90 mph with a 30 percent gust factor) and traffic.
2. **Duty Cycle:** Continuous
3. **Electromagnetic Radiation:** The equipment shall not be impaired by ambient electrical or magnetic fields, such as those caused by power lines, transformers, and motors. The equipment shall not radiate signals that adversely affect other equipment.
4. **Electrical Power:**
  - 4.1. **Operating power:** The equipment shall operate on 120-volts, 60-Hz, single-phase unless otherwise specified. It shall conform to its specified performance requirements when the input voltage varies from 89 to 135 volts and the frequency varies +3 Hz.
  - 4.2. **High frequency interference:** The equipment operation shall be unaffected by power supply voltage spikes of up to 150 volts in amplitude and 10 microseconds duration.
  - 4.3. **Line voltage transients:** The equipment operation shall be unaffected by voltage transients of plus or minus 20 percent of nominal line voltage for a maximum duration of 50 milliseconds. Equipment in the field shall meet the power service transient requirements of NEMA Standard TS-2 when connected to the surge protectors in the cabinets.

## 5. Temperature and Humidity:

- 5.1. **Field equipment:** Equipment in the field shall meet the temperature and humidity requirements of NEMA Standard TS-2. Liquid crystal displays shall be undamaged by temperatures as high as 165 degrees F, and shall produce a usable display at temperatures up to 120 degrees F.
- 5.2. **Equipment in Controlled Environments:** shall operate normally at any combination of temperatures between 50 degrees F and 100 degrees F, and humidity's between 5 percent and 90 percent, non-condensing, and with a temperature gradient of 9 degrees F per hour.

### B.5 Patch Cables and Wiring

All cables and wiring between devices installed in a single cabinet, or in separate cabinets sharing a single concrete base, will be considered incidental to the installation of the devices and no separate payment will be made for them. It is anticipated that this will include fiber optic patch cables between termination panels and Ethernet switches, 10 / 100 MBPS Ethernet cables, RS-232 cables between individual devices and terminal servers, and power cables between individual devices and power sources within the cabinets.

### B.6 Surge Protection

Low-voltage signal pairs, including twisted pair communication cable entering each cabinet shall be protected by two-stage, plug-in surge protectors and shall be installed on both ends of camera control cables. The protectors shall meet or exceed the following minimum requirements:

1. The protectors shall suppress a peak surge current of up to 10k amps.
2. The protectors shall have a response time less than one nanosecond.
3. The protector shall clamp the voltage between the two wires at a voltage that is no more than twice the peak signal voltage and clamp the voltage between each wire and ground at 50 volts.
4. The first stage of protection shall be a three-element gas discharge tube, and the second stage shall consist of silicon clamping devices.
5. The protector shall also contain a resettable fuse (PTC) to protect against excessive current.
6. There shall be no more than two pairs per protector.
7. It shall be possible to replace the protector without using tools.

Cables carrying power to curve signs shall be protected at the cabinet by grounded metal oxide varistors of appropriate voltages. The varistors must be at least 0.8 inch in diameter.

## C Construction

### C.1 Thread Protection

Provide rust, corrosion, and anti-seize protection at all thread assemblies of metallic parts by coating (non-spray) the mating surfaces with an approved compound. Failure to use an approved compound will result in no payment for the items to which coating was to have been applied.

### C.2 Cable Installation

When installing new cables into conduits containing existing cables, remove the existing cables and reinstall the existing cables simultaneously with the new cables. Take every precaution necessary to protect the existing cables. In the event of avoidable damage to the existing cables, replace all damaged cables, in-kind, at no additional expense to the department. When cables are pulled into conduit, use a cable pulling lubricant approved by the cable manufacturer. Submit documentation supporting manufacturer approval of the lubricant to the engineer.

### C.3 Wiring

Every conductor, except a conductor contained entirely within a single piece of equipment, must terminate either in a connector or on a terminal block. Provide and install the connectors and terminal blocks where needed, without separate payment. Use approved splice kits instead of connectors and terminal blocks for underground power cable splices.

Permanently label and key connectors to preclude improper connection. Obtain prior engineer approval for labeling methods before use.

Terminal blocks must be affixed to panels that permanently identify the block and what wire connects to each terminal. This may be accomplished by silk screening or by installing a laminated printed card under the terminal block, with the labels on portions of the card that extend beyond the block. Installation of terminal blocks by drilling holes in the exterior wall of the cabinet is not acceptable.

Use barriers to protect personnel from accidental contact with all dangerous voltages.

Do not install conductors carrying AC power in the same wiring harness as conductors carrying control or communication signals.

Arrange wiring, including fiber optic pigtails, so that any removable assembly can be removed without disturbing wiring that is not associated with the assembly being removed.

Communication and control cables may not be spliced underground, except where indicated on the plans.

Cables in the Traffic Management Center (TMC) or in communication hubs, which are not contained within a single cabinet, shall have at least 10 feet of slack.

#### **C.4 System Operations**

If the contractor's operations unexpectedly interrupt Intelligent Transportation Systems (ITS) service, notify the engineer immediately and restore service within 24 hours. Repair all damaged facilities to the condition existing before the interruption. If service is not restored within 24 hours, the department may restore service to any operating device and deduct restoration costs from payments due the contractor.

#### **C.5 Surge Protection**

Arrange the equipment and cabinet wiring to minimize the distance between each conductor's point of entry and its protector. Locate the protector as far as possible from electronic equipment. Ensure that all wiring between the surge protectors and the point of entry is free from sharp bends.

#### **D Measurement**

The department will not measure the work performed under this special provision.

#### **E Payment**

The department will pay for the work performed under this special provision under the contract ITS bid items.

stp-670-010 (20230629)

### **64. Install ITS Field Cabinet, Item 673.1200.S.**

#### **A Description**

This special provision describes installing a department-furnished type 170, size 334 field cabinet.

#### **B Materials**

The department will furnish the type 170, size 334 field cabinet. Provide all necessary miscellaneous mounting hardware and internal power cables. With the field cabinet, the department will furnish cabinet bolts to anchor the cabinet to the concrete base.

#### **C Construction**

Install the field cabinet on a new or existing concrete base paid separately. Make all power connections to the cabinet, isolating the neutral bus from the cabinet and equipment ground.

Effectively ground all cable grounding shields and any spare or unused conductors in the field cabinet to the equipment grounding terminal strip.

#### **D Measurement**

The department will measure Install ITS Field Cabinet by the unit, installed according to the contract and accepted.

#### **E Payment**

The department will pay for measured quantities at the contract unit price under the following bid item:

ITEM NUMBER	DESCRIPTION	UNIT
673.1200.S	Install ITS Field Cabinet	EACH

Payment is full compensation for installing the state-furnished field cabinet; making all connections; and grounding as necessary.

stp-673-005 (20220107)

**65. Install Pole Mounted Cabinet, Item 673.1225.S.**

**A Description**

This special provision describes installing department furnished aluminum enclosures on poles for intelligent transportation systems equipment.

**B Materials**

Use stainless steel bolts, nuts, and washers unless otherwise specified.

All conductors, terminals, and parts that could be hazardous to maintenance personnel shall be protected with suitable insulating material.

The cabinet will be equipped with service panels. Two panels shall be provided and mounted on the cabinet sidewalls. The left side panel shall be designated as "Input/Communications," and the right side panel shall be designated as the "Service Panel".

The service panel will be equipped with a four-outlet handi-box. Wire the handi-box to the series portion of the filtering surge protector.

Use metallic conduit, fittings, and adapters required from the underground conduit transition point to the cabinet as part of this item. A typical installation requires a 2-inch conduit. Use metallic conduit conforming to standard spec 652.

**C Construction**

Coordinate receiving the cabinet from the department's vendor and protect and store the cabinet between receiving the cabinet and installing as shown on the plans. Note and photograph any damage to the cabinet upon receipt and notify the engineer and the Statewide ITS Engineer of any damage.

Fasten the field cabinet securely onto a pole. Provide bolted stainless steel connections with lock washers, locking nuts, or other engineer-approved means to prevent the connection nuts from backing off. Isolate dissimilar materials from one another using stainless steel fittings. Make all power connections to the cabinet as specified in standard spec 656.

Drill and tap the cabinet, as necessary, to mount the terminal blocks and other attachments to the service panel, to provide an entrance on the back of the cabinet for cable from the pole mounted intelligent transportation systems equipment, and to mount the service panel to the cabinet as shown in the details. Remove all sharp edges or burrs, or both, caused by the cutting or drilling process. Seal all openings to prevent water from entering the cabinet. Mount the surge protector to the service panel.

Install metallic conduit on the exterior of the pole (for entrance to the cabinet from the ground) as the plans show, and according to the applicable requirements of standard spec 652.

**D Measurement**

The department will measure Install Pole Mounted Cabinet as each individual assembly, acceptably completed.

**E Payment**

The department will pay for measured quantities at the contract unit price under the following bid item:

ITEM NUMBER	DESCRIPTION	UNIT
673.1225.S	Install Pole Mounted Cabinet	EACH

Payment is full compensation for storing the pole mounted cabinet, installing the pole mounted cabinet; for making all connections and conduit/wire entrances; and for all testing.

stp-673-010 (20230629)

**66. Cameras.**

*Replace standard spec 677.3(8) with the following:*

- (8) For permanent camera installations, provide camera cables in conduit and poles as the plans show. For temporary traffic signal camera installations, provide camera cables on the temporary traffic signal span wire as the plans show. Provide continuous cable runs without splices between the camera assembly and the camera controller assembly.

**67. Removing 50-FT Camera Pole, Item 677.9051.S.**

**A Description**

This special provision describes removing existing camera poles and all equipment mounted on them.

**B (Vacant)**

**C Construction**

The contractor may request a meeting with the engineer to assess the condition and operability of equipment mounted on the pole before beginning work removing the pole. Any damage or improper operation not noted at the meeting, or before the contractor starting work on the removal, will be assumed to be the fault of the contractor; repair or replace the equipment. Store the equipment for pick up by department representatives.

Disconnect all cables, wiring and equipment that are mounted on or in the poles, and remove the pole from the concrete footing. The department will pick up any antennae, cameras, or other equipment mounted on the pole; contact maintenance staff at (414) 227-2166 at the department's Statewide Traffic Operations Center, when the material is ready to be picked up. Properly dispose of the pole, conduit, cabling, and wiring away from the project site.

**D Measurement**

The department will measure Removing 50-FT Camera Pole by the unit, acceptably removed.

**E Payment**

The department will pay for measured quantities at the contract unit price under the following bid item:

ITEM NUMBER	DESCRIPTION	UNIT
677.9051.S	Removing 50-FT Camera Pole	EACH

Payment is full compensation for removing and disposing of the existing camera pole; disconnecting any necessary wiring; removing the equipment mounted on the poles; disposing of cabling and wiring; disposing of the pole properly off the project site; and transportation.

stp-677-901 (20230629)

**68. Removing CCTV Camera, Item 677.9200.S.**

**A Description**

This special provision describes removing existing CCTV cameras as the plans show from existing camera poles that are not being removed as part of the project. Removal of CCTV cameras on poles also being removed is included with the pay items for removing the poles.

**B (Vacant)**

**C Construction**

The contractor may request a meeting with the engineer to assess the condition and operability of the camera before beginning work on removing the camera. Any damage or improper operation not noted at the meeting, or before the contractor starting work on the removal, will be assumed to be the fault of the contractor; repair or replace the camera. Store the camera until the department picks up the camera.

Disconnect all wiring at the control cabinet and at the top of the camera pole. Remove all fastening hardware and remove the existing camera and pan, tilt, and zoom mechanisms from the top of the pole. Salvage and store the cameras for pick up by the department; contact maintenance staff at (414) 227-2166 at the department's Traffic Management Center (TMC) to coordinate when the materials will be picked up.

**D Measurement**

The department will measure Removing CCTV Camera by the unit, acceptably and completely removed.

**E Payment**

The department will pay for measured quantities at the contract unit price under the following bid item:

ITEM NUMBER	DESCRIPTION	UNIT
677.9200.S	Removing CCTV Camera	EACH

Payment is full compensation for removing an existing CCTV camera; for disconnecting all necessary cables and wiring; and properly storing the materials.

stp-677-902 (20230629)

## **69. Communication Systems.**

*Replace standard spec 678.2.1(1) with the following:*

- (1) The department will furnish fiber optic cable, Ethernet switches, SFP's and cellular modems.

Pick up the department furnished materials at the department's Electrical Shop located at 935 South 60th Street, West Allis. Notify the department's Electrical Field Unit at (414) 266-1170 and make arrangements for picking up the department furnished materials three working days prior to picking up the materials.

## **70. Install Overhead Freeway DMS Full Matrix, Item 678.0100.S.**

### **A Description**

This special provision describes installing a state-furnished, or an existing salvaged, dynamic message sign on a new or existing sign structure.

### **B Materials**

The department will provide the sign, or it will be salvaged, controller, and the control cable. The control cable will be multi-mode fiber optic cable.

Use an AWG #6 copper wire or equivalent bonding straps to bond the sign and cabinet to the structure. Use an AWG #6 solid, bare copper wire to bond the sign structure to ground rods.

1. For the three wires carrying 120/240 VAC power from the cabinet to the sign, use single conductor, stranded copper, 120/240 VAC, XLP insulated, USE rated wire. Size the wire to carry the maximum amperage permitted by the main breakers in the sign.

Provide a 100-amp 120/240-VAC load center in the controller cabinet, along with breakers recommended by the sign manufacturer.

### **C Construction**

Within two weeks of Notice to Proceed, contact the engineer and Statewide ITS Engineer, Dean Beekman at (414) 227-2154. Provide the address and contact information for the contractor-controlled location for delivery and the desired delivery schedule for the DMS. The department will coordinate with the department's contracted DMS vendor for delivery as close as possible to desired delivery date.

The contractor may request that the engineer or other department representative be present at delivery to witness condition of the DMS, controller, and cable. Photograph and note any damage or irregularities in the materials being delivered. The engineer or department representative will coordinate resolution of any damage or irregularities with the DMS vendor. Store the DMS while resolution is being coordinated with the DMS vendor.

Store the DMS, controller, and controller cable in a safe and secure location until installation.

Transport the DMS, controller, and controller cable to the installation site.

Install the load center so that the main breakers control all power to the sign and cabinet. Provide at least three branch circuits, one for the sign, one for the controller and communication equipment, and one for all cabinet accessories, such as fan, light, and heater. Only protect the branch serving the controller and communication equipment with the second stage of the surge protector. Connect the power and control cables according to the manufacturer's recommendations. Run the cables in rigid metallic conduit or flexible metallic conduit, or combination of these, within the sign structure.

Bond the sign directly to one or more ground rods per the manufacturer's instructions and Article 250 of the NEC. Do not bond the sign to the structure. Use exothermic welding at each end of the ground wire. Use an AWG # 6 solid, bare copper wire to bond the sign structure to the ground rod(s). Use a device that measures resistance to ground using the three-point fall-of-potential method to ensure that the resistance from the sign's ground bar to ground does not exceed 4 ohms. Add more ground rods if necessary to achieve this requirement.

## D Measurement

The department will measure Install Overhead Freeway DMS Full Matrix by each sign, acceptably installed and tested.

## E Payment

The department will pay for measured quantities at the contract unit price under the following bid item:

ITEM NUMBER	DESCRIPTION	UNIT
678.0100.S	Install Overhead Freeway DMS Full Matrix	EACH

Payment is full compensation for fabrication and installation of all mounting hardware; receiving delivery of the DMS, controller, and cable; storing the materials until installation; transporting the materials to installation site; installing and testing the sign and controller; providing cables, conduits, and fittings; for testing the sign.

stp-678-010 (20230629)

## 71. Bicycle Rack Asphalt or Concrete-Mounted, Item 999.1950.S.

### A Description

This special provision describes providing bicycle racks on an asphaltic or concrete surface as the plans show.

### B Materials

#### B.1 General

Provide a steel bicycle rack that has been manufactured specifically for use as a bicycle parking rack.

The bicycle rack shall be hot-dipped galvanized, or TGIC (triglycidyl isocyanurate) powder-coated, or plastic-coated. Steel anchors, and miscellaneous hardware shall be hot-dipped galvanized. For powder-coated or plastic-coated racks, provide one of the following colors: midnight blue, black, hunter green, forest green, Lexington blue, patriot blue, RAL 5005, RAL 3003, or RAL 6005.

The bicycle rack base shall have flanges, rails, or tubes that allow the rack to stand upright and can be bolted or screwed in place.

#### B.2 Hanger Style Racks

##### B.2.1 Bicycle Racks Loaded from One Side

The hanger-style bicycle rack shall be designed to park at least three bicycles with arms offset, or centered, in such a manner so that the rack will be loaded from one side by bicyclists. Bicycle spacing shall be 24 inches or more. Pad shall accommodate space on one side of rack according to the manufacturer's specification to allow bikes to be locked to the receiving side of rack and for bicyclists to access that side of rack when racks are full of bikes. This typically requires 8-feet to 9-feet of clearance on the receiving side of rack measured from the center post (the post to which the hangers are attached).

Furnish a bike rack that is on the department's approved product list under "Hanger Style Racks Loaded from One Side."

##### B.2.2 Bicycle Racks Loaded from Two Sides

The hanger-style bicycle rack shall be designed to park at least five bicycles with arms offset, or centered, in such a manner so that the rack will be loaded from two sides by bicyclists. Pad shall accommodate space on both sides of rack according to the manufacturer's specification to allow bikes to be locked to both sides of rack and for bicyclists to access both sides of rack when racks are full of bikes. This typically requires 8-feet to 9-feet on both sides of the rack measured from the center post (the post to which the hangers are attached).

Furnish a bike rack that is on the department's approved product list under "Hanger Style Racks Loaded from Two Sides."



### **B.2.3 Inverted-U Style Racks**

This rack resembles an upside-down letter "U" when installed. Bikes can be locked to both sides of the inverted U. Pad shall accommodate access space along one side of the rack assembly (perpendicular to the inverted U's) according to the manufacturer's specification to allow bikes to be locked to both sides of the inverted U racks and for bicyclists to access the rack assembly when individual U racks are full of bikes. Do not place the rack assembly too close to a wall or other obstruction, negating the ability for bikes to be properly centered on the inverted U racks.

Furnish a U-rack that is on the department's approved product list under "Inverted-U Style Racks." For this listing, three of the inverted U's have been placed on stringers or rails to accommodate up to six bicycles.

#### **C Construction**

Install rack with enough clearance to allow bicyclists to load their bikes from one side or both sides, based on style of rack, and according to the manufacturer's specifications.

Secure the rack to asphalt surface with anchor bolts or screws according to the manufacturer's recommendations.

#### **D Measurement**

The department will measure Bicycle Rack Asphalt or Concrete-Mounted by the unit in place, acceptably furnished and installed.

#### **E Payment**

The department will pay for measured quantities at the contract unit price under the following bid item:

ITEM NUMBER	DESCRIPTION	UNIT
999.1950.S	Bicycle Rack Asphalt or Concrete-Mounted	EACH

Payment is full compensation for furnishing and installing the bicycle rack including all mounting hardware.

stp-999-150 (20080902)

## **72. Backfill Slurry, Item SPV.0035.001.**

### **A Description**

This special provision describes furnishing and placing backfill slurry for, but not limited to, removing and abandoning utility pipes and structures, installation of storm sewer, sanitary sewer, and water pipes and structures, and exposing existing utility items as shown on the plans. Conform to standard spec 209 except as follows.

### **B Materials**

*Replace standard spec 209.2.2 with the following:*

- (1) Use well graded fine and coarse aggregate conforming to the standard combined aggregate gradation specified in table 501-4. Weigh aggregates at a batch plant suitable for batching concrete masonry. Mix and deliver to the project site using a truck mixer. Add enough water meeting the requirements of standard spec 501.2.6 to enable the mixture to flow readily.
- (2) Backfill Slurry is considered a class III concrete mix. Follow the procedure in standard spec 716.2.2 for mix design certification and submittal.

### **C Construction**

*Replace standard spec 209.3 with the following:*

Prior to placement of backfill slurry provide for positive drainage of the area to be backfilled. Discharge from the truck in a manner to prevent segregation. Completely fill excavation in a single operation. Consolidation or compaction effort will not be required.

## D Measurement

Replace standard spec 209.4 with the following:

The department will measure Backfill Slurry in volume by the cubic yard of material placed, acceptably completed. Such volume shall be computed from actual measurements of the dimensions of the area to be backfilled. In irregular or inaccessible areas, the engineer may allow volume to be determined by other appropriate methods.

## E Payment

The department will pay for measured quantities at the contract unit price under the following bid item:

ITEM NUMBER	DESCRIPTION	UNIT
SPV.0035.001	Backfill Slurry	CY

Payment is full compensation conforming to standard spec 209.5.(2) and 209.5.(5).

## 73. Basic Traffic Queue Warning System, Item SPV.0045.001.

### A Description

This special provision describes providing, repositioning, operating, maintaining, monitoring, calibrating, testing, and removing a basic traffic queue warning system (QWS) capable of measuring vehicular speeds at downstream sections of a roadway, and activating the system.

### B Materials

Provide Basic Traffic QWS components and software that is National Transportation Communications for ITS Protocol (NTCIP) compliant.

#### B.1 Portable Traffic Sensors (PTS)

Provide PTS that are nonintrusive and capable of capturing individual vehicle speed (mph) and traffic volume. Integrate each sensor with a modem to communicate with the automated system manager.

#### B.2 Static Traffic Control Signs with Temporary Flashing Beacon Signs (FBS)

Provide static traffic control signs with temporary flashing beacon signs conforming to standard spec 658.2(2) for Traffic Signal Faces. Ensure each FBS is integrated with a PTS, modem, and other equipment (e.g., automated system manager) mounted on it, and acts as a single device for communicating with similarly integrated devices and displaying real-time traffic conditions.

#### B.3 Automated System Manager

Provide an ASM that assesses current traffic data captured by the PTS and activates/deactivates the FBS based on predetermined speed thresholds.

#### B.4 System Communications

Ensure Basic Traffic QWS communications meet the following requirements:

1. Perform required configuration of the Basic Traffic QWS's communication system automatically during system initialization.
2. Communication between the server and any individual FBS or PTS are independent through the full range of deployed locations, and do not rely upon communications with any other FBS or PTS.
3. Incorporate an error detection/correction mechanism into the Basic Traffic QWS communication system to ensure the integrity of all traffic condition data.

#### B.5 System Acceptance

Submit vendor verification to the engineer and Bureau of Traffic Operations ([DOTBTOworkzone@dot.wi.gov](mailto:DOTBTOworkzone@dot.wi.gov)) 14 calendar days before the pre-construction meeting that the system will adequately perform the functions specified in this special provision. Adequate verification includes past successful performance of the system, literature and references from successful use of the system by other agencies, and/or demonstration of the system.

Provide contact information for a designated representative responsible for monitoring the performance of the system and for making modifications to the operational settings as the engineer directs. Provide all testing and calibration equipment.

## **C Construction**

### **C.1 General**

Install and reposition Basic Traffic Queue Warning System per plan or as the engineer directs.

Number the devices in chronological order so they are visible from the shoulder with 6-inch white high reflective sheeting.

Provide technical personnel for all system calibration, operation, maintenance, and timely on-call support services.

Promptly correct the system within 24 hours of becoming aware of a deficiency in the operation or individual part of the system. A minimum of three days before deployment, place the Basic Traffic QWS and demonstrate to the department that the Basic Traffic QWS is operational. Maintain the Basic Traffic QWS for the duration of the project. Ensure the system operates continuously (24 hours, 7 days a week) in the automated mode throughout the duration of the project.

Remove the system upon completion.

### **C.2 Reports**

Provide an electronic copy of a weekly summary report of all data via email to the engineer. Ensure the report includes, at a minimum, the average speed per sensor, traffic volume, time in congestive state per sensor and number of triggers per day.

### **C.3 Meetings**

Attend mandatory in-person pre-construction meetings with the department. Attend additional meetings as deemed necessary by the department. These meetings may be held in person or via teleconference, as scheduled by the department.

### **C.4 Programming**

#### **C.4.1 General**

Program the Basic Traffic QWS to ensure that the following general operations are performed:

1. Provide a password protected login to the ASM, website and all other databases.
2. The FBS activate based on pre-determined speed thresholds from the next downstream sensor.
  - FBS #1 shall activate based on traffic speeds at PTS #2
  - FBS #2 shall activate based on traffic speeds at PTS #1
  - FBS #3 shall activate based on traffic speeds at PTS #2
3. Provide real-time data from the ASM to a website with a full color mapping feature and refresh every 60 seconds. Make data on website available to the department staff at all times for the duration of the work zone activity. Ensure website includes:
  - Vehicle speeds
  - FBS triggers
  - Device locations
  - Traffic volume
4. Archive all traffic data in a Microsoft Excel format with date and time stamps.
5. Configure the website to quantify system failures which includes communication disruption between any devices in the system configuration, FBS malfunctioning, PTS malfunction, loss of power, low battery, etc.
6. Automatically generate and send an email alert any time a user specified queue is detected by the system.
7. Ensure the system autonomously restarts in case of any power failure.

#### **C.4.2 System Operation Strategy**

Arrange for the vendor/manufacturer to coordinate system operation, detection, and trends/thresholds with the engineer.

The sequences below are a minimum requirement, but can be adjusted at the discretion of the engineer, are as follows:

#### **Free Flow:**

If the current PTS speed on a downstream section is at or above 40 mph, the upstream FBS will not flash.

**Slow or Stopped Traffic:**

If the current PTS speed on a downstream section of the roadway is between 39 mph and 0 mph (for example, 35 mph), the FBS must flash.

**C.5 Calibration and Testing**

At the beginning of the project, perform a successful field test and calibration at the Basic Traffic QWS location to verify the system is detecting accurate vehicle speeds, and accurately relaying the information to the ASM and the FBS.

Send email of successful calibration and testing to the engineer.

**D Measurement**

The department will measure Basic Traffic Queue Warning System by the day, acceptably completed, measured as each complete system per roadway.

**E Payment**

The department will pay for measured quantities at the contract unit price under the following bid item:

ITEM NUMBER	DESCRIPTION	UNIT
SPV.0045.001	Basic Traffic Queue Warning System	DAY

Payment is full compensation for providing, repositioning, operating, maintaining, monitoring, calibrating, testing, and removing the complete system consisting of FBS, PTS, ASM, and system communications.

Failure to correct a deficiency to the FBS, PTS, or ASM within 24 hours after notification from the engineer or the department will result in a one-day deduction of the measured quantity for each day in which the deficiency is not corrected.

Failure to correct the website within 24 hours after notification from the engineer will result in a 10% reduction of the day quantity for each day the website is down.

The engineer will have sole discretion to assess the deductions for an improperly working Basic Traffic QWS.

**74. Digital Speed Reduction System (DSRS); Item SPV.0045.002.**

**A Description**

This special provision describes furnishing, installing, repositioning, operating, maintaining, monitoring, testing, and removing a Digital Speed Reduction System (DSRS) per plan or as the engineer directs.

**B Materials**

**B.1 Digital Speed Limit Trailer (DSLTL)**

Furnish items from the department’s approved products list.

**B.2 Portable Changeable Message Sign (PCMS)**

Provide PCMS conforming to standard spec 643. Ensure each PCMS is integrated with a modem and other equipment (e.g., automated system manager) mounted on it.

**B.3 Automated System Manager (ASM)**

Provide an ASM to remotely change the speed limit and PCMS message on the DSRS devices.

**C Construction**

**C.1 General**

Trailer-mount the sign so that the bottom is a minimum 7 feet above the roadway.

Install and operate DSRS 7 days in advance of the start of the temporary speed declaration start date. Perform a successful field test for each sign.

Provide in-person training to the department on the use and operation of the field hardware and the website for the DSRS.

Ensure the DSRS operates continuously when deployed on the project.

Provide a local specialist, to respond to emergency situations within 2 hours of being notified and who is equipped with sufficient resources to correct deficiencies in the DSRS.

There shall not be any conflicting speed limits displayed throughout the project limits.

The contractor will be responsible for coordinating with the Engineer when the work zone speed limits are to be changed.

Place PCMS at the following location or per plan:

- 2,200 feet upstream of start of lane closure taper on the right side of the roadway or as directed by the engineer.

Place Digital Speed Limit Trailer at the following locations or per plan:

- 1,500 feet upstream of start of lane closure taper on both sides of the roadway
- 1,500 feet beyond the end of the acceleration lane of each entrance ramp
- 700 feet upstream of worker activity
- Minimum of every 1 mile, in active work area or where workers are present

Placement of the Digital Speed Limit Trailers shall be on the right side of the roadway unless located in advance warning area, infeasible or as directed by the Engineer.

Placement of Digital Speed Limit Trailer and PCMS shall not interfere with the function of existing signs or roadside devices.

R2-1 sign shall be 48" x 60" and follow standard spec 643 for sign requirements.

## **C.2 Programming**

Program the DSRS to ensure the following operations are performed:

- 1) Provide a password protected login to the ASM, website and all other databases.
- 2) Provide real-time data from the ASM to a website and refresh every 60 seconds. The website should have a full-color mapping feature. Data on the website should be available to the department staff at all times for the duration of the work zone activity and should include:
  - Dates and times of speed limit changes
  - Messages
  - Device locations
- 3) Archive all data in a Microsoft Excel format with date and time stamps.
- 4) Configure the website to quantify system failures which includes PCMS and/or digital speed limit trailer malfunction, loss of power, low battery, etc.
- 5) Ensure the devices autonomously restart in case of any power failure.
- 6) Provide the department access to manually override the DSRS for a user-specified duration. Document all override messages.
- 7) The digital display portion automatically adjusts the brightness under varying light conditions to maintain legibility.
- 8) Speed limit values shown on the digital display legend continuously displays without animation. Brief blanking may be experienced, up to 10 seconds, only during digital display legend user input utilizing the hard-wired hand control.
- 9) The digital display changes between the original posted speed limit and the approved temporary speed limit on the digital speed limit trailer when directed by the engineer.
- 10) The PCMS changes between the flashing four corner arrow board mode and the "Posted Speed Reduction" message per plan when directed by the engineer.
- 11) Digital speed limit trailers and PCMS shall change simultaneously, at the same time to only display one speed limit.
- 12) The beacon on the DSRS shall flash when the speed limit has been reduced per the temporary speed declaration.

### C.3 Reports

Provide an electronic copy of a weekly summary report and end of project summary report via email to the Engineer and Bureau of Traffic Operations ([DOTBTOworkzone@dot.wi.gov](mailto:DOTBTOworkzone@dot.wi.gov)). Include timestamped information on the date, time, messages, and speed limit for when the DSRS was changed.

### D Measurement

The department will measure Digital Speed Reduction System (DSRS) by the day, acceptably completed.

### E Payment

The department will pay for measured quantities at the contract unit price under the following bid item:

ITEM NUMBER	DESCRIPTION	UNIT
SPV.0045.002	Digital Speed Reduction System (DSRS)	DAY

Payment is full compensation for furnishing, installing, repositioning, operating, maintaining, monitoring, testing, and removing for a DSRS.

Failure to correct a deficiency to the DSRS within 24 hours after notification from the engineer or the department will result in a one-day deduction of the measured quantity for each day in which the deficiency is not corrected.

The engineer will have the sole discretion to assess the deductions for an improperly working DSRS.

## 75. Tension Anchor Rods, Item SPV.0060.001.

### A Description

This special provision describes re-tensioning loose anchor rod nuts as shown on the plans, and as hereinafter provided.

### B Materials

Furnish materials that are according to the pertinent provisions of standard spec 531 and as shown in the plans.

### C Construction

Use construction methods that are according to the pertinent provisions of standard spec 532 and as shown in the plans. This work will consist of re-tensioning all loose anchor rod nuts as specified in the plans. This includes removing lock washers, adding flat and beveled washers when anchor rods are out of plumb by more than 1:40 and as noted. The contractor shall follow the re-tensioning procedure outlined herein:

1. The contractor shall verify the grade of the anchor rod. If an anchor rod grade cannot be verified, the department shall be contacted for direction. Note that A36 rods have different tensioning requirements.
2. The contractor shall verify the size and number of nuts required to be replaced. Note that if one or more are found to be loose, all are required to be replaced.
3. Remove all jam nuts<sup>1</sup>.
4. The contractor shall furnish flat washers and heavy hex nuts conforming to standard spec 531.2.2. Existing jam nuts<sup>1</sup> may be reused. Galvanized beveled washers may be required and will conform to the requirements in 531.
5. Remove rodent screen<sup>1</sup>.
6. Remove and dispose of the grout pad<sup>1</sup> according to standard spec 509.3.4.
7. Tighten all nuts that are loose to snug tight (leveling and top nut). Reference the department's Form DT2321 for snug tight torque values.
8. Contact the department for direction if the levelling or top nut is not in full contact with the base plate after snugging or cannot be turned.
9. Once all nuts are snug, remove one and only one top nut at a time and follow the remaining procedure. Top nuts, flat washers, and locking washers (if applicable) shall be discarded, the leveling nuts shall remain, and jam nuts<sup>1</sup> may be reused.

10. Clean anchor rod with a wire brush to remove rust and dirt from anchor rod threads and base plate.
11. Apply one light coat of fast drying zinc rich primer or spray-on cold galvanized conforming to 532.3.2(2) (if rust is present) to the full length of the anchor bolt and at damaged base plates. Repair of galvanized coating incidental to the re-tensioning process. Galvanizing must be allowed to dry before continuing.
12. Apply wax-based lubricant to the anchor rod.
13. Conform to 532.3.6 and as follows to re-tension anchors. Install top nut to snug tight. Reference the department's form DT2321 for snug tight torque values.
14. Repeat steps 9 through 12 in this specification until all washers and nuts have been replaced.
15. Tension the anchor rod nuts. Follow the department's Form DT2321 procedure steps 5 through 7 and record the tensioning process.
16. Clean, lubricate and re-install jam nut<sup>1</sup> per step 8 of Form DT2321.
17. Reinstall the rodent screen<sup>1</sup> according to the "Rodent Screen" article.
18. Complete Form DT2321 for each structure and submit to the Engineer for transmittal to Bureau of Structures and inclusion in HSIS.

Note<sup>1</sup> – Only for structures that have jam nuts, grout, or rodent screens.

All work for this item, including site clean-up, shall be completed in one shift.

If it is a cantilever structure with a connection which has 6 or less anchor rods, the truss or mast arm shall be supported by a crane during re-tensioning. In lieu of a supporting crane, the contractor may instead submit a structural analysis of the structure addressing proposed constructability which ensure the stability and safety of workers and the traveling public. Analysis computation and support document shall be signed, sealed, and dated by a professional engineer licensed in Wisconsin, and shall be submitted to the engineer and BOS for permanent record.

#### **D Measurement**

The department will measure Tension Anchor Rods as each individual anchor rod, acceptably completed.

#### **E Payment**

The department will pay for measured quantities at the contract unit price under the following bid item:

ITEM NUMBER	DESCRIPTION	UNIT
SPV.0060.001	Tension Anchor Rods	EACH

Payment is full compensation for tensioning loose anchor rod nuts; for removing and properly disposing of existing materials being replaced; for furnishing all materials and miscellaneous items to complete the repair; for fabricating, handling, transporting, and erecting.

### **76. Remove Grout Pad, Item SPV.0060.002.**

#### **A Description**

This special provision describes removing grout pads under base plates as shown on the plans, and as hereinafter provided.

#### **B Materials**

Furnish cold-applied galvanizing according to "Tension Anchor Rod" Article.

Furnish rodent screen and wire to secure the rodent screen according to the "Replace Rodent Screen" Article.

#### **C Construction**

Remove and dispose of the grout pad use air chippers or breakers that weigh no more than 35 pounds and are equipped with flat, chisel-type points with a cutting edge not less than 3/4 inch or greater than 3 inches wide. After reaching the edge of the anchor rods, do not use hammers heavier than 15 pounds within one inch of the steel. Dispose of old concrete and asphaltic patching removed away from the bridge site. Implement necessary procedures to minimize debris dropping into the stream, streambed,

roadway, or right-of-way below. If the foundation spalls during removal of grout pad, repair according to standard spec 509.3.7. If excessive areas begin to spall, contact BOS for guidance.

Measure distance from top of concrete to bottom of leveling nut. If the distance is greater than the diameter of the anchor rod, contact the department for further instruction.

Thoroughly clean the existing anchor rods and leveling nuts below the base plate, roughen the surface on the anchor rods and apply cold-galvanizing to the anchor rods and leveling nuts.

Install a rodent screen according to the Replace Rodent Screen Article if electrical devices are installed on the structure.

**D Measurement**

The department will measure Remove Grout Pad by each unit, acceptably completed.

**E Payment**

The department will pay for measured quantities at the contract unit price under the following bid item:

ITEM NUMBER	DESCRIPTION	UNIT
SPV.0060.002	Remove Grout Pad	EACH

Payment is full compensation for removing and disposing of the grout pad; cleaning and applying cold-galvanizing, and for providing and installing a rodent screen.

**77. Remove Debris and Regrade, Item SPV.0060.003.**

**A Description**

This special provision describes removing debris and grading around the foundation as shown on the plans, and as hereinafter provided.

**B (Vacant)**

**C Construction**

Remove debris and dispose of it according to standard spec 202. Grade the area around the foundation to drain according to standard spec 213.

**D Measurement**

The department will measure Remove Debris and Regrade as each foundation location, acceptably completed.

**E Payment**

The department will pay for measured quantities at the contract unit price under the following bid item:

ITEM NUMBER	DESCRIPTION	UNIT
SPV.0060.003	Remove Debris and Regrade	EACH

Payment is full compensation for removing and disposing of the debris; grading to the foundation; and restoration.

**78. Adjust Sign, Item SPV.0060.004.**

**A Description**

This special provision describes adjusting vertical clearance, rotation or securing signs as shown on the plans, and as hereinafter provided.

**B Materials**

Furnish materials that are according to specifications and as required by WisDOT Sign Plates A4-7A and A4-7B.



**C Construction**

Signs marked in the plan were incorrectly installed, are loose, rotated or installed below the minimum vertical clearance. Reset the sign connection so that it is tight, in the correct orientation and at the proper elevation. Use construction methods that are according to standard spec 637 and as shown in the plans.

New connection hardware is required, conform to installation requirements of standard spec 637 and sign plate details noted in the materials section.

**D Measurement**

The department will measure Adjust Sign by each unit, acceptably completed.

**E Payment**

The department will pay for the measured quantities at the contract unit price under the following bid item:

ITEM NUMBER	DESCRIPTION	UNIT
SPV.0060.004	Adjust Sign	EACH

Payment is full compensation for field verifying existing conditions; and for furnishing and installing all connection hardware and attaching the sign.

**79. U-Bolt, Item SPV.0060.005.**

**A Description**

This special provision describes furnishing and replacing damaged, loose, or incorrectly placed U-bolts as shown on the plans, and as hereinafter provided.

**B Materials**

Stainless steel U-bolts and lock washers shall conform to ASTM 304. Stainless steel hex nuts shall conform to ASTM A276.

**C Construction**

Field verify the size. Use construction methods that are according to the pertinent provisions of standard spec 532, WisDOT Sign Plates A4-7A and A4-7B, and as shown in the plans.

**D Measurement**

The department will measure U-Bolt as each individual U-bolt, acceptably completed.

**E Payment**

The department will pay for measured quantities at the contract unit price under the following bid item:

ITEM NUMBER	DESCRIPTION	UNIT
SPV.0060.005	U-Bolt	EACH

Payment is full compensation for furnishing and replacing U-bolts, nuts, and lock washers; for removing and properly disposing of existing materials; for furnishing all materials and miscellaneous items to complete the repair; for fabricating, drilling, handling, transporting, and erecting.

**80. Remove Catwalk, Item SPV.0060.006.**

**A Description**

This special provision describes wholly or partially removing the catwalk as shown on the plans, and as hereinafter provided.

**B (Vacant)**

**C Construction**

Use construction methods that are according to standard spec 204, state standard details, and as shown in the plans.

## D Measurement

The department will measure Remove Catwalk as each individual item, acceptably completed.

## E Payment

The department will pay for measured quantities at the contract unit price under the following bid item:

ITEM NUMBER	DESCRIPTION	UNIT
SPV.0060.006	Remove Catwalk	EACH

Payment is full compensation for field verifying existing conditions; and for removing and properly disposing of the existing catwalk materials and connection hardware.

## 81. Lower Structure, Item SPV.0060.007.

### A Description

This special provision describes lowering the structure to achieve the correct standoff as shown on the plans, and as hereinafter provided.

### B Materials

Furnish materials conforming to standard spec 531 and 532.

### C Construction

Use construction methods that are according to the pertinent provisions of standard spec 532 and as shown in the plans. The contractor will be responsible for the following details:

- Removing the signs and signals and associated supports from the chord.
- Disconnect signal wiring and remove the chord from the posts.
- Remove posts from anchors. Verify that anchors are not damaged. Discard existing nuts and washers.
- Set new leveling nuts such that the base plates are less than 2½" from top of concrete and re-install posts and ensure they are plumb. Tension anchor rods according to DT2321. Use beveled washers if rods are more than 1:40 out of plumb. If rods are more than 1:20 out of plumb, contact the Bureau of Structures.
- Replacing the original post connection bolts with new high strength splice bolts using the following steps:
  1. The contractor shall field verify the size and number of bolts, nuts, flat washers, and Direct Tension Indicator (DTI) washers to be replaced. Note that since the DTI's are to be utilized, the number of washers may change, and the lengths of the bolts may need to be increased.
  2. Lock washers shall not be used in new splice connections.
  3. Chord re-installation shall conform to standard spec 532.3.4 and 532.3.6.
- Reinstalling the chord onto the posts to the correct height and position.
- Reinstalling the sign panels and signal to the correct orientation above the designated lanes and reconnect wiring.
- Replace all I-beams, U-bolts, nuts, washers, sign panel connectors, and sign or signal support brackets which have indications of corrosion or damage or have been placed incorrectly on the chords. New connection hardware shall be according to WisDOT Sign Plates A4-7A and A-4-7B for signs and standard spec 658 and the APL for signal connections.

During the removal of the truss from the posts, the truss shall be adequately supported by a mobile crane. The truss shall be removed and replaced within the same working shift/night.

Any damage, including signs, I-beams, U-bolts, nuts, washers, sign panel connectors, and sign or signal support brackets, is the responsibility of the contractor and shall be repaired and/or replaced at their cost.

## D Measurement

The department will measure Lower Structure as each structure, acceptably completed.

## E Payment

The department will pay for the measured quantities at the contract unit price under the following bid item:

ITEM NUMBER	DESCRIPTION	UNIT
SPV.0060.007	Lower Structure	EACH

Payment is full compensation for removing, lowering and reinstalling the structure in its correct orientation; for removing and properly disposing of existing materials being replaced; for all cranes/lifts required to lift and support the structure during removal and reinstallation, for furnishing all materials, including high-strength structural bolts, shims, U-bolts, nuts, washers, sign panel connectors, and sign support brackets to complete the repair; handling, and erecting.

## 82. Re-install Truss/Arm, Item SPV.0060.008.

### A Description

This special provision describes removing and reinstalling the truss to the correct orientation as shown on the plans, and as hereinafter provided.

### B Materials

Furnish materials that are according to standard spec 532 and as shown in the plans. High strength bolts used in the connection between the truss and post shall be replaced with bolts meeting the requirements of standard spec 532 and according to "Tension Structural Connection Bolt" and "Snug Tight Bolt" articles. All sign connection hardware is to be replaced. I-beams may be reused if they do not contain slotted holes.

### C Construction

Use construction methods that are according to the pertinent provisions of standard spec 532 and as shown in the plans. In its current orientation, the sign support truss was erected upside-down. The contractor will be responsible for the following details:

- Removing the signs and associated supports from the truss.
- Removing the truss from the post.
- Vertically rotating the truss (or part of truss) 180 degrees, re-tensioning splice bolts if needed.
- Replacing the original post connection bolts with new high strength splice bolts using the following steps:
  1. The contractor shall field verify the size and number of bolts, nuts, flat washers, and Direct Tension Indicator (DTI) washers to be replaced. Note that since the DTI's are to be utilized, the number of washers may change, and the lengths of the bolts may need to be increased.
  2. Lock washers shall not be used in new splice connections.
  3. Truss re-installation shall conform to standard spec 532.3.4 and 532.3.6.
- Reinstalling the truss onto the post to the correct height and position.
- Reinstalling the sign panels to the correct orientation above the designated lanes.
- Replace all U-bolts, nuts, washers, sign panel connectors, and sign support brackets which have indications of corrosion or damage.

During the removal of the truss from the posts, the truss shall be adequately supported by a mobile crane. The truss shall be removed and replaced within the same working shift/night.

Any damage, including signs, U-bolts, nuts, washers, sign panel connectors, and sign support brackets, is the responsibility of the contractor and shall be repaired and/or replaced at their cost.

### D Measurement

The department will measure Reinstall Truss/Arm as each individual structure, acceptably reinstalled in the correct orientation.

### E Payment

The department will pay for measured quantities at the contract unit price under the following bid item:

ITEM NUMBER	DESCRIPTION	UNIT
SPV.0060.008	Re-install Truss/Arm	EACH

Payment is full compensation for reinstalling the truss in its correct orientation; for removing and properly disposing of existing materials being replaced; for all cranes/lifts required to lift and support the structure during removal and reinstallation, for furnishing all materials, including high-strength structural bolts, shims, U-bolts, nuts, washers, sign panel connectors, and sign support brackets to complete the repair; handling, and erecting.

**83. Vertical Sign Support, Item SPV.0060.009.**

**A Description**

This special provision describes replacing the damaged or missing type II support brackets as shown on the plans, and as hereinafter provided.

**B Materials**

Furnish 2 Aluminum I Beams (15 X 3.7) and 4 U-bolts for each Type II Sign for overhead signs support that are according to standard spec 637, WisDOT Sign Plates A4-7A and A4-7B and as shown in the plans.

**C Construction**

Take down the existing sign panel and remove the existing support bracket and properly dispose of the bracket assembly. Use construction methods that are according to standard spec 637 and 641 and as shown in the plans. Provide torque requirement and other installation instructions to the department. All bolts, nuts, washers, or miscellaneous items required to replace the damaged or deteriorated sign bracket with 2 I-Beams per sign will be considered incidental to this item. If an existing sign is to be re-installed, the installation of the sign is incidental to Vertical Sign Support.

**D Measurement**

The department will measure Vertical Sign Support as each individual I-beam assembly, acceptably installed.

**E Payment**

The department will pay for measured quantities at the contract unit price under the following bid item:

ITEM NUMBER	DESCRIPTION	UNIT
SPV.0060.009	Vertical Sign Support	EACH

Payment is full compensation for replacing sign type II sign support bracket with new aluminum I Beams and U-bolts; for removing and properly disposing of existing materials being replaced; for furnishing all materials and miscellaneous items to complete the repair; for handling, transporting, and erecting.

**84. Strapping C-67-1570, Item SPV.0060.010.**

**A Description**

This special provision describes securing a wing wall to a culvert or abutment body with a structural channel.

**B Materials**

Use galvanized structural channel conforming to the size and material shown on the plans and conforming to standard spec 506.

**C Construction**

Attach the structural channel with the number, size and spacing of anchors shown on the plans.

**D Measurement**

The department will measure Strapping C-67-1570 as each wing for the repair work, acceptably completed.

**E Payment**

The department will pay for measured quantities at the contract unit price under the following bid item:

ITEM NUMBER	DESCRIPTION	UNIT
SPV.0060.010	Strapping C-67-1570	EACH

Payment is full compensation for furnishing and installing the channel.

**85. Catwalk Repair, Item SPV.0060.011.**

**A Description**

This special provision describes replacing and adjusting placement of catwalk safety chains, replacing handrail sections, grating, and toe boards, and realigning and repairing handrail hinge mechanisms as shown on the plans, and as hereinafter provided.

**B Materials**

Furnish materials that are according to standard spec 532 and as shown in the plans.

**C Construction**

Use construction methods that are according to standard spec 532, state standard details, and as shown in the plans.

Field verify the length of safety chain required and the diameter of existing eyebolts.

Provide new eye bolts (minimum of 1/8" diameter), nuts and washers for the safety chain. If the new eyebolts cannot be installed in the existing connection holes, drill the existing connection holes large enough to accept the new eyebolts. Remove and properly dispose of the existing safety chain being replaced.

**D Measurement**

The department will measure Catwalk Repair as each individual item, acceptably completed.

**E Payment**

The department will pay for measured quantities at the contract unit price under the following bid item:

ITEM NUMBER	DESCRIPTION	UNIT
SPV.0060.011	Catwalk Repair	EACH

Payment is full compensation for field verifying existing conditions; for removing and properly disposing of the existing materials and connection hardware; for furnishing and installing the new equipment and connection hardware, including drilling connection holes.

**86. Replace Conduit Connector, Item SPV.0060.012.**

**A Description**

This special provision describes replacing missing conduit plugs as shown on the plans, and as hereinafter provided.

**B Materials**

Furnish materials that are according to standard spec 652 and as shown in the plans.

**C Construction**

Use construction methods that are according to standard spec 652 and as shown in the plans.

Field verify the size of the conduit connector required.

**D Measurement**

The department will measure Replace Conduit Connector as each individual conduit plug, acceptably completed.

**E Payment**

The department will pay for measured quantities at the contract unit price under the following bid item:

ITEM NUMBER	DESCRIPTION	UNIT
SPV.0060.012	Replace Conduit Connector	EACH

Payment is full compensation for field verifying existing conditions; for furnishing and installing the new conduit connector.

**87. Survey Project, Item SPV.0060.050.**

**A Description**

This special provision describes modifying standard spec 105.6 and 650 to define the requirements for construction staking for this contract. Conform to standard spec 105.6 and 650 and as follows.

The department will not perform any construction staking for this contract. Obtain engineer's approval before performing all survey required to lay out and construct the work under this contract.

*Replace standard spec 650.1 with the following:*

This section describes the contractor-performed construction staking required under individual contract bid items to establish the horizontal and vertical position for all aspects of construction including:

- cable barrier
- beam guard
- storm sewer
- subgrade
- base
- pipe culverts
- drainage structures
- pavement
- curb & gutter
- curb ramps
- fencing
- traffic signals
- ITS
- FTMS
- pavement markings (temporary and permanent)
- barriers (temporary and permanent)
- supplemental control
- structure layout
- bridges
- retaining wall layout
- overhead signs
- slope stakes
- utilities
- conduit
- electrical installations
- landscaping elements
- traffic control items

**B (Vacant)**

**C Construction**

*Add the following to standard spec 650.3.1 (5):*

Confirm with engineer before using global positioning methods to establish the following:

1. Storm Sewer layout horizontal or vertical locations, including structure centers, offsets, access openings, rim and invert elevations.

*Replace standard spec 650.3.1(6) with the following:*

- (6) Maintain neat, orderly, and complete survey notes, drawings, and computations used in establishing the lines and grades. This includes:
- Raw data files
  - Digital stakeout reports
  - Control check reports
  - Supplemental control files (along with method used to establish coordinates and elevation)
  - Calibration report

Make the survey notes and computations available to the engineer within 24 hours as the work progresses unless a longer period is approved by the engineer.

*Replace standard spec 650.3.3.1 with the following:*

Under the Survey Project bid item, global positioning system (GPS) machine guidance for conventional subgrade staking on all or part of the work may be substituted. The engineer may require reverting to conventional subgrade staking methods for all or part of the work at any point during construction if the GPS machine guidance is producing unacceptable results.

*Replace standard spec 650.3.3.4.1 with the following:*

The department will provide the contractor staking packet as described in the Construction and Materials Manual (CMM) 7.10. At any time after the contract is awarded, the available survey and design information may be requested. The department will provide that information within 5 business days of receiving the contractor's request. The department incurs no additional liability beyond that specified in standard spec 105.6 or standard spec 650 by having provided this additional information.

*Add the following to standard spec 650.3.3.6.2 as paragraph four:*

Record all subgrade elevation checks and submit a hard copy to the engineer within 24 hours or as requested by the engineer.

## **D Measurement**

*Replace standard spec 650.4 with the following:*

- (1) The department will measure Survey Project by each project, acceptably completed.

## **E Payment**

*Replace standard spec 650.5 with the following:*

The department will pay for measured quantities at the contract unit price under the following bid item:

ITEM NUMBER	DESCRIPTION	UNIT
SPV.0060.050	Survey Project	EACH

Payment is full compensation for performing all survey work required to lay out and construct all work under this contract and for adjusting stakes to ensure compatibility with existing field conditions. The department will not make final payment for this item until the contractor submits all survey notes and computations used to establish the required lines and grades to the engineer within 24 hours of completing this work. Re-staking due to construction disturbance and knock-outs will be performed at no additional cost to the department.

sef-650-005 (20181219)

**88. Baseline CPM Progress Schedule, Item SPV.0060.051;  
Monthly CPM Progress Schedule Updates, Item SPV.0060.052.**

*Replace standard spec 108.4 with the following:*

**108.4 Critical Path Method Progress Schedule**

**108.4.1 Definitions**

(1) The department defines terms used in 108.4 as follows:

<b>Activity</b>	An administrative or construction task performed during the course of the project with a defined duration, and scheduled (or actual) start and finish dates.
<b>Critical Path</b>	The longest continuous chain of activities through the CPM schedule that establishes the minimum overall project duration.
<b>Construction Activity</b>	Construction activities are discrete work activities performed by the contractor, subcontractors, utilities, or third parties within the project limits.
<b>CPM Progress Schedule</b>	A Critical Path Method (CPM) Progress Schedule is a network of logically related activities. The CPM schedule calculates when activities can be performed and establishes the critical or longest continuous path or paths of activities through the project.
<b>Float</b>	Float, as used in this special provision, is the total float of an activity; i.e., it is the amount of time between the date when an activity can start (the early start), and the date when an activity must start (the late start). In cases where the total float of an activity has a different value when calculated based on the finish dates, the lower (more critical) value will govern.
<b>Forecast Completion Date</b>	The completion date predicted by the latest accepted CPM Update, which may be earlier or later than the contract completion date, depending on progress.
<b>Fragnet</b>	A group of logically-related activities, typically inserted into an existing CPM schedule to model a portion of the project, such as the work associated with a change order.
<b>Initial Work Plan</b>	The initial work plan is a time-scaled CPM schedule showing detailed activities for the first 90 calendar days of work and summary level activities for the remainder of the project.
<b>Intermediate Milestone Date</b>	A contractually required date for the completion of a portion of the work, so that a subsequent portion of the work or stage of traffic phasing may proceed.
<b>Master Program Schedule</b>	The department's schedule for the overall IH 41 Project, including intermediate milestone dates and contract completion dates, and containing codes for use as a template for the development of the contractor's schedule.
<b>Master Project Schedule</b>	The department's schedule for the contract work, developed during design, and provided to the contractor for informational purposes only.
<b>Work Breakdown Structure (WBS)</b>	A framework for organizing the activities that make up a project by breaking the project into successively greater detail by level. A WBS organizes the project work. It does not address the sequencing and scheduling of project activities.

**108.4.2 Department's Master Schedules**

**108.4.2.1 Master Project Schedule**

(1) If requested by a bidder or by the contractor, the department will supply its Master Project Schedule for the contract work, developed during design. The Master Project Schedule is not a direction on how to perform the work. The Master Project Schedule reflects one possible approach to the work, consistent with the phasing requirements.

**108.4.2.2 Master Program Schedule**

(1) Within five business days after award, the department will provide its current Master Program Schedule, containing intermediate milestone constraints, standard activity codes, and a standard WBS for the contractor to use to develop its schedule.



### **108.4.2.3 Use of Department's Master Schedules**

- (1) The department's Master Schedules provide information to assist the contractor in preparing its schedule. The Master Schedules are not contract documents. The logic contained in the Master Schedules is not intended to alter or supplement contract requirements for the phasing of the work, but to reflect those requirements.

### **108.4.3 Contractor's Scheduling Responsibilities**

- (1) Prepare and submit a CPM progress schedule that accurately reflects the plan for the performance of the work, based on the physical requirements of the Work, and Traffic Phasing requirements. The CPM schedule is the contractor's committed plan to complete all work within the completion deadlines. Full responsibility is assumed for the prosecution of the work as shown. The CPM schedule is not part of the contract. Schedule the Work in the manner required to achieve the completion date and intermediate milestone dates specified in the Prosecution and Progress Special Provision.
- (2) Use the department-provided Master Program Schedule as a template to develop the Initial Work Plan and the Baseline CPM Progress Schedule. Use the Master Program Schedule's ID coding structure to categorize activities by Contract, Stage, Location, and Responsibility to ensure compatibility with the Master Program Schedule and with schedules prepared by other contractors. Add additional activity codes as necessary, but do not delete the coding structure provided.
- (3) To ensure compatibility with the Master Program Schedule, use the latest version of Primavera P6 Project Management, by Oracle Corporation, Redwood Shores, CA, to prepare the Initial Work Plan, Baseline CPM Progress Schedule, and Monthly CPM Updates.
- (4) Designate a Project Scheduler who will be responsible for scheduling the Work and submit a professional resume describing a minimum of three years of scheduling experience on urban, interstate-highway reconstruction work of similar size and complexity, including recent experience with P6. Obtain approval of the submitted resume before scheduling the work.

### **108.4.4 Submittals**

#### **108.4.4.1 Initial Work Plan**

- (1) Within ten business days after the Initial Work Plan Workshop, as scheduled in standard spec 103.10, submit an Initial Work Plan as follows:
  1. Develop the Initial Work Plan using the Master Program Schedule as a template. Identify the contemplated start and completion dates for each activity.
  2. Provide a detailed plan of activities to be performed within the first 90 calendar days of the contract. Provide construction activities with durations not greater than 28 calendar days (20 business days), unless the engineer accepts requested exceptions.
  3. Provide activities as necessary to depict administrative work, including submittals, reviews, and procurements that will occur within the first 90 calendar days of the contract. Show additional activities that require department review or approval. Activities other than construction activities may have durations greater than 28 calendar days (20 business days). Allow 21 calendar days (15 business days) for department review of submittals.
  4. Provide summary activities for the balance of the project. Summary activities may have durations greater than 28 calendar days (20 business days).
  5. Submit three copies of the Initial Work Plan in a compressed (XER) format on three separate CDs.
  6. The engineer will accept the contractor's Initial Work Plan or provide comments within five business days after receipt of the Initial Work Plan. Address comments and resubmit the Initial Work Plan as necessary. Do not begin work until the engineer accepts the Initial Work Plan. The department will use the initial work plan to monitor the progress of the work until the Baseline CPM Progress Schedule is accepted.
  7. Submit an updated version of the Initial Work Plan monthly until the engineer accepts the Baseline CPM Progress Schedule. With each update, include actual start dates, completion percentages, and remaining durations for activities started but not completed. Include actual finish dates for completed activities.
  8. Ensure the Initial Work Plan shows completing the work within the interim completion dates and specified completion date.
  9. Include activities that describe essential features of the work and activities that might potentially delay contract completion. Identify activities that are controlling items of work.

#### 108.4.4.2 Baseline CPM Progress Schedule

- (1) Within 15 business days after the CPM Scheduling Workshop, as scheduled in standard spec 103.10 of the Contract Award and Execution special provision, submit a Baseline CPM Progress Schedule and written narrative. The department will use the schedule to monitor the progress of the work.
  1. Develop the Baseline CPM using the Master Program Schedule as a template. The Baseline CPM is the contractor's committed plan to complete the Work within the time frames required to achieve the contract completion date and intermediate milestone dates.
    - 1.1. Provide a detailed plan of activities to be performed during the entire contract duration, including all administrative and construction activities required to complete the work as described in the contract documents. Provide construction activities with durations not greater than 28 calendar days (20 business days), unless the engineer accepts requested exceptions.
    - 1.2. Provide activities as necessary to depict administrative work, including submittals, reviews, procurements, inspections, and all else necessary to complete the work as described in the contract documents. Activities other than construction activities may have durations greater than 28 calendar days (20 business days). Allow 21 calendar days (15 business days) for department review of submittals.
    - 1.3. Submit a temporary drainage plan showing the interface between various stages of a project as well as the interface with adjacent projects.
    - 1.4. Include activities that describe essential features of the work and activities that might potentially delay contract completion. Identify activities that are controlling items of work.
    - 1.5. Show completing the work within interim completion dates and the specified completion date.
    - 1.6. Provide summary activities for the balance of the project. Summary activities may have durations greater than 28 calendar days (20 business days).
    - 1.7. Provide activities as necessary to depict third party work related to the contract.
    - 1.8. Make allowance for specified work restrictions, non-working days, time constraints, calendars, and weather; and reflect involvement and reviews by the department, and coordination with adjacent contractors, utility owners, and other third parties.
    - 1.9. With the exception of the Project Start Milestone and Project Completion Milestone, all activities must have predecessors and successors. The start of an activity shall have a Start-to-Start or Finish-to-Start relationship with preceding activities. The completion of an activity shall have a Finish-to-Start or Finish-to-Finish relationship with succeeding activities. Do not use Start-to-Finish relationships. Do not use Finish-to-Start relationships with a lag unless the engineer accepts requested exceptions.
    - 1.10. Schedule all intermediate milestones in the proper sequence and input as either a "Start-no-Earlier-Than" or "Finish-no-Later-Than" date. Provide predecessors and successors for each intermediate milestone as necessary to model each Stage of the Work. Unless the engineer accepts a requested exception, the schedule should encompass all the time in the contract period between the starting date and the specified completion date.
    - 1.11. Using the bid quantities and unit prices, develop an anticipated cash-flow curve for the project, based on the Baseline CPM.
  2. Provide three hard copies of a hand-drawn or electronically drafted logic diagram depicting the CPM network. Organize the logic diagram by grouping related activities, based on the activity codes in the CPM.
  3. Provide a written narrative with the baseline CPM explaining the planned sequence of work, as-planned critical path, critical activities for achieving intermediate milestone dates, traffic phasing, and planned labor and equipment resources. Use the narrative to further explain:
    - 3.1. The basis for activity durations in terms of production rates for each major type of work (number of shifts per day and number of hours per shift), and equipment usage and limitations.
    - 3.2. Use of constraints.
    - 3.3. Use of calendars.
    - 3.4. Estimated number of adverse weather days on a monthly-basis.
    - 3.5. Scheduling of permit and environmental constraints, and coordination of the schedule with other contractors, utilities, and public entities.
- (1) Submit three copies of the Baseline CPM in a compressed (XER) format on three separate CDs.
- (2) Within ten business days of receiving the Baseline CPM, the engineer will provide comments and schedule a meeting for the contractor to present its Baseline CPM and answer questions raised in the engineer's review.
- (3) At the meeting scheduled by the engineer, provide a presentation of the Baseline CPM. In the presentation, include a discussion of the staging and sequencing of the work, understanding of traffic phasing, and application of labor and equipment resources to the Work. Address comments raised in the engineer's review.

- (4) Within five business days after the meeting, the engineer will accept the contractor's Baseline CPM schedule or provide comments. Address the engineer's comments and resubmit a revised Baseline CPM within ten business days after the engineer's request. If the engineer requests justification for activity durations, provide information that may include estimated labor, equipment, unit quantities, and production rates used to determine the activity duration.
- (5) The department will only make progress payments for the value of materials, as specified in 109.6.3.2, until the contractor has submitted the Baseline CPM Schedule. The department will retain 10 percent of each estimate until the department accepts the Baseline CPM Schedule.
- (6) The engineer will accept the Baseline CPM based solely on whether the schedule is complete as specified in this section. The engineer's acceptance of the schedule does not modify the contract or validate the schedule.
- (7) The department will not consider requests for contract time extensions as specified in 108.10 or additional compensation for delay specified in 109.4.7 until the department accepts the Baseline CPM schedule.

#### **108.4.4.3 Monthly CPM Updates**

- (1) Submit CPM Updates on a monthly basis after acceptance of the Baseline CPM as follows:
  1. Include actual start dates, completion percentages, and remaining durations for activities started but not completed, and actual finish dates for completed activities, through the final acceptance of the project.
  2. Include additional activities as necessary to depict additions to the contract by changes and logic revisions as necessary to reflect changes in the contractor's plan for prosecuting the work.
  3. Include a narrative report that includes a brief description of monthly progress, changes to the critical path from the previous update, sources of delay, potential problems, work planned for the next 30 calendar days, and changes to the CPM schedule. Changes to the logic of the CPM schedule include the addition or deletion of activities and changes to activity descriptions, original durations, relationships, constraints, calendars, or previously recorded actual dates. Justify changes to the CPM schedule in the narrative by describing associated changes in the planned methods or manner of performing the work or changes in the work itself.
  4. Submit three copies of each CPM Update in a compressed (XER) format electronically, as agreed to with the department.
  5. If additions or changes were made to the CPM schedule since the previous update, submit an updated hard copy of the revised logic diagram.
- (2) Within five business days of receiving each CPM Update, the engineer will provide comments and schedule a meeting as necessary to address comments raised in the engineer's review. Address the engineer's comments and resubmit a revised CPM Update within five business days after the engineer's request.

#### **108.4.4.4 Three-Week Look-Ahead Schedules**

- (1) Submit Three-Week Look-Ahead Schedules on a weekly basis after the notice to proceed (NTP). The schedule can be hand drawn or generated by computer. With each Three-Week Look-Ahead include:
  1. Activities underway and as-built dates for the past week.
  2. Actual as-built dates for completed activities through final acceptance of the project.
  3. Planned work for the upcoming two-week period.
  4. The activities underway and critical RFIs and submittals, based on the CPM schedule.
  5. Details on other activities not individually represented in the CPM schedule.
- (2) On a weekly basis, the department and the contractor shall agree on the as-built dates depicted in the Three-Week Look-Ahead schedule or document all disagreements. Use the as-built dates from the Three-Week Look-Ahead schedules for the month when updating the CPM schedule.

#### **108.4.4.5 Weekly Production Data**

- (1) Provide estimated and actual weekly production rates for items of work on a weekly basis as follows:
  1. Data on the following items by area or station:
    - 1.1. Retaining Walls
      - 1.1.1. Leveling Pads - LF
      - 1.1.2. Set Panels - SF
      - 1.1.3. Parapets - LF
      - 1.1.4. Wall Face - Bay
      - 1.1.5. Tie Backs – Each

- 1.1.6. Anchor Slabs – LF
- 1.1.7. Drilling - Each
- 1.1.8. Coping – LF
- 1.1.9. Footing - LF
- 1.2. Bridge Construction
  - 1.2.1. Footings—Each
  - 1.2.2. Columns—Each
  - 1.2.3. Abutments—Each
  - 1.2.4. Pier Caps—Each
  - 1.2.5. Girder Spans – Each
  - 1.2.6. Decker Spans – Each
  - 1.2.7. Poured Spans – Each
- 1.3. Roadway Excavation—CY per week
- 1.4. Roadway Structural Section
  - 1.4.1. Grading/Subgrade Preparation—SY
  - 1.4.2. Base Material Placement—Ton
  - 1.4.3. Base Material Subgrade Preparation—SY
  - 1.4.4. Asphalt Pavement—Ton
  - 1.4.5. Concrete Pavement – SY
- 1.5. Tunnels
  - 1.5.1. Drilled Shafts – Each
  - 1.5.2. Beam Seat/Cap - LF
  - 1.5.3. Girders - Each
  - 1.5.4. Deck – Percent
- 1.6. Noise Walls
  - 1.6.1. Drill/Set Ground Mounted Posts - Each
  - 1.6.2. Install Ground Mounted Panels - Each
  - 1.6.3. Anchor/Set Structure Mounted Posts - Each
  - 1.6.4. Install Structure Mounted Panels - Each

2. The actual daily production for the past week and the anticipated weekly production for the next week.

- (2) Submit the data in an electronic spreadsheet format at the same time the Three-Week Look-Ahead is submitted. On a weekly basis, the department and the contractor shall agree on the production data or document all disagreements.

#### **108.4.5 Progress Review Meetings**

##### **108.4.5.1 Weekly Progress Review Meetings**

- (1) After completing the weekly submittal of the Three-Week Look-Ahead and production data, attend a weekly meeting to review the submittals with the department. At the meeting, address comments as necessary, and document agreement or disagreement with the department.

##### **108.4.5.2 Monthly Update Review Meetings**

- (1) After submitting the monthly update and receiving the engineer's comments, attend a job-site meeting, as scheduled by the engineer, to review the progress of the schedule. At that meeting, address comments as necessary, and document agreement or disagreement with the department. The monthly meeting will be coordinated to take place on the same day and immediately before or after a weekly meeting, whenever possible.

#### **108.4.6 CPM Progress Schedule Revisions**

- (1) Revision by the contractor if necessary due to changes in the Work or project conditions and authorized by the engineer, a CPM Progress Schedule Revision may be submitted, although the next Monthly CPM Update is not yet due. Prepare the CPM Revision in the same format as required for Monthly CPM Updates, including justification for changes to the schedule. The process for comment and acceptance of a CPM Revision will be the same as for Monthly CPM Updates. If the CPM Revision is accepted, prepare the next monthly update based on the revised CPM. If the CPM Revision is rejected, prepare the next monthly update based on the previous month's update.

(2) **Engineer's Right to Request Revisions**—The engineer will monitor the progress of the work and may request revisions to the CPM schedule. Revise the schedule as requested by the engineer, and submit a CPM Progress Schedule Revision within ten business days of the request. The process for comment and acceptance of a CPM Revision will be the same as for Monthly CPM Updates. The engineer may request that the contractor revise the CPM schedule for one or more of the following reasons:

1. The forecast completion date is scheduled to occur more than 14 calendar days after the contract completion date.
2. An intermediate milestone is scheduled to occur more than 14 calendar days after the date required by the contract.
3. The engineer determines that the progress of the work differs significantly from the current schedule.
4. A contract change order requires the addition, deletion, or revision of activities that causes a change in the contractor's work sequence or the method and manner of performing the work.

**108.4.7 Documentation Required for Time Extension Requests**

(1) To request a time extension to an intermediate milestone date or the contract completion date associated with changes to the work, provide a narrative detailing the work added or deleted and the other activities affected, based on the latest accepted CPM Update. For added work, submit a proposed fragnet of activities to be added or revised in the CPM schedule, indicating how the fragnet is to be tied to the CPM schedule.

(2) To request a time extension to an intermediate milestone date or the contract completion date associated with delays to the work, provide a narrative detailing the affected activities and the cause of the delay, based on the latest accepted CPM Update. Requests for time extensions due to delays should meet the following criteria:

1. For requests to extend the contract completion date, include a description of how the delay affected the project's critical path, based on the latest accepted CPM Update.
2. For requests to extend an intermediate milestone date, include a description of how the delay affected the controlling (longest) path to the milestone, based on the latest accepted CPM Update.
3. The department and the contractor agree that the float is not for the exclusive use or financial benefit of either party. Either party has the full use of the float on a first come basis until it is depleted.

**108.4.8 Payment for CPM Progress Schedule**

(1) The department will pay for measured quantities at the contract unit price for work acceptably completed under the following bid item:

ITEM NUMBER	DESCRIPTION	UNIT
SPV.0060.051	Baseline CPM Progress Schedule	EACH
SPV.0060.052	Monthly CPM Progress Schedule Updates	EACH

(2) The department will only make progress payments for the value of materials, as specified in 109.6.3.2.1, until the Baseline CPM schedule has been submitted. The department will retain ten percent of each estimate until the department accepts the Baseline CPM schedule.

(3) The department will only make progress payments for the value of materials, as specified in 109.6.3.2.1, until the Monthly CPM schedule updates have been submitted. The department will retain ten percent of each estimate until the department accepts the Monthly CPM schedule update.

(4) Payment is full compensation for all work required under these bid items. The department will pay the contract unit price for the Baseline CPM schedule after the department accepts the schedule. Then, the department will pay the contract unit price for each Monthly CPM Update acceptably completed.

sef-108-005 (20180404)

**89. Traffic Control Close-Open Freeway Entrance Ramp, Item SPV.0060.053.**

**A Description**

This special provision describes closing and re-opening a freeway entrance ramp and associated auxiliary lane.

**B (Vacant)**

**C Construction**

Install or reposition traffic control devices required for closing a freeway entrance ramp and adjacent auxiliary lanes. Remove or return traffic control devices to their previous configuration when the closure is no longer required.

**D Measurement**

The department will measure Traffic Control Close-Open Freeway Entrance Ramp by each individual ramp closure, acceptably completed.

**E Payment**

The department will pay for measured quantities at the contract unit price under the following bid item:

ITEM NUMBER	DESCRIPTION	UNIT
SPV.0060.053	Traffic Control Close-Open Freeway Entrance Ramp	EACH

Payment is full compensation for daily surveillance; preparing and submitting the daily surveillance report with hourly metered tickets; mobilization; sweeping; and disposing of materials. Traffic Control devices will be paid separately.

sef-643-001 (20180627)

**90. Traffic Control Full Freeway Closure, Item SPV.0060.054.**

**A Description**

This special provision describes closing and re-opening a freeway or expressway.

**B (Vacant)**

**C Construction**

Install or reposition traffic control devices required for a full freeway closure. Remove or return traffic control devices to their previous configuration when the full closure is no longer required.

**D Measurement**

The department will measure Traffic Control Full Freeway Closure by each individual freeway closure that is set up and later removed in each traffic direction, acceptably completed.

**E Payment**

The department will pay for measured quantities at the contract unit price under the following bid item:

ITEM NUMBER	DESCRIPTION	UNIT
SPV.0060.054	Traffic Control Full Freeway Closure	EACH

Payment is full compensation for closing and re-opening the freeway. Traffic Control devices will be paid separately.

sef-643-003 (20180627)

**91. Mobilization Emergency Pavement Repair, Item SPV.0060.055.**

**A Description**

This special provision describes furnishing and mobilizing personnel, equipment, traffic control, and materials to the project site to repair the existing pavement for emergencies as the engineer directs. An emergency is a sudden occurrence of a serious and urgent nature, beyond normal maintenance of the existing pavement.

**B (Vacant)**

**C Construction**

Mobilize with sufficient personnel, equipment, traffic control, materials, and incidentals on the jobsite within 4 hours of the engineer's written order to repair the existing pavement on an emergency basis.

## D Measurement

The department will measure Mobilization Emergency Pavement Repair as each individual mobilization acceptably completed. The department will not include delivering and installing pavement repair or maintenance materials provided for in specific contract bid items. All traffic control items used for each Mobilization will be considered incidental to the Mobilization.

## E Payment

The department will pay for measured quantities at the contract unit price under the following bid item:

ITEM NUMBER	DESCRIPTION	UNIT
SPV.0060.055	Mobilization Emergency Pavement Repair	EACH

Payment is full compensation for the staged moving of personnel, moving equipment, setting up and removing traffic control, traffic control materials, and moving materials. The department will pay separately for delivery and installation of pavement repair materials under the other bid items in this contract. The department will not pay separately for traffic control items and materials even though they may be included in other bid items in this contract and will consider them incidental to each Mobilization.

sef-999-025 (20170310)

## 92. Field Facilities Office Space, Item SPV.0060.056.

### A Description

This special provision describes furnishing, equipping, and maintaining a field office as required in the contract at engineer-approved locations conforming to standard spec 642 and as follows.

### B Materials

Provide Field Facilities Office Space conforming to standard spec 642.2.1 except delete paragraphs (1), (8), and (10).

*Replace standard spec 642.2.1(4) with the following:*

Provide and maintain suitable interior sanitary facilities conforming to State and local health requirements, in clean and good working condition, and stock with sanitary supplies for the duration of the contract. Furnish office space in an existing office building or existing building converted to office space with a minimum of 2,000 square feet. The facility shall have no fee parking with a minimum parking for 20 cars. The space shall include a meeting room with a minimum of 350 square feet. The exterior door(s) shall have locks in good working order and keys provided for all field staff. The office space shall be located within 2 miles of the construction project.

Equip the office as specified in standard spec 642.2.2.1 except delete paragraph (1) and (5) and add the following:

1. Ten suitable office desks with drawers and locks.
2. Ten ergonomically correct office chairs in working condition with at a minimum: 5-legged base with casters, seat adjustable from 15 to 22 inches from the floor with a seamless waterfall, rounded, front edge, and high backrest with no arms or adjustable arms.
3. Six 6-foot folding tables.
4. Two 10-foot folding tables.
5. Ten 2-drawer file cabinets.
6. Six 4-shelf bookcases.
7. Thirty folding chairs.

Provide for the professional cleaning of the field office during regular business hours twice monthly. Provide clearly marked recycling and waste receptacles within the field office, and separate recycling and waste dumpsters near the field office. Cover outdoor containers to keep out rain, snow, and wind-driven debris. Provide regularly scheduled recycling and waste pick-up.

### C Construction

Conform to standard spec 642.3 except delete paragraph (2).

**D Measurement**

The department will measure the Field Facilities Office Space as each office, acceptably completed.

**E Payment**

The department will pay for measured quantities at the contract unit price under the following bid item:

ITEM NUMBER	DESCRIPTION	UNIT
SPV.0060.056	Field Facilities Office Space	EACH

Payment is full compensation for providing, equipping, securing, and maintaining the facility; for parking, for telecommunications equipment, installation, and service fees; and for providing bottled water, utilities, fuel, ventilation, and toilet facilities as required, either independently or jointly with the field laboratory, for the time specified in standard spec 642.3.

The department will pay for the cost of telecommunications usage fees incurred by department staff.

**93. Utility Line Opening (ULO), Item SPV.0060.057.**

**A Description**

This special provision describes excavating to uncover utilities/infrastructure for the purpose of determining location and elevation and potential conflicts with proposed work as shown on the plans or as directed by the engineer. The location of existing utilities and infrastructure needed to complete the contract work shall be addressed independent of this provision. This item does not remove the contractor's obligation to locate utilities as specified by Wisconsin Administrative code Trans 220.

**B (Vacant)**

**C Construction**

Comply with s.182.0175 (2), Stats., with respect to precautions to be taken to avoid and prevent damage to utility facilities.

All ULO shall be approved by the engineer. Notify the utility engineers or their agents of this work a minimum of 3 days prior to the work so they may be present when the work is completed. Notify the infrastructure/utility owner or their agents 3 working days in advance so that they may be present when excavation work commences.

Perform the excavation in such a manner that the utility in question is not damaged and the safety of the workers is not compromised.

Perform the utility line opening at least 10 days in advance of proposed construction to allow any conflicts to be resolved with minimal disruption. Allow the engineer a minimum of 3 working days after ULO information is received to review and respond with potential design inquiries. Provide documentation to the engineer including coordinates/elevations or referenced to alignment/offset. Document the size and/or diameter, composition, and a description of each infrastructure/utility. Supply digital photographs of the uncovered infrastructure to the engineer for future reference.

Backfill the excavation with suitable backfill, thoroughly compact, replace pavement over utility line opening trenches which are within the staged traffic area as directed by the engineer. Replace pavement and open to traffic within 24 hours of the excavation.

**D Measurement**

The department will measure Utility Line Opening (ULO) as each individual ULO, acceptably completed.

Where utilities are within 6 feet of each other at a potential conflict location, only one utility line opening will be called for. In these cases, a single utility line opening will be considered full payment to locate multiple utilities. ULO include a trench up to 10 feet long as measured at the trench bottom, and of any depth required to locate the intended utility.

**E Payment**

The department will pay for measured quantities at the contract unit price under the following bid item:

ITEM NUMBER	DESCRIPTION	UNIT
SPV.0060.057	Utility Line Opening (ULO)	EACH



Payment is full compensation for the excavation required to expose the utility line; measuring lateral and depth measurements of the utility line; providing required documentation of measurements to the engineer; backfilling with engineer approved material; compacting the backfill material; restoring the site; cleanup, and maintenance of ULO location during construction.

Existing pavement, concrete curb and gutter, and sidewalk removals necessary to facilitate utility line openings are not considered part of or paid for under ULO but are measured and paid for separately as removal items. Granular backfill, pavement replacement material, concrete curb, gutter, and sidewalk items will also be considered separate from ULO and will be measured and paid for separately.

#### **94. Section Corner Monuments Special, Item SPV.0060.058.**

##### **A Description**

Coordinate with Southeastern Wisconsin Regional Planning Commission (SEWRPC) for the perpetuation and replacement of a section corner (Public Land Survey System - PLSS) monument.

##### **B Materials**

SEWRPC will provide a pre-cast concrete monument or brass disk to be used to mark the PLSS corner.

Furnish base aggregate dense materials that conform to standard spec 305 and concrete, asphalt, topsoil, or other materials depending on the surface surrounding the corner.

##### **C Construction**

SEWRPC will perpetuate existing section corner monument. The contractor is responsible to coordinate with SEWRPC and the WisDOT Project Manager throughout the perpetuation and replacement process. The engineer will contact SEWRPC at (262) 953-4295 at least two weeks before starting construction operations or the preconstruction meeting to allow for section corner monument perpetuation.

Contractor must excavate and completely remove the existing monument. Contractor is responsible for providing a backfilled 3 to 4 foot deep hole where existing monument was removed. Contractor is responsible to coordinate the materials and methodology to complete the construction of the surface surrounding the monument. This may include but is not limited to a 2' x 2' "box out" or 24" diameter core hole in concrete, asphalt pavement/paving rings, coring to facilitate poured in place monuments, topsoil, seed and mulching or other materials or methodologies as agreed to by the contractor and SEWRPC.

Contractor must contact the engineer and SEWRPC at least two weeks prior to work near any section corner monument.

##### Contact Information:

Attn: Rob Merry (Chief Surveyor)  
Southeastern Wisconsin Regional Planning Commission  
W239 N1812 Rockwood Drive  
P.O. Box 1607  
Waukesha, WI 53187-1607  
Phone (262) 953-4289  
Cell (920) 912-1036  
Fax (262) 547-1103  
E-mail: [rmerry@sewrpc.org](mailto:rmerry@sewrpc.org)

Attn: Andy Traeger (Construction Coordinator)  
Southeastern Wisconsin Regional Planning Commission  
W239 N1812 Rockwood Drive  
P.O. Box 1607  
Waukesha, WI 53187-1607  
Phone (262) 953-4296  
Cell (262) 853-8463  
Fax (262) 547-1103  
E-mail: [atraeger@sewrpc.org](mailto:atraeger@sewrpc.org)

**D Measurement**

The department will measure Section Corner Monuments Special by each individual unit, acceptably completed.

**E Payment**

The department will pay for measured quantities at the contract unit price under the following bid item:

ITEM NUMBER	DESCRIPTION	UNIT
SPV.0060.058	Section Corner Monuments Special	EACH

Payment is full compensation for furnishing all excavating; removal of existing monument, for placing and compacting backfill material; for disposing of surplus materials; for concrete or asphalt material, finishing of roadway or other surfaces, and for furnishing all coordination with SEWRPC.

**95. Remove and Reset Cable Barrier Post, Item SPV.0060.059.**

**A Description**

This special provision describes removing and resetting cable barrier posts and bases.

**B Materials**

If existing cable barrier system posts are damaged during removal, furnish new materials according to the manufacturer’s specifications.

**C Construction**

Remove and reset cable barrier post and base for cross culvert replacement.

Dismantle, remove, and sort according to pertinent requirements of standard spec 614.3.9. Salvage hardware and system elements and stockpile on site.

Reset the cable barrier system post and base according to the manufacturer’s specifications.

**D Measurement**

The department will measure Remove and Reset Cable Barrier Post by each post and base acceptably completed.

**E Payment**

The department will pay for measured quantities at the contract unit price under the following bid item:

ITEM NUMBER	DESCRIPTION	UNIT
SPV.0060.059	Remove and Reset Cable Barrier Post	EACH

Payment is full compensation for dismantling and stockpiling system posts and bases, replacing posts and bases damaged during salvaging, disposing of damaged posts and bases, and for resetting posts and bases.

**96. Curb Ramp Grading and Shaping, Item SPV.0060.060.**

**A Description**

This special provision describes excavating, grading, filling, shaping, and compacting as necessary to construct each curb ramp location conforming to standard spec 205, 208, 211, 305, as the plans show, and as follows.

**B Materials**

Furnish materials as the plans show and engineer directs conforming to the standard specs for the following:

Common Excavation	standard spec 205.2
Borrow	standard spec 208.2

**C Construction**

Construct the final subgrade for the curb ramp at the locations on the plans and as the engineer directs. Dispose of all surplus and unsuitable material as specified in standard spec 205.3.12.

**D Measurement**

The department will measure Curb Ramp Grading and Shaping as each individual plan location, acceptably completed.

**E Payment**

The department will pay for measured quantities at the contract unit price under the following bid item:

ITEM NUMBER	DESCRIPTION	UNIT
SPV.0060.060	Curb Ramp Grading and Shaping	EACH

Payment is full compensation for all excavating, grading, placing borrow, shaping, and compacting.

Sidewalk removal, construction staking, curb ramp detectable warning field, and concrete sidewalk will be paid under respective contract bid items.

**97. Concrete Barrier Transition to Curb, Item SPV.0060.101.**

**A Description**

This special provision describes providing Concrete Barrier Transition to Curb.

**B Materials**

Furnish material conforming to standard spec 603 Concrete Barrier.

**C Construction**

Construct barrier and shoulder according to standard spec 603. Transition Concrete Curb and Gutter 6-inch sloped 30-inch type G to Concrete Barrier single-faced at the locations shown on the plans. Reconstruct the adjacent shoulder integral to the Concrete Barrier and Concrete Barrier Transition to Curb sections.

**D Measurement**

The department will measure Concrete Barrier Transition to Curb by each transition, acceptably completed.

**E Payment**

The department will pay for measured quantities at the contract unit price under the following bid item:

ITEM NUMBER	DESCRIPTION	UNIT
SPV.0060.101	Concrete Barrier Transition to Curb	EACH

Payment is full compensation for providing the specified transition, for excavating and backfilling; and for disposing of excess material; for restoring the grade. The 4.5 foot shoulder section adjacent to the Concrete Barrier Transition to Curb section is included in the Concrete Barrier Transition to Curb bid item.

**98. Fastening Sewer Access Covers, Item SPV.0060.102.**

**A Description**

This special provision describes sealing, maintaining, and removing sealant for sewer access covers.

**B Materials**

Furnish preformed butyl rubber based sealant conforming to ASTM C990 Section 6.2. Size the preformed joint sealant to fill the joint to 50% of its annular volume when assembled.

**C Construction**

Open the sewer access cover, inspect the frame and grate, and remove material that will interfere with the sealant application from the cover and casting. Apply sealant in a continuous ring around the frame without stretching. Knead the ends together with no overlap.

Monitor performance during the project and maintain as needed. Remove sealant after traffic is shifted into its final configuration.

**D Measurement**

The department will measure Fastening Sewer Access Covers as each individual cover, acceptably completed.

**E Payment**

The department will pay for measured quantities at the contract unit price under the following bid item:

ITEM NUMBER	DESCRIPTION	UNIT
SPV.0060.102	Fastening Sewer Access Covers	EACH

Payment is full compensation for providing and maintaining sealed covers; and removing sealant.  
sef-611-015 (20180104)

**99. Reset Existing Bearings, Item SPV.0060.103.**

**A Description**

This special provision describes raising the girders on Structure B-67-245 and resetting the bearings as directed by the engineer, and as hereinafter provided.

**B (Vacant)**

**C Construction**

Accomplish the work in such a way so that no damage is done to the bearings, the concrete girders, or the concrete bridge elements that are to remain in place.

Bearings may be reset one at a time. If jacking girders one at a time, jack the adjacent girder or girders one-half the amount that the girder being reset is jacked. The jacking height on the girder for resetting the bearing shall not exceed a maximum of 1/4-inch.

If resetting bearings is done simultaneously with replacing bearings, jack beams according to the jacking plan required for removing and replacing the bearings.

Clean debris from the concrete beam seat under the finished bearing location. Before jacking, clean the underside of the masonry plate if it has been separated from the elastomeric material, including removal of laminar rust and debris.

When the girder is lifted, move the elastomeric pad back to plumb and then lower the bearing.

**D Measurement**

The department will measure Reset Existing Bearings as each individual unit, acceptably completed.

**E Payment**

The department will pay for measured quantities at the contract unit price under the following bid item:

ITEM NUMBER	DESCRIPTION	UNIT
SPV.0060.103	Reset Existing Bearings	EACH

Payment is full compensation for jacking and supporting the girders, removing the existing welds, resetting the bearings, and for placing the new welds.

- 100. Install Poles Type 9, Item SPV.0060.201;  
 Install Poles Type 9 Special, Item SPV.0060.202;  
 Install Poles Type 10, Item SPV.0060.203;  
 Install Poles Type 10 Special, Item SPV.0060.204;  
 Install Poles Type 12, Item SPV.0060.205;  
 Install Poles Type 13, Item SPV.0060.206;  
 Install Monotube Arms 15-FT, Item SPV.0060.207;  
 Install Monotube Arms 25-FT, Item SPV.0060.208;  
 Install Monotube Arms 35-FT-Special, Item SPV.0060.209;  
 Install Monotube Arms 45-FT-Special, Item SPV.0060.210;  
 Install Monotube Arms 50-FT, Item SPV.0060.211;  
 Install Monotube Arms 55-FT, Item SPV.0060.212;  
 Install Luminaire Arms Steel 15-FT, Item SPV.0060.213.**

**A Description**

This special provision describes installing state furnished materials conforming to standard spec 657, details shown in the plans, and as modified in this special provision.

**B Materials**

The department will furnish the monotube poles, monotube arms and luminaire arms.

Provide all other needed materials in conformance with standard spec 651.2, 652.2, 653.2, 654.2, 655.2, 656.2, 657.2, 658.2 and 659.2.

**C Construction**

Perform work according to standard spec 651.3, 652.3, 653.3, 654.3, 655.3, 656.3, 657.3, 658.3 and 659.3 except as specified below.

Touch-up and repair damage to any black equipment with matching material. All black equipment, whether department or contractor provided, must be touched-up, repaired, and accepted by the department prior to traffic signal turn-on.

**D Measurement**

The department will measure Install [Equipment] at the contract unit price, acceptably completed.

**E Payment**

The department will pay for measured quantities at the contract unit price under the following bid item:

ITEM NUMBER	DESCRIPTION	UNIT
SPV.0060.201	Install Poles Type 9	EACH
SPV.0060.202	Install Poles Type 9 Special	EACH
SPV.0060.203	Install Poles Type 10	EACH
SPV.0060.204	Install Poles Type 10 Special	EACH
SPV.0060.205	Install Poles Type 12	EACH
SPV.0060.206	Install Poles Type 13	EACH
SPV.0060.207	Install Monotube Arms 15-FT	EACH
SPV.0060.208	Install Monotube Arms 25-FT	EACH
SPV.0060.209	Install Monotube Arms 35-FT-Special	EACH
SPV.0060.210	Install Monotube Arms 45-FT-Special	EACH
SPV.0060.211	Install Monotube Arms 50-FT	EACH
SPV.0060.212	Install Monotube Arms 55-FT	EACH
SPV.0060.213	Install Luminaire Arms Steel 15-FT	EACH

Payment is full compensation for installing all materials, including all associated hardware, fittings, mounting devices, and attachments necessary to completely install the pole and arms.

**101. Traffic Signal Reflective Backplate 3S, Item SPV.0060.214;  
Traffic Signal Reflective Backplate 4S, Item SPV.0060.215.**

**A Description**

This special provision describes installing reflective backplates on traffic signal heads, details shown in the plans.

**B Materials**

Furnish reflective backplates in compliance with the department's Electrical Qualified Product List.

**C Construction**

Perform work according to standard spec 658.3 and as detailed in the plans.

**D Measurement**

The department will measure Traffic Signal Reflective Backplate as each individual unit, acceptably completed.

**E Payment**

The department will pay for measured quantities at the contract unit price under the following bid item:

ITEM NUMBER	DESCRIPTION	UNIT
SPV.0060.214	Traffic Signal Reflective Backplate 3S	EACH
SPV.0060.215	Traffic Signal Reflective Backplate 4S	EACH

Payment is full compensation for furnishing and installing all materials, including all associated hardware, fittings, mounting devices, and attachments necessary to install the reflective backplates.

**102. Trnspt & Install State Furn Traffic Signal Cabinet STH 318 & Silvernail Road, Item SPV.0060.216;  
Trnspt & Install State Furn Traffic Signal Cabinet IH 94 EB Ramps & STH 318, Item SPV.0060.217;  
Trnspt & Install State Furn Traffic Signal Cabinet IH 94 WB Ramps & STH 318, Item SPV.0060.218;  
Trnspt & Install State Furn Traffic Signal Cabinet IH 94 EB Ramps & CTH T, Item SPV.0060.219;  
Trnspt & Install State Furn Traffic Signal Cabinet IH 94 WB Ramps & CTH T, Item SPV.0060.220.**

**A Description**

This special provision describes the transporting and installing of department furnished materials for traffic signals.

**B Materials**

Use materials furnished by the department including: the traffic signal controller and the traffic signal cabinet.

Pick up the department furnished materials at the department's Electrical Shop located at 935 South 60th Street, West Allis. Notify the department's Electrical Field Unit at (414) 266-1170 and make arrangements for picking up the department furnished materials five (5) working days prior to picking the materials up.

Provide all other needed materials in conformance with standard spec 651.2, 652.2, 653.2, 654.2, 655.2, 656.2, 657.2, 658.2 and 659.2.

**C Construction**

Perform work according to standard spec 651.3, 652.3, 653.3, 654.3, 655.3, 656.3, 657.3, 658.3 and 659.3 except as specified below.

Request a signal inspection of the completed signal installation to the engineer at least five working days prior to the time of the requested inspection. The department's Region Electrical personnel will perform the inspection.

Coordinate directly with the department's traffic signal cabinet vendor {TAPCO at (262) 814-7327 or rickk@tapconet.com / TCC at (651) 439-1737 or mallwood@trafficcontrolcorp} to schedule the cabinet acceptance testing. Coordinate with the department's Electrical Field Unit at (414) 266-1170 to participate in the acceptance testing. The department has final determination of the cabinet acceptance testing date and time.

**D Measurement**

The department will measure Trnspt & Install State Furn Traffic Signal Cabinet [Location] as each individual unit of work, in place and accepted.

**E Payment**

The department will pay for measured quantities at the contract unit price under the following bid item:

ITEM NUMBER	DESCRIPTION	UNIT
SPV.0060.216	Trnspt & Install State Furn Traffic Signal Cabinet STH 318 & Silvernail Road	EACH
SPV.0060.217	Trnspt & Install State Furn Traffic Signal Cabinet IH 94 EB Ramps & STH 318	EACH
SPV.0060.218	Trnspt & Install State Furn Traffic Signal Cabinet IH 94 WB Ramps & STH 318	EACH
SPV.0060.219	Trnspt & Install State Furn Traffic Signal Cabinet IH 94 EB Ramps & CTH T	EACH
SPV.0060.220	Trnspt & Install State Furn Traffic Signal Cabinet IH 94 WB Ramps & CTH T	EACH

Payment is full compensation for transporting and installing the traffic signal controller and the traffic signal cabinet; for furnishing and installing all other items necessary (such as, wire nuts, splice kits and/or connectors, tape, insulating varnish, ground lug fasteners, etc.) to make the proposed system complete from the source of supply to the most remote unit and for clean-up and waste disposal.

- 103. Trnspt & Install State Furn EVP Heads & Con Light STH 318 & Silvernail Road, Item SPV.0060.221;**
- Trnspt & Install State Furn EVP Heads & Con Light IH 94 EB Ramps & STH 318, Item SPV.0060.222;**
- Trnspt & Install State Furn EVP Heads & Con Light IH 94 WB Ramps & STH 318, Item SPV.0060.223;**
- Trnspt & Install State Furn EVP Heads & Con Light IH 94 EB Ramps & CTH T, Item SPV.0060.224;**
- Trnspt & Install State Furn EVP Heads & Con Light IH 94 WB Ramps & CTH T, Item SPV.0060.225.**

**A Description**

This special provision describes the transporting and installing of department furnished Emergency Vehicle Preemption (EVP) Detector Heads, confirmation lights, and mounting brackets at STH 318 & Silvernail Road, IH 94 EB Ramps & STH 318, IH 94 WB Ramps & STH 318, IH 94 EB Ramps & CTH T, and IH 94 WB Ramps & CTH T.

**B Materials**

Pick up the department furnished materials at the department's Electrical Shop located at 935 South 60th Street, West Allis. Notify the department's Electrical Field Unit at (414) 266-1170 and make arrangements for picking up the department furnished materials five working days prior to picking the materials up.

**C Construction**

Install the EVP detector heads and confirmation lights as shown on the plans. The department will determine the exact location to ensure that the installation does not create a sight obstruction. Mount the EVP detector heads and wire them per manufacturer instructions. Mount the confirmation lights and wire them with 3-14 AWG Traffic Signal cable in a continuous run from the cabinet to the confirmation lights. For a cabinet that is not operating the signal, the contractor will terminate the ends and install the discriminators and card rack in the cabinet. If the cabinet is operating the signal, the cabinet wiring will be done by the department.

Notify the department's Electrical Shop at (414) 266-1170 upon completion of the installation of the Emergency Vehicle Preemption (EVP) Detector Heads with confirmation lights.

## D Measurement

The department will measure transporting and installing of department furnished Emergency Vehicle Preemption (EVP) Detector Heads, confirmation lights, and mounting brackets as each individual unit of work, in place and accepted.

## E Payment

The department will pay for measured quantities at the contract unit price under the following bid item:

ITEM NUMBER	DESCRIPTION	UNIT
SPV.0060.221	Trnspt & Install State Furn EVP Heads & Con Light STH 318 & Silvernail Road	EACH
SPV.0060.222	Trnspt & Install State Furn EVP Heads & Con Light IH 94 EB Ramps & STH 318	EACH
SPV.0060.223	Trnspt & Install State Furn EVP Heads & Con Light IH 94 WB Ramps & STH 318	EACH
SPV.0060.224	Trnspt & Install State Furn EVP Heads & Con Light IH 94 EB Ramps & CTH T	EACH
SPV.0060.225	Trnspt & Install State Furn EVP Heads & Con Light IH 94 WB Ramps & CTH T	EACH

Payment is full compensation for transporting and installing of department furnished Emergency Vehicle Preemption (EVP) Detector Heads, confirmation lights, and mounting brackets.

- 104. Trnspt Traffic Signals & Inter Lighting Materials STH 318 & Silvernail Road, Item SPV.0060.226;**  
**Trnspt Traffic Signals & Inter Lighting Materials IH 94 EB Ramps & STH 318, Item SPV.0060.227;**  
**Trnspt Traffic Signals & Inter Lighting Materials IH 94 WB Ramps & STH 318, Item SPV.0060.228;**  
**Trnspt Traffic Signals & Inter Lighting Materials IH 94 EB Ramps & CTH T, Item SPV.0060.229;**  
**Trnspt Traffic Signals & Inter Lighting Materials IH 94 WB Ramps & CTH T, Item SPV.0060.230.**

## A Description

This special provision describes the transporting of department furnished monotube poles, monotube arms, and monotube luminaire arms.

## B Materials

Transport materials furnished by the department including: Monotube poles, monotube arms and monotube luminaire arms (to be installed on monotube assemblies).

Pick up the department furnished materials at the department's Electrical Shop located at 935 South 60th Street, West Allis. Notify the department's Electrical Field Unit at (414) 266-1170 and make arrangements for picking up the department furnished materials five working days prior to picking the materials up.

Provide all other needed materials in conformance with standard spec 651.2, 652.2, 653.2, 654.2, 655.2, 656.2, 657.2, 658.2 and 659.2.

## C Construction

Perform work according to standard spec 651.3, 652.3, 653.3, 654.3, 655.3, 656.3, 657.3, 658.3 and 659.3.

## D Measurement

The department will measure Trnspt Traffic Signals & Inter Lighting Materials [Location] as each individual unit of work, in place and accepted.

## E Payment

The department will pay for measured quantities at the contract unit price under the following bid item:

ITEM NUMBER	DESCRIPTION	UNIT
SPV.0060.226	Trnspt Traffic Signals & Inter Lighting Materials STH 318 & Silvernail Road	EACH
SPV.0060.227	Trnspt Traffic Signals & Inter Lighting Materials IH 94 EB Ramps & STH 318	EACH
SPV.0060.228	Trnspt Traffic Signals & Inter Lighting Materials IH 94 WB Ramps & STH 318	EACH
SPV.0060.229	Trnspt Traffic Signals & Inter Lighting Materials IH 94 EB Ramps & CTH T	EACH
SPV.0060.230	Trnspt Traffic Signals & Inter Lighting Materials IH 94 WB Ramps & CTH T	EACH



Payment is full compensation for transporting the monotube poles, monotube arms and monotube luminaire arms (to be installed on monotubes). Installation of these materials is included under a separate pay item.

**105. Trnspt & Install S-F Radar Detection System IH 94 EB Ramps & CTH T, Item SPV.0060.231;  
Trnspt & Install S-F Radar Detection System IH 94 WB Ramps & CTH T, Item SPV.0060.232.**

**A Description**

This special provision describes the transporting and installing of department furnished Radar Detection System on monotube poles or arms.

**B Materials**

Pick up the department furnished Radar System at the department's electrical shop located at 935 South 60th Street, West Allis. Notify the department's electrical field unit (EFU) at (414) 266-1170 to make arrangements for picking up the department furnished materials at least five working days prior to material pick-up.

**C Construction**

Install the department furnished pole/arm mounting brackets, extension arms (if required), and radar units per manufacturer recommendations in the locations determined by the department.

Install the power and communication cable to run continuously (without splices) from the traffic signal cabinet to the pole handhole plus an additional 16-feet in each pull box and an extra 10-feet in the pole handhole. Install the detector unit cable whip from the detector unit to the pole handhole. Splice the detector unit cable whip to the power and communication cable in the pole handhole using the provided junction box.

Mark each end of the lead in the traffic signal cabinet and each cable in the pole handhole to indicate the equipment label (i.e., RA1, RA2, etc.) on the plans. For a cabinet that is not operating the signal, the contractor will terminate the ends. If the cabinet is operating the signal, the cabinet wiring will be done by the department.

Notify department's Electrical Shop at (414) 266-1170 upon completion of the installation and aiming of the radar units.

The department will provide the vendor's contact information. Coordinate directly with the department's radar detection system vendor to arrange for the vendor to program the radar detection system on site. Notify the department and vendor at least five working days prior to the date of programming. Assist the department and vendor with fine adjusting of the radar units during the radar system programming, if necessary.

**D Measurement**

The department will measure Transporting and Installing State Furnished Radar Detection System as each individual unit of work for each intersection, acceptably completed.

**E Payment**

The department will pay for measured quantities at the contract unit price under the following bid items:

ITEM NUMBER	DESCRIPTION	UNIT
SPV.0060.231	Trnspt & Install S-F Radar Detection System IH 94 EB Ramps & CTH T	EACH
SPV.0060.232	Trnspt & Install S-F Radar Detection System IH 94 WB Ramps & CTH T	EACH

Payment is full compensation for transporting and installing the radar detection system, cable, mounting hardware, and radar units; and assisting the department and vendor during the radar system programming.

## 106. Airport Obstruction Lights L810, Item SPV.0060.233.

### A Description

This work consists of furnishing and installing obstruction lights according to the contract documents and shall include furnishing and installing supports as required in the contract documents, and mounting, leveling, conduit, wiring, and power source. This work also includes all wire and cable connections, the furnishing and installing of all necessary conduits and fittings, insulators, and painting. In addition, it includes the servicing and testing of the installation and all incidentals necessary to place the lights in operation as completed units. This work includes installation of breakers in traffic signal control cabinets and field modification of traffic signal poles, as specified in the contract documents.

### B Materials

Furnish materials according to the pertinent requirements of standard spec 651.2.

The obstruction lights shall conform to the requirements of AC 150/5345-43, Specification for Obstruction Lighting Equipment, shall have the prior approval of the FAA, and be listed in the latest edition of Advisory Circular (AC) 150/5345-53D Appendix 3.

All other electrical equipment and materials shall be subject to acceptance through manufacturer's certification of compliance as listed by Underwriters Laboratories and as suitable for the purpose specified.

Obstruction lights shall be omni-directional, red, steady-burning, low-intensity, single lighting unit which is designed to operate on 120VAC circuit. The light intensity must be at least 30 candelas and provided by an LED light source. The weather and corrosion resistant housing shall be equipped with a 1-inch bottom hub. Obstruction lighting unit shall have a 5-year manufacturer's warranty.

Furnish rigid metal conduit and power conductors according to standard spec 652.2 and 655.2. Furnish wiring and fusing according to standard spec 659.2.

### C Construction

Conform to standard spec 651.3.

Mount the obstruction lights on combination traffic signal/roadway lighting poles, at the location shown in the contract documents. Field drill combination pole approximately 2-inches below the upper luminaire arm clamp. De-burr hole, remove filings and metal plug from base of pole. Install bushing, rigid metal conduit nipples, and rigid metal conduit body as indicated in plans. Install each obstruction light with its hub at least 6-inches above and away from the pole cap. Confirm that obstruction lights, conduits, and conduit body are plumb before pulling conductors.

Install separate 120V, 1P-15A, 22 KAIC breaker in each traffic signal cabinet that will be powering obstruction lighting; update panel legend. Use terminal blocks in traffic signal cabinets as necessary to have the obstruction lighting circuit controlled in the same manner as the roadway lighting circuit and as necessary to install conductors from the traffic signal cabinet to base of multiple combination poles without splices. In the base of combination poles install insulated terminal blocks, in-line fuse holders, and circuit tags for obstruction lighting circuits in the same manner as non-freeway lighting unit pole wiring for 3-Wire 120V circuits in SDD 9E3.

Pull obstruction lighting conductors in the same conduit as roadway lighting circuit conductors; pull obstruction lighting and lighting at the same time. Furnish all necessary labor and materials and make complete electrical connection from breaker to obstruction light according to the contract documents.

The installation shall be fully tested by continuous operation for not less than 1/2 hour as a completed unit prior to acceptance. Each obstruction shall be tested to respond to photocell activation a minimum of ten times.

### D Measurement

The department will measure Airport Obstruction Lights L810 as each individual unit of work, acceptably completed.

### E Payment

The department will pay for measured quantities at the contract unit price under the following bid item:

ITEM NUMBER	DESCRIPTION	UNIT
SPV.0060.233	Airport Obstruction Lights L810	EACH

Payment is full compensation for all preparation, assembly and furnishing and installing all materials including obstruction lights, conduit, conductors, labeling, fusing, terminal blocks; servicing and testing; and furnishing and installing traffic signal cabinet breakers.

**107. Concrete Control Cabinet Bases Type 9 Special Super P, Item SPV.0060.234.**

**A Description**

Work under this specification shall be done according to standard spec 654, contract plan detail, and these special provisions.

**B Materials**

Materials shall be according to standard spec 654.

**C Construction**

Construction shall be according to standard spec 654.

**D Measurement**

The department will measure Concrete Control Cabinet Bases Type 9 Special Super P bid item as each individual base, acceptably completed.

**E Payment**

The department will pay for measured quantities at the contract unit price under the following bid item:

ITEM NUMBER	DESCRIPTION	UNIT
SPV.0060.234	Concrete Control Cabinet Bases Type 9 Special Super P	EACH

Payment is full compensation for providing concrete bases; for embedded conduit and electrical components; for anchor rods, nuts, and washers; for bar steel reinforcement, if required; for excavating, backfilling, and disposing of surplus materials.

**108. Temporary EVP System STH 318 & Silvernail Road, Item SPV.0060.235;  
Temporary EVP System IH 94 EB Ramps & STH 318, Item SPV.0060.236;  
Temporary EVP System IH 94 WB Ramps & STH 318, Item SPV.0060.237;  
Temporary EVP System IH 94 EB Ramps & CTH T, Item SPV.0060.238;  
Temporary EVP System IH 94 WB Ramps & CTH T, Item SPV.0060.239.**

**A Description**

This special provision describes furnishing, installing, and maintaining temporary EVP systems at the temporary signalized intersections as shown in the plans.

**B Materials**

Furnish an emergency vehicle preemption system compatible with the local municipality systems and users.

**C Construction**

The Temporary EVP System, as shown in the temporary traffic signal plans or as directed by the engineer, shall be complete in place, tested, and in full operation during each stage and sub-stage of construction.

Install the temporary EVP system as shown in the plans and according to the manufacturer's recommendations. Determine a suitable location for the temporary EVP detectors for each stage and sub-stage of construction. Detectors may be mounted on the temporary traffic signal span wire or wood poles. Relocate the temporary EVP detectors to a suitable location if construction activities and/or construction staging changes impede the detector operation. Arrange for testing of equipment prior to acceptance of the installation for each construction stage.

All cables associated with the temporary EVP system shall be routed to the cabinet. Each lead shall be appropriately marked as to which EVP channel it is associated.

Periodic adjustment and/or moving of the temporary EVP detectors may be required due to changes in traffic control, staging, or other construction operations.

Ensure that the temporary EVP system stays in clean working order. Periodic cleaning of the equipment may be required due to dirt and dust build-up.

Remove the temporary EVP system upon project completion.

Provide the engineer records of all EVP settings used during construction.

**D Measurement**

The department will measure Temporary EVP System [Location] as each individual unit of work for each intersection, acceptably completed.

**E Payment**

The department will pay for measured quantities at the contract unit price under the following bid items:

ITEM NUMBER	DESCRIPTION	UNIT
SPV.0060.235	Temporary EVP System STH 318 & Silvernail Road	EACH
SPV.0060.236	Temporary EVP System IH 94 EB Ramps & STH 318	EACH
SPV.0060.237	Temporary EVP System IH 94 WB Ramps & STH 318	EACH
SPV.0060.238	Temporary EVP System IH 94 EB Ramps & CTH T	EACH
SPV.0060.239	Temporary EVP System IH 94 WB Ramps & CTH T	EACH

Payment is full compensation for furnishing and installing all required equipment, materials, and supplies; for maintaining and changing the EVP detectors to match the plans, traffic control, and construction staging; for relocating the temporary EVP detectors due to construction activities, if required; for testing the EVP system for each stage and sub-stage of construction; for periodically cleaning all temporary EVP detectors; for removing the temporary EVP system; and for cleaning up and properly disposing of waste.

- 109. Remove and Reinstall Fiber Optic Pigtail STH 318 & Silvernail Road, Item SPV.0060.250; Remove and Reinstall Fiber Optic Pigtail IH 94 EB Ramps & STH 318, Item SPV.0060.251; Remove and Reinstall Fiber Optic Pigtail IH 94 WB Ramps & STH 318, Item SPV.0060.252; Remove and Reinstall Fiber Optic Pigtail IH 94 EB Ramps & CTH T, Item SPV.0060.253; Remove and Reinstall Fiber Optic Pigtail IH 94 WB Ramps & CTH T, Item SPV.0060.254.**

**A Description**

This special provision describes removing and reinstalling existing fiber optic cable in the traffic signal cabinets.

**B (Vacant)**

**C Construction**

Disconnect the existing fiber optic pigtail from the existing termination panel in the traffic signal cabinet. Pull the existing fiber optic pigtail back to the nearest pull box or communications vault to store during construction. After installation of the proposed traffic signal cabinet, pull the fiber optic pigtail back into the proposed traffic signal cabinet.

**D Measurement**

The department will measure Remove and Reinstall Fiber Optic Pigtail [Location] as each individual unit of work for each intersection, acceptably completed.

**E Payment**

The department will pay for measured quantities at the contract unit price under the following bid item:

ITEM NUMBER	DESCRIPTION	UNIT
SPV.0060.250	Remove and Reinstall Fiber Optic Pigtail STH 318 & Silvernail Road	EACH
SPV.0060.251	Remove and Reinstall Fiber Optic Pigtail IH 94 EB Ramps & STH 318	EACH
SPV.0060.252	Remove and Reinstall Fiber Optic Pigtail IH 94 WB Ramps & STH 318	EACH
SPV.0060.253	Remove and Reinstall Fiber Optic Pigtail IH 94 EB Ramps & CTH T	EACH
SPV.0060.254	Remove and Reinstall Fiber Optic Pigtail IH 94 WB Ramps & CTH T	EACH

Payment is full compensation for disconnecting the existing fiber optic terminations and pulling existing fiber optic cable. The department will pay separately for the proposed fiber optic terminations.

**110. Relocate Existing Pull Box, Item SPV.0060.255.**

**A Description**

This special provision describes relocating an existing pull box with active cables, while maintaining continuous operation of existing cables.

**B Materials**

Furnish materials conforming to the requirements of standard spec 652 and 653.

**C Construction**

Excavate a trench around the existing fiber optic conduit from the pull box's existing location to proposed location. Slide the pull box along the conduit to the proposed location. Cut the conduit entering the pull box and slide it to the opposite side. Alternatively, remove the existing conduit, relocate the pull box while protecting the active cables, move the pull box, and install split duct conduit around the active cables between the pull box and remainder of the existing conduit. Couple the existing and relocated conduit together. All work shall be completed per standard spec 652 and 653.

The existing fiber optic cable shall remain functional throughout this pull box relocation process. Any existing wire slack within the existing pull box may be pulled to the nearest adjacent pull box, and then pulled back to the relocated pull box after completion.

**D Measurement**

The department will measure Relocate Existing Pull Box as each individual unit of work for each pull box, acceptably completed.

**E Payment**

The department will pay for measured quantities at the contract unit price under the following bid item:

ITEM NUMBER	DESCRIPTION	UNIT
SPV.0060.255	Relocate Existing Pull Box	EACH

Payment for Relocate Existing Pull Box is full compensation for pull wires or ropes and pulling existing cable; for moving and resetting pull box; for cutting, removing, moving, coupling, furnishing and installing conduit; for excavating, bedding, and backfilling, including any sand, concrete, or other required materials; and for making inspections. The department will pay separately for furnishing and placing topsoil, fertilizer, seed, and mulch in disturbed areas under the contract items for finishing items.

**111. Remove Pole, Item SPV.0060.300.**

**A Description**

This special provision describes removing an existing Type 2, 3, 4, 5, 6, or 7 pole.

**B Materials**

Existing poles, including antennae, conduit and cabling, and any other equipment mounted to the poles.

**C Construction**

Disconnect all cables and wiring that are mounted on or in the poles, and carefully remove the pole from the concrete footing. Salvage and store all hardware for pick up by the department. Dispose of the pole and any conduit and cabling appropriately away from the project area.

**D Measurement**

The department will measure Remove Pole as a unit, removed from the concrete base, salvaged and stored, including attached hardware, according to the contract.

**E Payment**

The department will pay for measured quantities at the contract unit price under the following bid item:

ITEM NUMBER	DESCRIPTION	UNIT
SPV.0060.300	Remove Pole	EACH

Payment is full compensation for disconnecting any necessary wiring; removing the poles and equipment mounted on the poles; storing the poles and any equipment attached to them; and for furnishing all labor, tools, equipment, transportation, and any other incidentals necessary to complete the contract work.

**112. Ground Rod, Item SPV.0060.301.**

**A Description**

This special provision describes installing a ground rod and ground wire.

**B Materials**

Ground rod shall be copper clad steel with cladding 13 mils thick. The minimum diameter is 5/8-inch and the minimum length is eight feet. Ground wire shall be AWG # 6 bare, solid copper.

**C Construction**

Use exothermic welding to connect the ground wire to the rod. Install the rod vertically, or as close to vertical as conditions permit. Select locations with moist soil, if available. Place the rod at least six feet from all other ground rods.

**D Measurement**

The department will measure Ground Rod by the unit, acceptably installed.

**E Payment**

The department will pay for measured quantities at the contract unit price under the following bid item:

ITEM NUMBER	DESCRIPTION	UNIT
SPV.0060.301	Ground Rod	EACH

Payment is full compensation for installation of the ground rod and ground wire; welding and connections at both ends of the ground wire.

**113. Refocus Vehicle Detector Assembly, Item SPV.0060.302.**

**A Description**

This special provision describes refocusing an existing microwave detector, or detectors, on a pole or other structure, for operation with a new lane configuration.

**B Materials**

Materials include Electronic Integrated Systems, Inc. (EIS) Remote Traffic Microwave Sensors (RTMS) and the respective poles they have been mounted on.

**C Construction**

Coordinate all planned down-time of vehicle detector assemblies with the STOC at (414) 227-2166. Notify the STOC an amount of time ahead of planned down-time equal to the planned down-time. Examples would be that a 4-hour temporary down-time of the system would require notification 4-hours ahead of time while an 8-hour planned down-time would require 8-hours of advance notification.

Refocus and recalibrate the detector each time the adjacent traffic pattern is changed due to a change in traffic control or construction staging.

Verify to the satisfaction of the engineer that the existing detector assembly is working properly. Inspect the vehicle detector assembly for damage.

**D Measurement**

The department will measure Refocus Vehicle Detector Assembly by the unit, acceptably refocused and operational.

**E Payment**

The department will pay for measured quantities at the contract unit price under the following bid item:

ITEM NUMBER	DESCRIPTION	UNIT
SPV.0060.302	Refocus Vehicle Detector Assembly	EACH

Payment is full compensation for making the detector fully operational with a new lane configuration.

**114. Removing Controller Cabinet Base, Item SPV.0060.303.**

**A Description**

This special provision describes removing an existing controller cabinet concrete base.

**B Materials**

Existing controller cabinet base, including concrete masonry, ground rods, masonry anchors, and restoration materials such as topsoil, seeding, mulch, and fertilizer according to the pertinent provisions of standard spec 201, 625, 627, 629, 630, 636, and 640.

**C Construction**

Remove and dispose of the concrete foundation and all other pertinent materials and restore the disturbed area by placing 4-inches of topsoil, and fertilize, seed, and mulch all disturbed areas according to the pertinent requirements of the standard specifications.

**D Measurement**

The department will measure Removing Controller Cabinet Base by the unit, removed from the ground, removed from the project site, and the disturbed area restored according to the contract.

**E Payment**

The department will pay for measured quantities at the contract unit price under the following item:

ITEM NUMBER	DESCRIPTION	UNIT
SPV.0060.303	Removing Controller Cabinet Base	EACH

Payment is full compensation for removing and disposing of a concrete controller cabinet base, including masonry anchors, ground rods, and concrete masonry; and for topsoil, fertilizer, seed and mulch.

**115. Removing Controller Cabinet, Item SPV.0060.304.**

**A Description**

This special provision describes removing an existing controller cabinet.

**B (Vacant)**

**C Construction**

Remove controller cabinets at the locations shown on the plans, or as directed by the engineer. Salvage and store the cabinets and all contents for pick up by the department.

Do not remove the existing ITS control cabinets, or any other associated equipment until necessary, or as directed by the engineer. Carefully remove the existing cabinets from the concrete bases, together with all components in such a manner as to safeguard all parts and wiring from damage or loss. Salvage and store the cabinet and contents for pick up by the department.

Prior to removing the existing ITS control cabinets, remove all cables being terminated in the cabinet. Cut existing cables flush with cabinet base and cap existing conduits. Dispose of the cables properly away from the project area.

**D Measurement**

The department will measure Removing Controller Cabinet by the unit, acceptably removed, salvaged, and stored.

**E Payment**

The department will pay for measured quantities at the contract unit price under the following item:

ITEM NUMBER	DESCRIPTION	UNIT
SPV.0060.304	Removing Controller Cabinet	EACH

Payment is full compensation for removal and storage of the controller cabinet; disconnecting all associated wires and cables; for capping existing conduits, and for furnishing all labor, tools, equipment, transportation, and incidentals necessary to complete the work.

**116. Modify Lighting Control Cabinets 120/240, Item SPV.0060.401.**

**A Description**

This special provision describes modify lighting control cabinets 120/240 by furnishing and installing 30amp-2P disconnect and surge protection system into the existing cabinet. The work includes installation of wires, disconnect switch, fuses, surge protection system grounding and hardware necessary to make additional disconnect and surge protection system fully operational and ready to connect branch circuits.

**B Materials**

The 30amp 2-pole disconnect shall be Square D model matching existing disconnect in the cabinet or approved equal with 30amp fuses.

Surge Protection Devices shall meet the material requirements for 240/480V system.

Furnish wires according to the pertinent requirements of standard spec 655.2.6.

Minimum wire size shall be No. 12 AWG copper.

**C Construction**

No removal work will be permitted without approval from the engineer. Removed luminaires and lamps become the property of the contractor.

Train the cables in straight horizontal and vertical directions, and parallel next to and adjacent to other cables whenever possible. Install wiring in slotted wire way between terminal strip, contactor and panel board. Secure all remaining wiring using screw attachment type straps; adhesive type will not be allowed.

Surge arresters shall be installed to allow LED indicator(s) to be readily visible when viewing inside of cabinet. Connect the surge arresters per manufacturer's recommendations.

Make all connections from the underground field wiring to equipment in the lighting control cabinet through distribution blocks.

The contractor shall measure the existing ground resistance to earth; if the value is more than 10 ohms; additional rods shall be added to the grounding electrode. A maximum number of three rods shall be coupled together. If coupling three rods together does not lower the resistance to 10 ohms, then additional grounding electrodes shall be installed, a minimum of 6 feet from each other and the initial installation and connected by a grounding electrode conductor to form a ground field. Ground rod access well shall be provided per NEC code.

**D Measurement**

The department will measure Modify Lighting Control Cabinets 120/240 by the unit modified, acceptably completed.

**E Payment**

The department will pay for measured quantities at the contract unit price under the following bid item:

ITEM NUMBER	DESCRIPTION	UNIT
SPV.0060.401	Modify Lighting Control Cabinets 120/240	EACH

Payment will be full compensation for modifying existing lighting controller 120/240; for installing disconnect; for installing surge protection system; for grounding; and for wires.

**117. Maintenance of Lighting Systems (1060-47-70), Item SPV.0060.402.**

**A Description**

This special provision describes maintaining existing and proposed lighting system that includes airport obstruction lights on top of the light poles beginning on the date that the contractor's activities, including electrical, begin at the job site. Properly operate and maintain all existing and proposed lighting systems which are part of, or which may be affected by, the work until final acceptance or as otherwise determined by the engineer.



Before performing any excavation, removal, or installation work, including electrical, for the project, initiate a request for maintenance transfer and preconstruction inspection, as specified in this special provision. Conduct the transfer and inspection in the engineer's presence and a representative of the party or parties responsible for maintenance of any lighting systems which may be affected by the work. Request the maintenance preconstruction inspection at least seven calendar days before the desired inspection date.

Existing lighting systems, when shown on the plans, are intended only to indicate the general equipment installation of the systems involved, possibly not exactly representing the field conditions. A site visit will confirm the exact condition of the electrical equipment and systems to be maintained.

Issues found during contractor assessment can be discussed and addressed by contacting the SE Region Lighting Engineer (Eric Perea) before transferring maintenance responsibility to the contractor.

Maintenance of the lighting system includes lighting control cabinet(s): HL-67-TC and HL-67-MD.

The following lighting control cabinet(s) will be used long enough to allow the installation of temporary and or final lighting: HL-67-TC and HL-67-MD.

## **B (Vacant)**

## **C Construction**

### **C.1 Existing Lighting Systems**

Existing lighting systems are defined as any lighting system or part of a lighting system in service before this contract. The contract drawings indicate the general extent of any existing lighting. [Understand](#) the effort required for compliance with these specifications; clear and replace any knockdowns or damage caused to the existing lighting system, regardless of who causes the damage. Maintain existing lighting system as follows:

**Partial Maintenance:** Only maintain the affected circuits if the number of circuits affected by the contract is equal to or less than 40% of the total number of circuits in a given controller and the controller is not part of the contract work unless otherwise indicated. Obtain engineer approval to isolate the affected circuits by in-line waterproof fuse holders as specified elsewhere.

**Full Maintenance:** Maintain the entire controller and all associated circuits if the number of circuits affected by the contract is greater than 40% of the total number of circuits in a given controller, or if the controller is modified in any way under the contract work.

### **C.2 Proposed Lighting Systems**

Proposed lighting systems are any temporary or final lighting systems or part of a lighting system to be constructed under this contract.

Maintain all items installed under this contract, including all equipment failures or malfunctions as well as equipment damage by the motoring public, contractor operations, or other sources.

### **C.3 Maintenance Operations**

Maintain lighting units (including sign lighting and airport obstruction lights), cable runs, and lighting controls. If a pole is knocked down or sign light damage is caused by normal vehicular traffic, promptly clear the lighting unit and circuit discontinuity, and restore the system to service. Reinstall the lighting unit (if salvageable), or install a new one.

Provide weekly night-time patrol of the lighting system, with patrol reports filed on standard forms as designated by the engineer. Send a copy to the region lighting coordinator.

Correct the deficiencies within a time frame acceptable to the engineer. Remaining deficiencies may require corrective action on specific lighting system equipment as described in the chart or based on material availability.

Incident or Problem	Service Response Time	Service Restoration Time	Permanent Repair Time
Control cabinet out	12 hours	24 hours	7 Calendar days
Hanging mast arm	<b>Emergency</b> - As Soon As Possible	na	7 Calendar days
Motorist caused damage or leaning light pole 10 degrees or more	<b>Emergency</b> - As Soon As Possible	7 Calendar days	14 Calendar days
Circuit out – Needs to reset breaker	12 hours	12 hours	na
Circuit out – Cable trouble	12 hours	7 Calendar days	21 Calendar days
Outage of 3 or more successive lights	12 hours	7 Calendar days	na
Outage of 75% of lights on one tower	12 hours	7 Calendar days	na
Outage of light nearest RR crossing approach, Islands and gores	12 hours	7 Calendar days	na
Outage (single or multiple non successive lights) found on night outage survey	na	na	7 Calendar days

#### C.4 Lighting

1. **Serve Response Time:** The amount of time from the initial contractor notification to the patrolman physically arriving.
2. **Service Restoration Time:** The amount of time from the initial contractor notification to a fully operational system again. (In cases of motorist-caused damage, the undamaged portions of the system are operational.)
3. **Permanent Repair Time:** The amount of time from initial contractor notification until permanent repairs are made unless the contractor was required to make temporary repairs to meet the service restoration requirement. Temporary repairs that do not meet the service restoration requirements require engineer's approval.

#### C.5 Operation of Lighting

Maintain operational lighting every night, from dusk until dawn and airport obstruction lights 24/7. Do not operate duplicate lighting systems (such as temporary lighting and proposed new lighting) simultaneously. Do not keep lighting systems in operation during long daytime periods, except only airport obstruction lights. Ensure that the lighting system that includes airport obstruction lights is fully operational and approved by the engineer before submitting a pay request.

#### D Measurement

The department will measure Maintenance of Lighting Systems (1060-47-70) as each individual unit of work, acceptably completed.

#### E Payment

The department will pay for measured quantities at the contract unit price under the following bid item:

ITEM NUMBER	DESCRIPTION	UNIT
SPV.0060.402	Maintenance of Lighting Systems (1060-47-70)	EACH

Payment is full compensation for Maintenance of Lighting Systems, both existing and proposed, weekly night-time patrol of the lighting system, mobilization, and filed patrol reports.

The contractor will be reimbursed for replaced equipment, materials only, if the invoice paid for the individual piece of equipment is greater than \$500.

Non-compliance with designated response, restoration, and permanent repair times will result in liquidated damages of \$500 per day per occurrence. In addition, the department reserves the right to assign any work not completed within this timeframe to the State Electrical Engineering and Electronics Unit. Reimburse all costs associated to repair this uncompleted work within one month after the incident or additional liquidated damages of \$500 per month per occurrence will be assessed. Unpaid bills will be deducted from the cost of the contract. Repeated non-response or a negligent maintenance shall result in

the State's Electrical Engineering and Electronics Unit being directed to correct all deficiencies and the resulting costs deducted from all monies owed the contractor.

Not understanding the effort required for compliance with these specifications will not be justification for extra payment or reduced responsibilities. No payment will be considered for damage or repairs due to contractor operations.

Not ensuring that the lighting system is fully operational and approved by the engineer before submitting a pay request will be grounds for denying the pay request.

## **118. Lighting System Integrator (1060-47-70), Item SPV.0060.403.**

### **A Description**

These special provisions describe coordinating lighting with various parties; record keeping, and documentation. Where the department is responsible for freeway lighting operation, maintenance, or utility locates on existing systems or systems overlapping project boundaries, the contractor's freeway lighting integrator will serve as the contractor's liaison to the department's electrical operations unit.

### **B Personnel Qualifications**

Assign personnel experienced in underground utility construction and department lighting specifications and practices.

### **C Construction**

At any one time during the project, the contractor shall assign one individual person as the freeway lighting integrator.

The freeway lighting integrator shall:

1. Familiarize himself with the location and nature of existing lighting circuits. This familiarity shall include the extent of any lighting system that overlaps project limits.
2. Maintain a file of applicable permits or licenses issued to the contractor and convey copies to the engineer.
3. Keep with him at all times a contact list of affected lighting personnel.
4. Maintain a record of tagouts and the clearance of tagouts.
5. Interface with department electrical personnel to determine how contract limits might affect maintenance or operation of existing systems.
6. Maintain ongoing contact with the department's Diggers' Hotline Coordinator to ensure that each of the two persons knows that all requested utility locates are marked in the field by the appropriate party. The intent here is to assure coordination. This special provision does not transfer additional utility locating responsibilities to the contractor, beyond those responsibilities already assigned to him by other provisions of the contract.
7. Inform the department of any lighting outages, including outside the project limits where a lighting system crosses the project boundary.
8. Maintain in any format real-time records of existing, removed, and new lighting facilities. Include utility service extensions. Additional required records will include temporary connections and their ultimate removal.
9. Maintain records of tests, including: "meg" tests, amperage draw per circuit leg, voltage reading at the disconnect, and voltage reading at the furthest pole per circuit leg. Convey these records at time of acceptance or partial acceptance.
10. At the time of acceptance or partial acceptance, convey as-built drawings in both the following formats: plan redlines and .dgn electronic. Include utility service extensions.
11. Secure copies of operator's manuals, tear sheets, etc. as may be provided by manufacturers of some lighting materials and convey a minimum of three sets to the department.
12. Work with the engineer to notify department electrical personnel of acceptance or partial acceptance.
13. Perform related duties as may be needed to ensure continuity of freeway lighting during construction, and orderly transfer upon completion.

**D Measurement**

The department will measure Lighting System Integrator (1060-47-70) by each individual unit, acceptably completed.

**E Payment**

The department will pay for measured quantities at the contract unit price under the following bid item:

ITEM NUMBER	DESCRIPTION	UNIT
SPV.0060.403	Lighting System Integrator (1060-47-70)	EACH

Payment will be full compensation for providing specified expertise, assistance and documents, and personnel costs.

**119. Lighting System Survey (1060-47-70), Item SPV.0060.404.**

**A Description**

These special provisions describe performing lighting system survey using Global Position System (GPS).

**B (Vacant)**

**C Construction**

Locate and survey using GPS all the lighting units and control cabinets. Maintain neat, orderly, and complete survey notes. Enter the coordinates into a Microsoft Excel 2007 spreadsheet along with other required fields as specified by Wisconsin Department of Transportation (WisDOT).

**D Measurement**

The department will measure Lighting System Survey (1060-47-70) by each individual unit, acceptably completed.

**E Payment**

The department will pay for measured quantities at the contract unit price under the following bid item:

ITEM NUMBER	DESCRIPTION	UNIT
SPV.0060.404	Lighting System Survey (1060-47-70)	EACH

Payment will be full compensation for locating and surveying all the lighting units and control cabinets and for furnishing all labor, tools, materials, equipment, and incidentals necessary to complete the contract work.

**120. Concrete Barrier 51-Inch Special, Item SPV.0090.001.**

**A Description**

This special provision describes concrete barrier wall 51-inch double faced replacement. Remove and replace the concrete barrier wall according to the construction details, plan details and as hereinafter provided.

**B Materials**

Furnish all materials according to standard spec 603.2.

**C Construction**

**C.1 Permanent Barrier General**

Construct permanent barrier of the type the bid item indicates.

Excavate for barrier footings as the plans show. Where new barrier penetrates existing pavement, saw out the pavement full depth in the required excavation area. Backfill, dispose of excess material, and restore the grade after placing footings.

Cast permanent barrier and transitions in place. Use construction methods conforming to standard spec 502 and conform to the hot weather placement requirements of standard spec 501.3.8.2. Use forms or engineer-approved slip form methods for barrier. Use forms for transitions. Construct barrier on horizontal curves as a series of 12-foot or shorter chords.

Install delineators at the spacing the plans show.

## C.2 Anchor Dowels

Anchor dowels are not required if the base and barrier are cast in one pour. If casting separately, cast anchor dowels in the supporting surface, or secure them in drilled holes with adhesive. Clean drilled holes and install dowels according to the adhesive manufacturer's recommendations. Ensure installed dowels develop the strength the plans show.

## C.3 Joints

Place 3/4-inch expansion joints in the barrier and footing matching existing pavement expansion joints and at plan locations. Use filler material sized to conform to the cross-section of the barrier and footing.

## C.4 Curing

Cure permanent concrete barrier as specified in standard spec 415.3.12.2. Use PAM as required in standard spec 415.3.12.1.

## C.5 Straightedging

While the concrete is still plastic, test the wall surfaces, except vertical surfaces on horizontal curves, for trueness with a 10-foot straightedge. Test the total surface area of the barrier top and face by holding the straightedge in successive positions parallel to the length of the barrier. Straightedge the barrier in successive stages of not more than 1/2 the length of the straightedge.

Immediately, fill any depressions or projections that deviate more than 3/8 inch in 10 feet with freshly mixed concrete or strike-off and refinish the surface.

## C.6 Surface Finish

Broom finish exposed slip-formed surfaces. Except for footings, provide a sack rubbed finish on exposed formed surfaces as specified in standard spec 502.3.7.5.

## C.7 Surface Smoothness Tolerance

After the barrier hardens, test the top and upper front face for smoothness with a 10-foot straightedge. Do not straightedge the front face across chord boundaries on horizontal curves. The engineer will accept areas that show high spots or depressions greater than 3/8 inch but not greater than 3/4 inch in 10 feet. The contractor may grind high spots to less than 3/4 inch in 10 feet tolerance. Remove and replace areas that have high spots or depressions in excess of 3/4 inch in 10 feet on the barrier top or face surfaces.

The engineer will evaluate vertical surfaces on horizontal curves to ensure that they are perpendicular to the pavement surface.

## D Measurement

The department will measure Concrete Barrier 51-Inch Special in length by the linear foot, acceptably completed, measured along the base of the barrier.

## E Payment

The department will pay for measured quantities at the contract unit price under the following bid item:

ITEM NUMBER	DESCRIPTION	UNIT
SPV.0090.001	Concrete Barrier 51-Inch Special	LF

Payment for the permanent barrier bid items is full compensation for providing barrier or the specified transition; for excavating and backfilling for all types except roadside retaining wall; and for restoring the grade.

The department will pay for permanent barrier deficient in smoothness by more than 3/8 inch but not greater than 3/4 inch, or ground to less than 3/4 inch, at 75 percent of the contract unit price. The department will administer the price adjustment under the Nonconforming Smoothness Concrete Barrier administrative item.

The department will pay separately for associated work as follows: - Sawing existing concrete or asphalt not placed under the contract, under the Sawing Concrete or Sawing Asphalt bid item as specified in standard spec 690.5. - Excavating and backfilling required for roadside retaining wall barrier, Concrete Barrier Type S(size)C bid items, under the Excavation bid items as specified in standard spec 205.5 and under the Backfill Structure bid items as specified in 210.5. - Providing delineators for permanent barrier, under the Delineator Brackets and Delineator Reflectors bid items as specified in standard spec 633.5.

**121. Marking Epoxy 4-Inch Black Non Grooved, Item SPV.0090.002;  
Marking Epoxy 6-Inch Black Non Grooved, Item SPV.0090.003;  
Marking Epoxy 8-Inch Black Non Grooved, Item SPV.0090.004;  
Marking Epoxy 10-Inch Black Non Grooved, Item SPV.0090.005.**

**A Description**

This special provision describes applying epoxy black marking conforming to standard spec 646, as the plans show, and as follows.

**B Materials**

Furnish 4-inch, 6-inch, 8-inch, or 10-inch black epoxy pavement marking materials conforming to standard spec 646.

**C Construction**

Apply 4-inch, 6-inch, 8-inch, or 10-inch black epoxy conforming to standard spec 646.3.

**D Measurement**

The department will measure Marking Epoxy 4-inch, 6-inch, 8-inch, and 10-inch Black Non Grooved by the linear foot, acceptably completed, measured once as the length of the centerline of the completed installation.

**E Payment**

The department will pay for measured quantities at the contract unit price under the following bid items:

ITEM NUMBER	DESCRIPTION	UNIT
SPV.0090.002	Marking Epoxy 4-inch Black Non Grooved	LF
SPV.0090.003	Marking Epoxy 6-inch Black Non Grooved	LF
SPV.0090.004	Marking Epoxy 8-inch Black Non Grooved	LF
SPV.0090.005	Marking Epoxy 10-inch Black Non Grooved	LF

Payment is full compensation for providing replacement marking.

**122. Concrete Barrier Wall Epoxy Crack Sealing, Item SPV.0090.006.**

**A Description**

This special provision describes concrete barrier wall crack sealing repairs. Seal vertical cracks in the concrete barrier wall according to the plan details and as hereinafter provided.

**B Materials**

Furnish a penetrating epoxy sealant manufactured by Sika, Adhesive Engineering, Technical Sealants, Dayton Superior, or equal. Before using, obtain the engineer's approval for the epoxy system which is proposed to seal the cracks.

**C Construction**

Before sealing, clean the cracks by chipping and by using high-pressure air.

After all the cleaning is completed, inject epoxy sealant into the cracks to be sealed. Seal the cracks using the penetrating epoxy sealant as recommended by the sealant manufacturer.

**D Measurement**

The department will measure Concrete Barrier Wall Epoxy Crack Sealing by the linear foot, acceptably completed.

**E Payment**

The department will pay for measured quantities at the contract unit price under the following bid item:

ITEM NUMBER	DESCRIPTION	UNIT
SPV.0090.006	Concrete Barrier Wall Epoxy Crack Sealing	LF

Payment for Concrete Barrier Wall Epoxy Crack Sealing is full compensation for cleaning the cracks; for furnishing and placing the epoxy sealant, curing, and protecting all materials.

**123. Outdoor Rated Network Cable, Item SPV.0090.300.**

**A Description**

This special provision describes furnishing and installing outdoor rated network cable in new conduit, as paid for with other items in this contract, or existing conduit, as shown on the plans or as directed by the engineer.

**B Materials**

Furnish outdoor rated Category 5e, or better, UTP cable with water-blocking flooded core and UV-resistant polyethylene jacket. Cable shall consist of 4-pairs of 24 AWG solid copper conductors and shall meet the requirements of ANSI/TIA/EIA 5 68A Category 5e, CENELEC EN50173, ICEA S-90-661, and ISO/IEC 11801.

Furnish an RJ45 connector for each end of the cable.

**C Construction**

Install the cable following the manufacturer's installation guidelines.

Install the RJ45 connectors (if not done prior to installation) according to manufacturer's installation guidelines.

Use a purpose built "Pass-Fail" network cable tester to test the network cable installation for Category 5, Class E compliance. Repair any connections or cable as needed for the test to register a "Pass".

Connect the cable to the devices on each end as shown on the plans or as directed by the engineer.

**D Measurement**

The department will measure Outdoor Rated Network Cable, acceptably installed and tested, by the linear foot.

**E Payment**

The department will pay for measured quantities at the contract unit price under the following bid item:

ITEM NUMBER	DESCRIPTION	UNIT
SPV.0090.300	Outdoor Rated Network Cable	LF

Payment is full compensation for furnishing, installing, and testing the outdoor rated network cable; for connecting the cable to the devices at each end of the cable; and for all labor, transportation, and incidentals necessary to complete the work.

**124. Cable Aerial Aluminum 6 AWG Triplex, Item SPV.0090.401.**

**A Description**

Furnish, install, and connect temporary overhead cable complete with all splicing, identifications, terminations and guy wires at wood poles. The removal of the overhead cable after the temporary lighting is approved for removal.

**B Materials**

Overhead cable shall be aluminum conductors according to ASTM B 230 and shall be Class B stranded according to ASTM B 231, and shall conform to the values listed in the table below:

Phase Conductor			Messenger Wire		
Size AWG	Stranding	Avg. Insulation Thickness	Min. Size AWG	Stranding	
		mm	mils		
6	7	1.1	45	6	6/1
4	7	1.1	45	4	6/1
2	7	1.1	45	2	6/1
1/0	7	1.1	45	1/0	6/1

The aerial cable shall be an assembly of insulated aluminum conductors and a steel messenger wire according to ANSI/ICEA S-76-474. The cable assembly may have the messenger wire intertwined with the insulated cables or lashed to the insulated cables by a factory wrap. The cable shall be assembled according to ANSI/ICEA S-76-474.

All cable shall be rated 600-V. The cable shall be rated 105° C dry and 90° C wet and shall be suitable for installation in wet and dry locations, and shall be resistant to oils and chemicals, and UV rated. The UL listing mark, cable voltage, insulation type and ratings, as well as the cable size, shall all be clearly printed on the cable in a color contrasting with the insulation color. When specified, each cable installed shall be identified with its complete circuit number at each termination, splice, junction box or other location where the wire is accessible.

All electric cables installed shall be color coded. Neutral wires shall be color-coded white. Single phase three wire runs of cable shall be color-coded one black, one red, and one white. Insulated ground wires, where applicable, shall be green. Color striping of cables will not be acceptable in lieu of the specified color coding means.

Make the luminaire connections to the aerial cable with listed parallel tap insulation piercing connectors. The connector shall be rated for 600-V and be listed under UL Standard 486B.

### **C Construction**

Overhead cable as shown on temporary lighting plans will not be needed for final lighting. Remove temporary overhead cable. Removal of temporary overhead cable will be incidental to this pay item and it will become property of the contractor. The bid price shall reflect the salvage value of the temporary overhead cable.

Upon written request by the contractor, the engineer may permit to reuse removed temporary overhead cable of ampacity equivalent to the specified cable and of a type and condition approved by the engineer, if possible.

Install guy wires as necessary per WisDOT standard details for Spanwire Temporary Traffic Signal.

Conform to standard spec 655.3.5(9) for ground resistance testing.

### **D Measurement**

The department will measure Cable Aerial Aluminum 6 AWG Triplex in length by the linear foot in place, acceptably completed, and will be taken as the length of the messenger wire. Measurement will be made in a straight line between changes in direction and to the centers of light standards and control cabinets. Sag of the aerial cable or vertical cable will not be measured for payment. The rewiring to facilitate relocation of the cable due to staging or other construction requirements will not be measured for payment.

### **E Payment**

The department will pay for measured quantities at the contract unit price under the following bid item:

ITEM NUMBER	DESCRIPTION	UNIT
SPV.0090.401	Cable Aerial Aluminum 6 AWG Triplex	LF

Payment is full compensation for providing electrical wire; for making all connections; for providing all connectors, including wire nuts, fuses, fuse holders, splices, tape, and insulators; for providing messenger wire, and guy wires; and for removing temporary overhead cable.

## **125. Repair Galvanized Coating, Item SPV.0165.001.**

### **A Description**

This special provision describes providing surface cleaning and painting the galvanized surfaces at locations specified in the plans, and as hereinafter provided.

### **B Materials**

Supply specific product data sheets to the engineer prior to starting work. Material is to be approved by the engineer prior to being installed.



## C Construction

Repair all zinc coating that is chipped or damaged or as otherwise noted by plans or the engineer by metallizing according to ASTM A780. Thoroughly clean the places receiving coating before applying the new coating.

## D Measurement

The department will measure Repair Galvanized Coating by the square foot, acceptably completed, with a minimum quantity of one (1) square foot at each repair location.

## E Payment

The department will pay for measured quantities at the contract unit price under the following bid item:

ITEM NUMBER	DESCRIPTION	UNIT
SPV.0165.001	Repair Galvanized Coating	SF

Payment is full compensation for cleaning; for protecting traffic and property; for furnishing all materials and miscellaneous items to complete the replacement; for handling, transporting, and erecting.

## 126. Wall Modular Block Mechanically Stabilized Earth R-67-159, Item SPV.0165.002.

### A Description

This special provision describes designing, furnishing materials, and erecting a permanent earth retention system according to the lines, dimension, elevations, and details as shown on the plans and provided in the contract. The design life of the wall and all wall components shall be 75 years minimum.

This special provision describes the quality management program (QMP) for Mechanically Stabilized Earth (MSE) walls. A quality management program is defined as all activities, including process control, inspection, sampling and testing, and necessary adjustments in the process that are related to the construction of the MSE wall, which meets all the requirements of this provision.

This special provision describes contractor quality control (QC) sampling and testing for backfill density testing, documenting those results, and documenting related production and placement process changes. This special provision also describes department quality verification (QV), independent assurance (IA), and dispute resolution.

Chapter 8 of the department's construction and materials manual (CMM) provides additional detailed guidance for QMP work and describes sampling and testing procedures.

### B Materials

#### B.1 Proprietary Wall Systems

The supplied wall system must be from the department's approved list of Modular Block Mechanically Stabilized Earth Wall systems. Proprietary wall systems must conform to the requirements of this specification and be pre-approved for use by the department's Bureau of Structures. The department maintains a list of pre-approved proprietary wall systems. See the approved products list titled "Proprietary Retaining Wall System Vendors." The name of the pre-approved proprietary wall system selected shall be furnished to the engineer within 25 days after the award of contract. The department also maintains a separate list of plants pre-approved by the department to provide wall facing units. See the approved products list titled "Precast Concrete and Block Fabricators." The identity of the plant manufacturing the facing units shall be furnished to the engineer at least 14 days prior to the project delivery.

To be eligible for use on this project, a system must have been pre-approved by the Bureau of Structures and added to that list prior to the bid closing date. To receive pre-approval, the retaining wall system must comply with all pertinent requirements of this provision and be prepared according to the requirements of Chapter 14 of the department's LRFD Bridge Manual. Information and assistance with the pre-approval process can be obtained by contacting the Bureau of Structures, Structures Maintenance Section at the following email address: [DOTDLStructuresFabrication@dot.wi.gov](mailto:DOTDLStructuresFabrication@dot.wi.gov).

To be eligible to provide wall facing units for this project, a block manufacturing plant must be pre-approved by the Bureau of Technical Services and added to that list prior to the bid closing date. Information and assistance with the pre-approval process can be obtained by contacting the Bureau of Technical Services at the following email address: [DOTProductSubmittal@wisconsin.gov](mailto:DOTProductSubmittal@wisconsin.gov).

## B.2 Design Requirements

It is the responsibility of the contractor to submit a design and supporting documentation as required by this special provision, for review and acceptance by the department, to show the proposed wall design conforms to the design specifications. The submittal shall include the following items for review: detailed plans and shop drawings, complete design calculations, explanatory notes, supporting materials, and specifications. The detailed plans and shop drawings shall include all details, dimensions, quantities, and cross-sections necessary to construct the walls. Submit shop drawings to the engineer conforming to [105.2](#) with electronic submittal to the fabrication library under [105.2.2](#). Certify that shop drawings conform to quality control standards by submitting department form [DT2329](#) with each set of shop drawings. Department review does not relieve the contractor from responsibility for errors or omissions on shop drawings. Submit no later than 60 days from the date of notification to proceed with the project and a minimum of 30 days prior to the date proposed to begin wall construction.

The plans and shop drawings shall be prepared on reproducible sheets 11 inch x 17 inch, including borders. Each sheet shall have a title block in the lower right corner. The title block shall include the WisDOT project identification number and structure number. Design calculations and notes shall be on 8 ½ inch x 11 inch sheets, and shall contain the project identification number, name or designation of the wall, date of preparation, initials of designer and checker, and page number at the top of the page. All plans, shop drawings, and calculations shall be signed, sealed, and dated by a professional engineer licensed in the State of Wisconsin.

The design of the wall shall be in compliance with the current American Association of State Highway and Transportation Officials LRFD (AASHTO LRFD) Bridge Design Specifications with latest interim specifications for Mechanically Stabilized Earth Walls, WisDOT's current Standard Specifications for Highway and Structure Construction (standard spec), Chapter 14 of the WisDOT LRFD Bridge Manual and standard engineering design procedures as determined by the department. Loads, load combinations, load and resistance factors shall be as specified in AASHTO LRFD Section 11. The associated resistance factors shall be defined according to Table 11.5.7-1 in AASHTO LRFD.

Design and construct the walls according to the lines, grades, heights, and dimensions shown on the plans, as herein specified, and as directed by the engineer.

Walls parallel to supporting highway traffic shall be designed for the effects of highway surcharge loading equivalent of 2 feet soil surcharge weight or 240 psf. The design shall also consider the traffic barrier impact where applicable. Walls that do not carry highway traffic shall be designed for a live load surcharge of 100 psf according to Chapter 14 of the WisDOT LRFD Bridge Manual or as stated on the plans.

A maximum value of the angle of internal friction of the wall backfill material used for design shall be assumed to be 30 degrees without a certified report of tests. If a certified report of tests yields an angle of internal friction greater than 30 degrees, the larger test value may be used for design, up to a maximum value of 36 degrees.

An external stability check at critical wall stations showing Capacity Demand Ratio (CDR) for sliding, eccentricity, and bearing checks is provided by the department and are provided on the wall plans.

The design of the wall by the contractor shall consider the internal and compound stability of the wall mass according to AASHTO LRFD 11.10.6. The internal stability shall include soil reinforcement pullout, soil reinforcement rupture, and wall facing-reinforcement connection failure at each soil reinforcement level. The design shall be performed using the Simplified Method or Coherent Gravity Method. Calculations for factored stresses and resistances shall be based upon assumed conditions at the end of the design life. Compound stability shall be computed for the applicable strength limits. Sample analyses and hand calculations shall be submitted to verify the output of any software used. The design calculations and notes shall clearly indicate the Capacity to Demand Ratios (CDR) for all internal and external stabilities as defined in AASHTO LRFD.

Wall facing units shall be designed according to AASHTO LRFD 11.10.2.3.

The minimum length of soil reinforcement measured from the back face of the wall shall be equal to 0.7 of the wall height, or as shown on the plan. In no case shall this length be less than 6.0 feet. The soil reinforcement length shall be the same from the bottom to the top of the wall. All soil reinforcement layers shall be connected to facings. The soil reinforcement shall extend a minimum of 3.0 feet beyond the theoretical failure plane in all cases. The maximum vertical spacing of soil reinforcement layers shall be two times the block width (front face to back face) or 32 inches, whichever is less. The first (bottom) layer of reinforcement shall be placed no further than 12 inches above the top of the leveling pad or the height

of the block, but at least one block height above the leveling pad. The last (top) layer of soil reinforcement shall be no further than 21 inches below the top of the uppermost block.

All soil reinforcement required for the reinforced soil zone shall be connected to the wall facing.

Soil reinforcement shall be fabricated or designed to avoid piling, drainage structures or other obstacles in the fill without field modifications. Unless approved by the Bureau of Structures cutting or altering of the basic structural section of either the strip or grid at the site is prohibited, a minimum clearance of 3" shall be maintained between any obstruction and reinforcement, and splicing reinforcement is not allowed.

The minimum embedment of the wall shall be 1 foot 6 inches below finished grade, or as given on the plans. All walls shall be provided with a concrete leveling pad. Minimum wall embedment does not include the leveling pad depth. Step the leveling pad to follow the general slope of the ground line. Frost depth shall not be considered in designing the wall for depth of leveling pad.

Wall facing units shall be installed on a leveling pad.

### **B.3 Wall System Components**

Materials furnished for wall system components under this contract shall conform to the requirements of this specification. All documentation related to material and components of the wall systems specified in this subsection shall be submitted to the engineer.

#### **B.3.1 Wall Facing**

Wall facing units shall consist of precast modular concrete blocks. Furnish concrete produced by a dry-cast or wet-cast process. Concrete for all blocks shall not contain less than 565 pounds of cementitious materials per cubic yard. The contractor may use cement conforming to standard spec. [501.2.1](#) or may substitute for portland cement at the time of batching conforming to standard spec. [501.2.6](#) for fly, [501.2.7](#) for slag, or [501.2.8](#) for other pozzolans. In either case the maximum total supplementary cementitious content is limited to 30% of the total cementitious content by weight.

Dry-cast concrete blocks shall be manufactured according to ASTM C1372 and this specification.

All units shall incorporate a mechanism or devices that develop a mechanical connection between vertical block layers. Units that are broken, have cracks wider than 0.02" and longer than 25% of the nominal height of the unit, chips larger than 1", have excessive efflorescence, or are otherwise deemed unacceptable by the engineer, shall not be used within the wall. A single block front face style shall be used throughout each wall. The color and surface texture of the block shall be as given on the plan.

The top course of facing units shall be as noted on the plans, either;

- Solid precast concrete unit designed to be compatible with the remainder of the wall. The finishing course shall be bonded to the underlying facing units with a durable, high strength, flexible adhesive compound compatible with the block material.
- A formed cast-in-place concrete cap. A cap of this type shall have texture, color, and appearance, as noted on the plans. The vertical dimension of the cap shall not be less than 3 1/2 inches. Expansion joints shall be placed in the cap at a maximum spacing of 20 feet unless noted otherwise on the plan. Use Grade A concrete conforming to standard spec 501 as modified in standard spec 716. Provide QMP for cast in place cap and coping concrete as specified in standard spec 716, Class II Concrete.

Block dimensions may vary no more than  $\pm 1/8$  inch from the standard values published by the manufacturer. Blocks must have a minimum width (front face to back face) of 8 inches. The minimum front face thickness of blocks shall be 4 inches measured perpendicular from the front face to inside voids greater than 4 square inches. The minimum allowed thickness of any other portions of the block is 1 3/4 inches. The front face of the blocks shall conform to plan requirements for color, texture, or patterns.

If pins are used to align modular block facing units, they shall consist of a non-degrading polymer, or hot dipping galvanized steel and be made for the express use with the modular block units supplied, to develop mechanical interlock between facing unit block layers. Connecting pins shall be capable of holding the wall in the proper position during backfilling. Furnish documentation that establishes and substantiates the design life of such devices.

All block materials shall be furnished palletted and banded, with every pallet marked for quantity, lot number, lot size, manufacturing plant, and manufacturing date(s). Materials furnished loose or unmarked will be rejected. Rejected materials shall be removed from the project at no cost to the department.

### B.3.1.1 Material Testing

Perform or procure quality control testing of project materials according to the following requirements:

Test	Method	Requirement	
		Dry-cast	Wet-cast
Compressive Strength (psi)	ASTM C140 or ASTM C39 <sup>[4]</sup>	5000 min.	4000 min.
Air Content (%)	AASHTO T152 <sup>[4]</sup>	N/A	6.0 +/-1.5
Water Absorption (%)	ASTM C140 <sup>[3]</sup>	6 max.	N/A
Freeze-Thaw Loss (%) 40 cycles, 5 of 5 samples 50 cycles, 4 of 5 samples	ASTM C1262 <sup>[1][2][3]</sup>	1.0 max. 1.5 max.	N/A

<sup>[1]</sup> Test shall be run using a 3% saline solution and blocks greater than 45 days old.

<sup>[2]</sup> Test results that meet either of the listed requirements for Freeze-Thaw Loss are acceptable.

<sup>[3]</sup> An independent testing laboratory shall control and conduct all sampling and testing under ASTM C140/Water Absorption and ASTM C1262. Prior to sampling, the manufacturer shall identify materials by lot. Five blocks per lot shall be randomly selected for testing. Solid blocks used as a finishing or top course shall not be selected. The selected blocks shall remain under the control of the person who conducted the sampling until shipped or delivered to the testing laboratory.

<sup>[4]</sup> The manufacturer may perform their own quality control testing under ASTM C140/Compressive Strength, ASTM C39, and AASHTO T152, if qualified for this work under the requirements for plant certification.

The contractor and fabricator shall coordinate with the independent testing agent (if used) to ensure that strength and air content samples can be taken appropriately during manufacturing. At the time of delivery of materials, furnish the engineer a certified report of test from an AASHTO-registered or ASTM-accredited independent testing laboratory for each lot furnished.

The certified test report shall include the following:

- Project ID
- Production process used (dry-cast or wet-cast)
- Name and location of testing facility
- Name of sampling technician
- Lot number, lot size, and date(s) of fabrication.

Quality control testing of project materials shall be completed not more than 18 months prior to delivery. Lot size shall not exceed the maximum testing frequencies, which shall not exceed 5000 blocks for dry-cast blocks and the lesser of 150 CY or 1 day's production for wet-cast blocks. Test results will represent all blocks within the lot. Each pallet of blocks delivered shall bear lot identification information. Block lots that do not meet the requirements of this specification or blocks without supporting reports will be rejected and shall be removed from the project at no expense to the department.

Nonconforming materials will be subject to evaluation according to standard spec 106.5.

### B.3.2 Leveling Pad

Provide an unreinforced cast-in-place concrete leveling pad. Use Grade A concrete conforming to standard spec 501 as modified in standard spec 716. Provide QMP for leveling pad concrete as specified in standard spec 716, Class III Concrete.

The minimum width of the concrete leveling pad shall be as wide as the proposed blocks plus 6-inches, with 6-inches of the leveling pad extending beyond the front face of the blocks. The minimum thickness of the leveling pad shall be 6-inches.

### B.3.3 Backfill

Furnish and place backfill for the wall as shown on the plans and as hereinafter provided.

Wall Backfill, Type A, shall comply with the requirements for Coarse Aggregate No. 1 as given in standard spec 501.2.5.4.4. All backfill placed within a zone from the top of the leveling pad to the top of the final layer of wall facing units and within 1 foot behind the back face of the wall shall be Wall Backfill, Type A. This includes all material used to fill openings in the wall facing units.

Wall Backfill, Type B, shall be placed in a zone extending horizontally from 1 foot behind the back face of the wall to 1 foot beyond the end of the reinforcement and extending vertically from the top of the leveling pad to a minimum of 3 inches above the final reinforcement layer.

Use natural sand or a mixture of sand with gravel, crushed gravel or crushed stone. Do not use foundry sand, bottom ash, blast furnace slag, crushed/recycled concrete, crushed/milled asphaltic concrete or other potentially corrosive material.

Provide material conforming to the following gradation requirements as per AASHTO T27.

Sieve Size	% by Weight Passing
1 inch	100
No. 40	0 - 60
No. 200	0 - 15

The material shall have a liquid limit not greater than 25, as per AASHTO T89, and a plasticity index not greater than 6, as per AASHTO T90. Provide the percent by weight, passing the #4 sieve.

In addition, backfill material Type A and Type B shall meet the following requirements.

Test	Method	Value
pH	AASHTO T-289	4.5-9.0
Sulfate content <sup>[1]</sup>	AASHTO T-290	200 ppm max.
Chloride content <sup>[1]</sup>	AASHTO T-291	100 ppm max.
Electrical Resistivity <sup>[1]</sup>	AASHTO T-288	3000 ohm-cm min.
Organic Content <sup>[1]</sup>	AASHTO T-267	1.0% max.
Angle of Internal Friction	AASHTO T-236 <sup>[2]</sup>	30 degrees min. (At 95.0% of maximum density and optimum moisture, per AASHTO T99, or as modified by C.2)

<sup>[1]</sup> Requirement does not apply to walls with non-metallic reinforcement and non-metallic connectors.

<sup>[2]</sup> If the amount of P-4 material is greater than 60%, use AASHTO 236 with a standard-size shear box. Test results of this method may allow the use of larger angles of internal friction, up to the maximum allowed by this specification.

If the amount of P-4 material is less than or equal to 60%, two options are available to determine the angle of internal friction. The first method is to perform a fractured faces count, per ASTM D5821, on the R-4 material. If more than 90% of the material is fractured on one face and more than 50% is fractured on two faces, the material meets the specifications, and the angle of internal friction can be assumed to be 30 degrees. The second method allows testing all P-1" material, as per AASHTO T-236, with a large shear box. Test results of this second method may allow the use of larger angles of internal friction, up to the maximum allowed by this specification.

Prior to placement of the backfill, obtain and furnish to the engineer a certified report of test results that the backfill material complies with the requirements of this specification. Specify the method used to determine the angle of internal friction. This certified report of test shall be less than 6 months old. Tests will be performed by a certified independent laboratory. In addition, when backfill characteristics and/or sources change, provide a certified report of tests for the new backfill material. Additional certified report of tests are also required. These additional backfill tests may be completed at the time of material production or material placement, with concurrence of the engineer. If this additional testing is completed at the time of material production, complete testing for every 2000 cubic yards of backfill or portion thereof. If this additional testing is completed at the time of material placement, complete testing for every 2000 cubic yards of backfill, or portion thereof, used per wall. For the additional required testing for every 2000 cubic yards of backfill placement, if the characteristic of the backfill and/or the source has not changed then Angle of Internal Friction tests are not included in the additional required testing. All certified reports of test results shall be less than 6 months old and performed by a certified independent laboratory.

### B.3.4 Soil Reinforcement

#### B.3.4.1 Geogrids

Geogrid supplied as reinforcing members shall be manufactured from long chain polymers limited to polypropylene, high-density polyethylene, polyaramid, and polyester. Geogrids shall form a uniform rectangular grid of bonded, formed, or fused polymer tensile strands crossing with a nominal right angle orientation. The minimum grid aperture shall be 0.5 inch. The geogrid shall maintain dimension stability during handling, placing, and installation. The geogrid shall be insect, rodent, mildew, and rot resistant. The geogrid shall be furnished in a protective wrapping that shall prevent exposure to ultraviolet radiation and damage from shipping or handling. The geogrid shall be kept dry until installed. Each roll shall be clearly marked to identify the material contained.

The wall supplier shall provide the nominal long-term design strength ( $T_{al}$ ) and nominal long-term connection strength,  $T_{alc}$  as discussed below.

#### Nominal Long-Term Design Strength ( $T_{al}$ )

The wall supplier shall supply the nominal long-term design strength ( $T_{al}$ ) used in the design for each reinforcement layer and shall be determined by dividing the Ultimate Tensile Strength ( $T_{ult}$ ) by the factors  $RF_{ID}$ ,  $RF_{CR}$ ,  $RF_D$ .

Hence,

$$T_{al} = \frac{T_{ult}}{RF_{ID} \times RF_{CR} \times RF_D}$$

where:

- $T_{ult}$  = Ultimate tensile strength of the reinforcement determined from wide width tensile tests (ASTM D6637) for geogrids based on the minimum average roll value (MARV) for the product.
- $RF_{ID}$  = Strength reduction factor to account for installation damage to the reinforcement. In no case shall  $RF_{ID}$  be less than 1.1.
- $RF_{CR}$  = Strength reduction factor to prevent long-term creep rupture of the reinforcement. In no case shall  $RF_{CR}$  be less than 1.2.
- $RF_D$  = Strength reduction factor to prevent rupture of the reinforcement due to chemical and biological degradation. In no case shall  $RF_D$  be less than 1.1.

Values for  $RF_{ID}$ ,  $RF_{CR}$ , and  $RF_D$  shall be determined from product specific test results. Guidelines for determining  $RF_{ID}$ ,  $RF_{CR}$ , and  $RF_D$  from product specific data are provided in FHWA Publication No. FHWA-NHI-10-024 and FHWA-NHI-10-025 "Design and Construction of Mechanically Stabilized Earth Walls and Reinforced Soil Slopes".

#### Nominal Long-term Connection Strength $T_{ac}$

The nominal long term connection strength,  $T_{ac}$ , shall be based on laboratory geogrid connection tests between wall facing and geogrids.  $T_{ac}$  shall be as given below

$$T_{ac} = \frac{T_{ult} * CR_{cr}}{RF_D}$$

where:

- $T_{ac}$  = Nominal long-term reinforcement facing connection strength per unit reinforcement width at a specified confining pressure.
- $T_{ult}$  = Ultimate tensile strength of the reinforcement for geogrids defined as the minimum average roll value (MARV) for the product.
- $CR_{cr}$  = Long term connection strength reduction factor to account for reduced ultimate strength resulting from connection.
- $RF_D$  = Strength reduction factor to prevent rupture of the reinforcement due to chemical and biological degradation.

$T_{ac}$  shall be developed from the tests conducted by an independent laboratory on the same facing blocks and geogrids as proposed for the wall and shall cover a range of overburden pressures comparable to those anticipated in the proposed wall. The connection strength reduction factor  $CR_{cr}$  shall be determined according to long-term connection test as described in Appendix B of FHWA Publication No. FHWA-NHI 10-025 "Design and Construction of Mechanically Stabilized Earth Walls and Reinforced Soil Slopes".  $CR_{cr}$  may also be obtained from the short term connection test meeting the requirements of NCMA test method SRWU-1 in Simac et al 1993 or ASTM D4884.

The contractor shall provide a manufacturer's certificate that the  $T_{ult}$  (MARV) of the supplied geogrid has been determined according to ASTM D4595 or ASTM D6637 as appropriate. Contractor shall also provide block to block and block to reinforcement connection test reports prepared and certified by an independent laboratory. Also provide calculations according to AASHTO LRFD, and using the results of laboratory tests, that the block-geogrid connections shall be capable of resisting 100% of the maximum tension load in the soil reinforcements at any level within the wall, for the design life of the wall system.

#### **B.3.4.2 Galvanized Metal Reinforcement**

In lieu of polymeric geogrid earth reinforcement, galvanized metal reinforcement may be used. Design and materials shall be according to AASHTO LRFD 11.10.6.4.2. The design life of steel soil reinforcements shall also comply with AASHTO LRFD. Steel soil reinforcement shall be prefabricated into single or multiple elements before galvanizing.

### **C Construction**

#### **C.1 Excavation and Backfill**

Excavation and preparation of the foundation for the MSE wall and the leveling pad shall be according to standard spec 206. The volume of excavation covered is limited to the width of the reinforced mass and to the depth of the leveling pad unless shown or noted otherwise on the plan. At the end of each working day, provide good temporary drainage such that the backfill shall not become contaminated with run-off soil or water if it should rain. Do not stockpile or store materials or large equipment within 10 feet of the back of the wall.

Place backfill materials in the areas as indicated on the plans and as detailed in this specification. Backfill lifts shall be no more than 8-inches in depth, after compaction. Backfilling shall closely follow erection of each course of wall facing units.

Conduct backfilling operations in such a manner as to prevent damage or misalignment of the wall facing units, soil reinforcement, or other wall components. At no expense to the department, correct any such damage or misalignment as directed by the engineer. A field representative of the wall supplier shall be available during wall construction to provide technical assistance to the contractor and the engineer.

Place and compact the MSE backfill to the level of the next higher layer of MSE reinforcement before placing the MSE reinforcement or connecting it to the wall facing. Place and compact material beyond the reinforced soil zone to allow for proper compaction of material within the reinforced zone. The MSE reinforcement shall lay horizontally on top of the most recently placed and compacted layer of MSE backfill.

Do not operate tracked or wheeled equipment on the backfill within 3 feet from the back face of modular blocks. The engineer may order the removal of any large or heavy equipment that may cause damage or misalignment of the wall facing units.

## **C.2 Compaction**

Compact wall backfill Type A with at least three passes of lightweight manually operated compaction equipment acceptable to the engineer.

Compact all backfill Type B as specified in standard spec 207.3.6. Compact the backfill Type B to 95.0% of maximum dry density as determined by AASHTO T-99 (modified to compute densities to the nearest 0.1 pcf).

Ensure adequate moisture is present in the backfill during placement and compaction to prevent segregation and to help achieve compaction.

Compaction of backfill within 3 feet of the back face of the wall should be accomplished using lightweight compaction devices. Use of heavy compaction equipment or vehicles should be avoided within 3 feet of the modular blocks. Do not use sheepfoot or padfoot rollers within the reinforced soil zone.

A minimum of 6 inches of backfill shall be placed over the MSE reinforcement prior to working above the reinforcement.

## **C.3 Wall Components**

### **C.3.1 General**

Erect wall facing units and other associated elements according to the wall manufacturer's construction guide and to the lines, elevations, batter, and tolerances as shown on the plans. Center the initial layer of facing units on the leveling pad; then level them and properly align them. Fill formed voids or openings in the facing units with wall backfill, Type A. Remove all debris on the top of each layer of facing units, before placing the next layer of facing units.

Install all pins, rods, clips, or other devices used to develop mechanical interlock between facing unit layers according to the manufacturer's directions.

The MSE reinforcement shall lay horizontally on the top of the most recently placed and compacted layer of MSE backfill. Bending of MSE reinforcement that result in a kink in the reinforcement shall not be allowed. If skewing of the reinforcement is required due to obstructions in the reinforced fill, the maximum skew angle shall not exceed 15 degrees from the normal position unless a greater angle is shown on the plans. The adequacy of the skewed reinforcement in such a case shall be addressed by supporting calculations.

### **C.3.2 Leveling Pad**

Provide an unreinforced cast-in-place concrete leveling pad as shown on the plans. Vertical tolerances shall not exceed 3/4-inch when measured along a 10-foot straight edge. Allow the concrete to set at least 12 hours prior to placing wall facing units.

The bottom row of wall facing units shall be horizontal and 100% of the unit surface shall bear on the leveling pad.

### **C.3.3 Soil Reinforcement**

#### **C.3.3.1 Geogrid Layers**

Place soil reinforcement at the positions and to the lengths as indicated on the accepted shop drawings. Take care that backfill placement over the positioned soil reinforcement elements does not cause damage or misalignment of these elements. Correct any such damage or misalignment as directed by the engineer. Do not operate wheeled or tracked equipment directly on the soil reinforcement. A minimum cover of 6 inches is required before such operation is allowed.



Place and anchor geogrid material between wall unit layers in the same manner as used to determine the Geogrid Block-to-Connection Strength. Place the grid material so that the machine direction of the grid is perpendicular to the wall face. Each grid layer shall be continuous throughout the lengths indicated on the plans. Join grid strips with straps, rings, hooks or other mechanical devices to prevent movement during backfilling operations. Prior to placing backfill on the grid, pull the grid taut and hold in position with pins, stakes or other methods approved by the engineer.

#### **C.3.3.2 Steel Layers**

Place the steel reinforcement full width in one piece as shown on the plans. No splicing will be allowed. Maintain elements in position during backfilling.

### **C.4 Quality Management Program**

#### **C.4.1 Quality Control Plan**

Submit a comprehensive written quality control plan to the engineer at or before the pre-construction meeting. Do not perform MSE wall construction work before the engineer reviews and accepts the plan. Construct the project as the plan provides.

Do not change the quality control plan without the engineer's review and acceptance. Update the plan with changes as they become effective. Provide a current copy of the plan to the engineer and post in the contractor's laboratory as changes are adopted. Ensure that the plan provides the following elements:

1. An organizational chart with names, telephone numbers, current certifications and/or titles, and roles and responsibilities of QC personnel.
2. The process used to disseminate QC information and corrective action efforts to the appropriate persons. Include a list of recipients, the communication process that will be used, and action time frames.
3. A list of source locations, section and quarter descriptions, for all aggregate materials requiring QC testing.
4. Descriptions of stockpiling and hauling methods.
5. An outline for resolving a process control problem. Include responsible personnel, required documentation, and appropriate communication steps.
6. Location of the QC laboratory, retained sample storage, and other documentation.
7. A summary of the locations and calculated quantities to be tested under this provision.
8. A proposed sequencing plan of wall construction operations and random test locations.

#### **C.4.2 Quality Control Personnel**

Perform the quality control sampling, testing, and documentation required under this provision using HTCP certified technicians. Have a HTCP Grading Technician I (GRADINGTEC-I); or Assistant Certified Technician, Grading (ACT-GRADING); or Aggregate Technician I (AGGTEC-I); or Assistant Certified Technician, Aggregate (ACT-AGG) present at each grading site during all wall backfill placement, compaction, and nuclear testing activities. Have a HTCP Nuclear Density Technician I (NUCDENSITYTEC-I) or Assistant Certified Technician, Nuclear Density Gauge Operator (ACT-NUC) perform field density and field moisture content testing.

If an Assistant Certified Technician (ACT) is performing sampling or testing, a certified technician must coordinate and take responsibility for the work an ACT performs. Have a certified technician Ensure that all sampling and testing is performed correctly, analyze test results, and post resulting data. No more than one ACT can work under a single certified technician.

#### **C.4.3 Equipment**

Furnish the necessary equipment and supplies for performing quality control testing. Ensure that all testing equipment conforms to the equipment specifications applicable to the required testing methods. The engineer may inspect the measuring and testing devices to confirm both calibration and condition. Calibrate all testing equipment according to the CMM and maintain a calibration record at the laboratory.

Furnish nuclear gauges from the department's approved product list at:

<https://wisconsindot.gov/Pages/doing-bus/eng-consultants/cnslt-rsrcs/tools/appr-prod/default.aspx>

Ensure that the nuclear gauge manufacturer or an approved calibration service calibrates the gauge the same calendar year it is used on the project. Retain a copy of the calibration certificate with the gauge.

Conform to AASHTO T310 and CMM 8-15 for density testing and gauge monitoring methods.

Split each Proctor sample and identify so as to provide comparison with the department's test results. Unless the engineer directs otherwise, retain the QC split samples for 14 calendar days and promptly deliver the department's split samples to the department.

#### **C.4.4 Documentation**

- (1) Document all observations, inspection records, and process adjustments daily. Submit test results to the department's project materials coordinator on the same day they become available.
- (2) Use forms provided in CMM Chapter 8. Note other information in a permanent field record and as a part of process control documentation enumerated in the contractor's quality control plan. Enter QC data and backfill material certified report results into the applicable materials reporting system (MRS) software within 5 business days after results are available.
- (3) Submit final testing records and other documentation to the engineer electronically within 10 business days after all contract-required information becomes available. The engineer may allow submission of scanned copies of hand-written documentation.

#### **C.4.5 Quality Control (QC) Testing**

Perform compaction testing on the backfill. Conform to CMM 8-15 for testing and gauge monitoring methods. Conduct testing at a minimum frequency of 1 test per 150 cubic yards of backfill, or major portion thereof in each lift. A minimum of one test for every lift is required. Deliver documentation of all compaction testing results to the engineer at the time of testing.

Perform 1 gradation test every 750 cubic yards of fill and one 5-point Proctor test (or as modified in C.2) every 2,250 cubic yards of fill. Provide the region split samples of both within 72 hours of sampling, at the region laboratory. Test sites shall be selected using ASTM Method D3665. Provide Proctor test results to the engineer within 48 hours of sampling. Provide gradation test results to the engineer within 24 hours of sampling.

#### **C.4.6 Department Testing**

##### **C.4.6.1 General**

- (1) The department will conduct verification testing to validate the quality of the product and independent assurance testing to evaluate the sampling and testing. The department will provide the contractor with a listing of names and telephone numbers of all QV and IA personnel for the project and provide test results to the contractor within 2 business days after the department obtains the sample.

##### **C.4.6.2 Quality Verification (QV) Testing**

- (1) The department will have an HTCP technician, or ACT working under a certified technician, perform QV sampling and testing. Department verification testing personnel must meet the same certification level requirements specified in C.4.2 for contractor testing personnel for each test result being verified. The department will notify the contractor before sampling so the contractor can observe QV sampling.
- (2) The department will conduct QV tests at the minimum frequency of 30% of the required contractor density, Proctor and gradation tests.
- (3) The department will locate density tests and gradation samples randomly, at locations independent of the contractor's QC work. The department will split each Proctor and gradation QV sample, testing half for QV, and retaining the remaining half for 10 business days.
- (4) The department will conduct QV Proctor and gradation tests in a separate laboratory and with separate equipment from the contractor's QC tests. The department will use the same methods specified for QC testing.

- (5) The department will assess QV results by comparing to the appropriate specification limits. If QV test results conform to this special provision, the department will take no further action. If density QV test results are nonconforming, the area shall be reworked until the density requirements of this special provision are met. If the gradation test results are nonconforming, standard spec 106.5 will apply. Differing QC and QV nuclear density values of more than 1.5 pcf will be investigated and resolved. QV density tests will be based on the appropriate QC Proctor test results, unless the QV and QC Proctor result difference is greater than 3.0 pcf. Differing QC and QV Proctor values of more than 3.0 pcf will be investigated and resolved.

#### **C.4.6.3 Independent Assurance (IA)**

- (1) Independent assurance is unbiased testing the department performs to evaluate the department's QV and the contractor's QC sampling and testing, including personnel qualifications, procedures, and equipment. The department will perform an IA review according to the department's independent assurance program. That review may include one or more of the following:
  1. Split sample testing.
  2. Proficiency sample testing.
  3. Witnessing sampling and testing.
  4. Test equipment calibration checks.
  5. Reviewing required worksheets and control charts.
  6. Requesting that testing personnel perform additional sampling and testing.
- (2) If the department identifies a deficiency, and after further investigation confirms it, correct that deficiency. If the contractor does not correct or fails to cooperate in resolving identified deficiencies, the engineer may suspend placement until action is taken. Resolve disputes as specified in C.4.6.4.

#### **C.4.6.4 Dispute Resolution**

- (1) The engineer and contractor should make every effort to avoid conflict. If a dispute between some aspect of the contractor's and the engineer's testing program does occur, seek a solution mutually agreeable to the project personnel. The department and contractor may review the data, examine data reduction and analysis methods, evaluate sampling and testing procedures, and perform additional testing. Use ASTM E178 to evaluate potential statistically outlying data.
- (2) Production test results, and results from other process control testing, may be considered when resolving a dispute.
- (3) If the project personnel cannot resolve a dispute, and the dispute affects payment or could result in incorporating non-conforming product or work, the department will use third party testing to resolve the dispute. The department's central office laboratory, or a mutually agreed on independent testing laboratory, will provide this testing. The engineer and contractor will abide by the results of the third party tests. The party in error will pay service charges incurred for testing by an independent laboratory. The department may use third party test results to evaluate the quality of questionable materials and determine the appropriate payment. The department may reject material or otherwise determine the final disposition of nonconforming material as specified in standard spec 106.5.

### **C.5 Geotechnical Information**

Geotechnical data to be used in the design of the wall is given on the wall plan. After completing wall excavation of the entire reinforced soil zone, notify the department and allow the Regional Soils Engineer two working days to review the foundation.

#### **D Measurement**

The department will measure Wall Modular Block Mechanically Stabilized Earth by the square foot, acceptably completed. The department will compute the measured quantity from the theoretical pay limits the contract plans show. The department will make no allowance for wall area constructed above or below the theoretical pay limits. All work beyond the theoretical pay limits is incidental to the cost of work. The department will make no allowance for as-built quantities.

## E Payment

The department will pay for accepted measured quantities at the contract unit price under the following bid item:

ITEM NUMBER	DESCRIPTION	UNIT
SPV.0165.002	Wall Modular Block Mechanically Stabilized Earth R-67-159	SF

Payment is full compensation for supplying a design and shop drawings; preparing the site, including all necessary excavation and disposal of materials; supplying all necessary wall components to produce a functional wall system including cap, copings, leveling pad, and leveling pad steps; constructing the retaining system and providing temporary drainage; providing backfill, backfilling, compacting, developing/completing/documenting the quality management program, and performing compaction testing.

The department will pay separately for parapets, traffic barriers, railings, and other items above the wall cap or coping.

## 127. Concrete Barrier Wall Surface Repair, Item SPV.0165.003.

### A Description

This special provision describes concrete barrier wall surface repair as shown on the plans.

### B Materials

Furnish an approved non-shrink commercial grout prepared according to the manufacturer's specifications. Provide manufacturer information to the engineer. At the interface of the existing concrete and grout patch, provide standardized commercial concrete anchor screws to aid in binding the two materials.

### C Construction

#### Preparation

1. Clean the entire surface of the repair receiving the new grout by using a suitable mechanical chipper. Accomplish this in a way that prevents hooking or tearing the reinforcing steel and that removes any deteriorated or loose concrete from the wall.
2. Blast clean the entire surface of all exposed reinforcing steel.
3. Clean the surface receiving the new grout by mechanically dislodging contamination or debris and removing loose particles and dust with high pressure water or air. Ensure that no free-standing water remains before placing grout and that cleaning water conforms to standard spec 501.2.4.
4. Install concrete anchor screws by drilling and placing in epoxy at the depth and quantity shown in the plans.

#### Placement

1. Place the non-shrink commercial grout according to the manufacturer's specifications. Provide forming as needed to maintain the line and shape of the existing barrier. Remove forms only after curing has occurred per the manufacturer's requirements.
2. Form or saw contraction joints to the width, depth and at the locations of the existing barrier.

### D Measurement

The department will measure Concrete Barrier Wall Surface Repair by the square foot, acceptably completed.

## E Payment

The department will pay for measured quantities at the contract unit price under the following bid item:

ITEM NUMBER	DESCRIPTION	UNIT
SPV.0165.003	Concrete Barrier Wall Surface Repair	SF

Payment is full compensation for removing and disposing of deteriorated concrete, for sawing, for cleaning reinforcing steel, for placing concrete anchors, for patching materials, for forming, furnishing, hauling, placing, curing, and protecting all materials.

## 128. Methacrylate Flood Seal, Item SPV.0180.001.

### A Description

This special provision describes preparation of concrete bridge deck surfaces, furnishing and applying a protective methacrylate deck sealer and broadcast sand, and any incidentals necessary to complete the project as specified or as shown in plans or as authorized by the engineer.

### B Materials

The deck sealer shall consist of a methacrylate sealant, sand to prefill cracks, and broadcast sand.

#### B.1 Methacrylate Sealant

The following methacrylate sealants are acceptable for use provided that the requirements of this specifications are met:

Product	Manufacturer
MasterSeal 630 (formerly Degadeck Crack Sealer Plus)	BASF
T-78	Transpo Industries
KBP 204 P SEAL	Kwik Bond Polymers

or an approved equal

#### B.2 Fine Grade Sand

Provide fine grade abrasive sand for (20/40 abrasive) prefilling large cracks unable to be prefilled with sealant alone.

Submit sand material data to the engineer for review and address all written comments. Submit storage and use plan to the engineer documenting procedures for maintaining dry sand and within gradation requirements above.

#### B.3 Broadcast Sand

Provide a commercial quality dry blast sand with an average absorption of no more than 1%. 95% of the sand shall pass the No. 8 sieve and at least 95% shall be retained on the No. 20 sieve.

### C Construction

#### C.1 General

##### C.1.1 Pre-Installation Conference

Conduct a pre-installation conference with the manufacturer's representative prior to construction to establish procedures for maintaining optimum working conditions, coordination of work, all necessary safety precautions, and application considerations. Furnish the engineer with a copy of the recommended procedures and the manufacturer's instructions.

A manufacturer's representative familiar with the seal system installation procedures shall be present during the first surface preparation and methacrylate sealer placement to provide quality assurance that the work is being performed properly.

##### C.1.2 Contractor Personnel Requirements

Experienced personnel are required to be actively present during the sealant application.

A technical representative from the sealer manufacturer must be present during first application. The need for manufacturer's representative may be waived for subsequent applications if the contractor provides evidence and reference contacts for work involving at least 5 bridges treated with the same products and within the last two years. Contractor experience record in no way relieves the contractor from applying according to this specification and as recommended by the manufacturer.

##### C.1.3 Material Storage and Safety Plan

Store resin materials in their original containers in a dry area. Store and handle materials according to the manufacturer's recommendations. Store all aggregates in a dry environment and protect aggregates from contaminants on the job site.

Safety Plan: Prior to arrival of the product on the job site, provide a product shipping, storage, and use safety plan to detail how the product will be delivered and stored on site in a manner that will not allow the constituent components to come in contact with each other in the event of a spill or container leakage. If the product initiator used consists of a metal drier and peroxide, the two components shall not be mixed directly together. The safety plan must also include a description of the safety training workers applying the product have received regarding the product's use, and list any and all safety precautions which must be taken during application of the product.

## **C.2 Surface Preparation**

Abrasive blast clean the area to be treated (either entire deck or portion of the deck to be sealed in one placement when staged construction is being employed) to remove existing sealants, including epoxy crack sealant, from the surface of the bridge deck prior to applying deck sealer. Blasting shall remove all dirt, oil, asphalt, rubber, curing compound, paint, carbonation, grease, slurry, membranes, striping, rust, weak surface mortar, laitance, and other foreign or potentially detrimental materials. Thoroughly blast clean with hand-held equipment any areas inaccessible by the shotblasting equipment. Do not perform surface preparation more than 24 hours prior to the application of the methacrylate sealer. Blasting should not damage the underlying substrate.

If the area to be treated is reopened to traffic prior to placement of the sealer, the deck should be reinspected for any contaminants and subsequently remove them by use of abrasive sand blasting or shotblasting at no additional cost.

The engineer may consider alternate surface preparation methods per the methacrylate sealer system manufacturer's recommendations. The engineer must approve the final surface profile and deck cleanliness prior to the contractor placing the methacrylate sealer.

Just prior to methacrylate sealer placement, clean all dust, debris, and concrete fines from the deck surface including vertical faces of curbs and barrier walls up to a height of 2-in above the surface with compressed air. Use a direct 125 psi air blast, from a compressor unit with a minimum pressure of 365 feet 3 / min., over the entire surface to remove all dust and debris paying special attention to carefully clean all deck cracks. Use a suitable oil trap between the air supply and nozzle. Use ASTM D4285 "Standard Test Method for Indicating Oil or Water in Compressed Air" to ensure the compressed air is oil and moisture free. The air stream must be free of oil and moisture. Any grease, oil, or other foreign matter that rests on or has absorbed into the concrete shall be removed completely. Provide shielding as necessary to prevent dust or debris from striking vehicular traffic. The engineer shall approve the prepared surface prior to applying the deck sealer.

Perform a visual inspection of the roadway surface, and sidewalk where applicable. Locate and mark all cracks greater than 0.03 inch appearing on the top for prefilling.

Prefill cracks greater than 0.03 inch - Prior to sealer application, prefill cracks with the same methacrylate sealer or a pre-promoted version of the sealer. Where sealant soaks-in/withdraws from top of crack, place fine grade abrasive sand (20/40 abrasive) in crack and reapply sealant to seal to top of crack. When sealant has not retreated after gel time, the crack is considered prefilled. Do not fill crack with sand beyond top of concrete surface.

Protect drains, expansion joints, access hatches, or other appurtenances on the deck from damage by the shot and sand blasting operations and from material adhering and entering. Tape or form all construction joints to provide a clean straight edge.

## **C.3 Application of the Methacrylate Deck Sealer**

Apply the methacrylate deck sealer conforming to the manufacturer's instructions.

Apply an approved methacrylate sealer to roadway surfaces on bridge deck or on surfaces as directed by the engineer. At least 30 calendar days before the start of the work, provide the engineer with the sealer Manufacturer's written instructions for application and use.

Air dry a wet deck for a minimum of 48 hours before applying the sealer. Dry time may be reduced to 24 hours if an approved ASTM D4263 moisture test reveals the deck concrete is dry. Do not apply sealer materials during wet weather conditions or if adverse weather conditions are anticipated within 12 hours of the completion of sealer application. Do not mix or apply any of these products at temperatures lower or higher than those specified in their product literature. Apply the sealant at the coolest time of the day within these limitations. Application by spray methods will not be permitted during windy conditions if the engineer predicts unsatisfactory results.

Do not thin or alter the methacrylate sealer unless specifically required in the Manufacturer's instructions.

Mix the sealer before and during its use as recommended by the Manufacturer. Distribute the sealant as a flood coat in a gravity-fed process by broom, roller, or with a spray bar near the surface so the spray pattern and coverage rates are reasonably uniform to the satisfaction of the engineer. Apply the sealant at a minimum rate of 90 ft<sup>2</sup> / gal.

Prior to completion of gel time of the flood seal and before broadcasting sand, broom uncured sealant in the direction of tining or deck grooves to promote maintenance of the deck texture for traction.

Broadcast sand to refusal into uncured resin to create traction and absorb sealant that is not penetrating into cracks. Broadcast approved sand into the wet, uncured resin no sooner than 10 minutes after applying resin but within gel time of product. Apply approved sand at a minimum rate of 2 pounds per square yard, completely covering the sealer.

Allow the sealant to dry according to the Manufacturer's instructions. Do not allow vehicular traffic onto the treated areas until the sealer has dried and the treated surfaces provide safe skid resistance and traction. Remove non-adhered sand from bridge deck and joints by power sweeping the deck and vacuuming the joints. Traffic or equipment will be allowed on the sealed deck after the engineer has determined:

1. The treated deck surface is tack-free and non-oily;
2. The sand cover adheres and resists brushing by hand;
3. Excess sand and absorbent material has been removed; and
4. No sealant material will be tracked beyond limits of treatment by traffic

#### **D Measurement**

The department will measure Methacrylate Flood Seal bid item in area by the square yard, acceptably completed.

#### **E Payment**

The department will pay for measured quantities at the contract unit price under the following bid item:

ITEM NUMBER	DESCRIPTION	UNIT
SPV.0180.001	Methacrylate Flood Seal	SY

Payment is full compensation for furnishing and applying the sealer to the bridge decks, as described above, including surface preparation, and all incidentals thereto; cleanup of excess sand in joints and on bridge deck; and restoration of damaged or marred striping.

### **129. Resin Binder High Friction Surface Treatment, Item SPV.0180.002.**

#### **A Description**

This special provision describes providing a high friction surface treatment (HFST) composed of aggregate in a resin binder on HMA or concrete pavements.

#### **B Materials**

##### **B.1 Resin Binder**

Supply a two-part thermosetting resin binder which is compatible with the pavement type, bonds to the pavement surface, holds the aggregate firmly in place in a broad range of climates including below-freezing temperatures, and meets the requirements specified in Table 1. Supply a primer if recommended by the resin binder manufacturer.

**Table 1. Resin Binder Properties**

Property	Requirements	Test Method*
Viscosity	7 – 30 poises	ASTM D2556 1-pint specimen
Gel Time	10-minute minimum	AASHTO M 235M/M 235 Type III
Ultimate Tensile Strength	2,000 – 5,000 psi @ 7 days	AASHTO M 235M/M 235 Type III
Elongation at Break	30% - 70% @ 7 days	AASHTO M 235M/M 235 Type III
Compressive Strength	≥ 1000 psi @ 3 hrs & ≥ 5000 psi @ 7 days	ASTM C579
Water Absorption	≤ 1.0 % @ 24-hr	AASHTO M 235M/M 235 Type III
Shore D Hardness	60 – 80 @ 7 days	ASTM D2240** Type 1 precision, Type D method
Cure Rate	≤ 3 hours (Dry Through Time)	ASTM D1640 50-55 wet mil thickness**
Adhesive Strength	250 psi @ 24 hours or 100% substrate failure	ASTM D4541**

\* Prepare samples per manufacturer's recommendation; cure two sets of specimens at 73 ± 2° F and at 50 ± 2° F; and test all specimens at 73 ± 2° F

\*\* Conduct testing on applicable pavement type

## B.2 Aggregate

Furnish calcined bauxite aggregate that is fractured or angular in shape; resistant to polishing and crushing; clean and free of surface moisture; free from silt, clay, asphalt, or other organic materials; compatible with the resin binder; and meet the properties and gradation requirements in Tables 2 and 3. Check with resin binder manufacturer for any compatibility requirements or **concerns**. The calcined bauxite will be delivered to the construction site in clearly labeled packaging; which protects the aggregate from any contaminants on the jobsite and from exposure to rain or other moisture.



**Table 2. Aggregate Properties**

Property	Requirements	Test Method
Moisture Content	$\leq 0.2\%$	AASHTO T 255
Fine Aggregate Angularity	$\geq 45\%$	AASHTO T 304, Method A
LA Wear	$\leq 10\%$ loss @ 100 revolutions and $\leq 25\%$ loss @ 500 revolutions	AASHTO T 96
Freeze-Thaw Soundness	$\leq 9\%$ loss @ 50, 16, or 25 cycles using Procedure A, B, or C, respectively	AASHTO T 103
Aluminum Oxide	$\geq 87\%$	ASTM C 25

**Table 3. Aggregate Gradation (AASHTO T27)**

Sieve Size	% Passing by Weight
No. 4	100
No. 6	95-100
No. 16	0-5
No. 30	0-1

**B.3 Approval of High Friction Surface Treatment**

A minimum of 20 working days before applying HFST, submit product data sheets and specifications from the manufacturer, and a certified test report from an independent laboratory verifying that the resin binder and the calcined bauxite aggregate meet all the requirements specified in Tables 1, 2 and 3. Documents must be dated within three years of project letting date; must be representative of the material used on the project.

If resin binder has not been previously used in Wisconsin, also submit a list of at least five reference projects where the resin binder has been used for similar applications and in locations that have similar climatic conditions as Wisconsin. Supply a description of the projects along with contact information of the facility owner.

If the engineer requests, provide samples of the resin binder and aggregate for department testing before applying HFST.

**C Construction****C.1 General**

The contractor will provide documentation showing HFST application experience from at least three previous projects completed for WisDOT or other agencies.

Conduct a meeting with the resin binder manufacturer representatives before applying HFST to establish procedures for maintaining optimum working conditions and coordination of the work. Submit recommended application procedures, including quality control practices, to the engineer for approval.

Ensure that a resin binder manufacturer representative is on site to provide technical assistance and quality assurance during surface preparation and for application of HFST.

Ensure that the resin binder components maintain their original properties during storage and handling. Store all aggregate in a dry environment and protect from contaminants on the job site.

## **C.2 Pavement Surface Preparation**

### **C.2.1 Pavement Surface Repair**

Remove visibly unsound or disintegrated areas of the pavement surface as the plans show or the engineer directs.

Check with resin binder manufacturer to ensure that products used for pavement repairs or patches are compatible with the resin HFST. Ensure that any new concrete or repairs are fully cured before placing the HFST. Allow a minimum 30-day curing time after placing new asphalt or concrete pavement before installing the HFST.

### **C.2.2 Surface Preparation**

Cover and protect utilities, drainage structures, expansion joints on bridge decks, and other structures within or adjacent to the application location to prevent materials from adhering to or entering those structures.

Remove pavement markings that are within the treatment area. Cover existing pavement markings adjacent to the application if they are to remain in place.

Pretreat all joints and cracks, or any portion of cracks, that are greater than ¼ inch wide, with the mixed binder resin system specified herein. Once the binder resin in the pretreated area has galled, the installation may proceed.

Completely remove any grease, oil or other deleterious materials resting on the pavement surface with a mild detergent solution, rinsed with clean potable water, and dried using a hot compressed air lance.

Ensure the pavement surface has no curing compound, loosely bonded mortar, pavement marking, or other foreign matter resting on the pavement surface.

Sufficiently clean HMA pavement surface using mechanical sweepers and high-pressure air wash with sufficient oil traps, just before applying HFST. Mechanically sweep all surfaces to remove dirt, loose aggregate, debris, and deleterious material. Vacuum sweep or air wash using a minimum of 180 cfm of clean and dry compressed air, all surfaces to remove all dust, debris, and deleterious material. Maintain air lance perpendicular to the surface and the tip of the air lance within 12 in. of surface.

Clean concrete pavement surface by shot blasting and vacuum sweeping. Shot blast all surfaces to remove all curing compound, loosely bonded mortar, surface carbonation, and deleterious material. After shot blasting, vacuum sweep or air wash, with a minimum of 180 cfm of clean and dry compressed air, all surfaces to remove all dust, debris, and deleterious material. Maintain air lance perpendicular to the surface and the tip of the air lance within 12 in. of the surface.

If the engineer requires additional verification of adequate surface preparation of the pavement, test the bond strength according to ASTM D4541. The surface is acceptable if the tensile bond strength is greater than or equal to 250 psi, or failure is in the substrate. Repeat cleaning, and testing, if needed, until passing test results are obtained or the surface is acceptable to the engineer.

Keep vehicles and unnecessary equipment off the cleaned surface; only allow HFST application equipment on the clean surface. Apply HFST as soon as possible after pavement surface preparations are completed.

## **C.3 Application of the HFST**

Do not apply the HFST if any of the following exists:

- Pavement surface is wet, damp, or has received rainfall in the previous 24 hours.
- Pavement surface is not sufficiently clean.
- Ambient air or pavement surface temperature is below 50° F or below the manufacturer's recommendations.
- If the anticipated weather conditions would prevent adequate curing of the HFST.
- Rain is predicted before HFST completion or proper cure is achieved.
- Pavement preparation is inadequate or didn't pass pull-off test.

Close treatment areas to traffic until HFST is completely cured and pavement surface has been vacuum-swept.

Construct HFST to the full width of the existing pavement surface, or as the plans show. Extend the HFST application 2'-3' onto the shoulders if application site is on a curve where no rumble strip exists. If the rumble strip exists, apply HFST only on the main lane not on the shoulder.

Apply a primer to the pavement surface if recommended by the resin binder manufacturer, and according to their application recommendations. Abide by the established quality control practices and adhere to any additional manufacturer recommendations for HFST application.

Blend and mix the resin binder components at the manufacturer's specified ratio using equipment capable of providing the desired results.

Apply the resin binder uniformly over the pavement surface manually or with automated equipment at a uniform thickness of 50-65 mils (25-32 ft<sup>2</sup>/gal). Use enough resin to cover the pavement surface and sufficiently embed half the thickness of the aggregate; do not apply so much that it covers the aggregate and creates a slick surface. Adjust application rate, as needed, based on the pavement surface type, profile, and condition.

If using automated equipment, the binder resin system manufacturer shall approve the use of automated continuous application device with their material. Ensure that the equipment features positive displacement, volumetric metering, and can store, mixing, heating, monitoring, and distributing the binder components at the proper mix ratio. Adjust the pressure and the speed of the equipment to achieve the proper application thickness. Coverage rate is based upon expected variance in the surface profile of the pavement.

Do not contaminate the wet binder or allow the binder material to separate or cure and impair bonding of the aggregate.

Immediately after applying the resin binder, distribute a sufficient quantity of dry calcined bauxite aggregate to completely cover the resin binder by hand broadcasting or by using a standard chip spreader or equivalent machine. Ensure aggregate is placed within five minutes of the resin binder placement, before it begins to cure. When broadcasting, sprinkle or drop the aggregate onto the resin binder vertically. Do not distribute aggregate in a way that will cause it to roll in the resin binder before coming to a rest; do not push the aggregate into position with a broom or any other hand tool. If using a chip spreader, the machine shall follow closely behind the crew or equipment applying the resin binder. Immediately cover any visible wet or bare spots, or areas with excessive binder, with additional calcined bauxite aggregate before the resin binder begins to set.

Allow the HFST to properly cure, adhering to manufacturer recommendations for minimum cure times at applicable temperatures.

After the HFST is fully cured, remove excess loose surface aggregate by sweeping, blowing, or vacuuming. Do not tear or otherwise damage the surface. Excess calcined bauxite aggregate that is recovered by a vacuum sweeper can be reused if clean, uncontaminated and dry. Remove and replace damaged areas or areas with excess or insufficient aggregate coverage. Uncover pavement markings and repair damages that occur by covering and uncovering markings. Clean expansion joints, utilities, and drainage structures of all debris before opening to traffic.

Additionally, within 3 to 7 days after opening to traffic, the contractor shall vacuum sweep the pavement surface to remove loosened aggregate from the high friction surface area, the shoulders, and any other areas within and immediately adjacent to the HFST site.

#### **D Measurement**

The department will measure Resin Binder High Friction Surface Treatment by the square yard, acceptably completed.

#### **E Payment**

The department will pay for measured quantities at the contract unit price under the following bid item:

ITEM NUMBER	DESCRIPTION	UNIT
SPV.0180.002	Resin Binder High Friction Surface Treatment	SY

Payment for Resin Binder High Friction Surface Treatment is full compensation for testing materials; for surface preparation; for providing the HFST; for cleanup including uncovering and restoration of pavement markings; and for vacuum sweeping and disposing of excess material after the completion and again 3 to 7 days after completion.

The department will pay for pavement repairs, and traffic control separately under other contract bid items or, absent the appropriate bid items, as extra work.

**130. Micromilling for Base Patching, Item SPV.0180.003.**

**A Description**

This special provision describes the construction of micromilling existing asphaltic pavement surface and concrete base patching within the limits shown on the plans and as directed by the engineer.

**B (Vacant)**

**C Construction**

After concrete base patching operations, micromill the entire base patch area and adjacent existing asphaltic pavement as needed until the engineer considers the micromilled surface satisfactory for traffic operations. Exact limits of the micromilling will be determined by the engineer. Micromilling shall comply with the pertinent requirements of standard spec 204 and 420.3.1 through 420.3.4.

**D Measurement**

The department will measure Micromilling for Base Patching by the square yard of micromilling existing asphaltic pavement and concrete base patching acceptably completed as specified for diamond grinding in 420.4.

**E Payment**

The department will pay for measured quantities at the contract unit price under the following bid item:

ITEM NUMBER	DESCRIPTION	UNIT
SPV.0180.003	Micromilling for Base Patching	SY

Payment is full compensation for micromilling existing asphaltic pavement and concrete base patches; for feathering in adjacent surfaces; for removing unbroken fins; for loading, unloading, and removal of material; and for hauling and off-site disposal of grinding residue.

**131. HMA Longitudinal Joint Repair, Item SPV.0195.001.**

**A Description**

This special provision describes providing longitudinal joint repairs in HMA pavements. Conform to standard spec 204, 315, 455, and 460, and as follows.

**B Materials**

Furnish asphaltic mixture as specified for type 3 HT 58-28 H under standard spec 460.2.

Provide tack coat conforming to standard spec 455.2.5.

**C Construction**

**C.1 General**

Remove an area 1.5 to 3 feet wide and at least to the full depth of asphaltic pavement; the engineer will determine the repair length. Remove damaged concrete pavement discovered below the asphalt during this removal and replace with asphalt mixture.

Clean the existing exposed concrete pavement surface before placing tack coat.

Apply asphaltic materials the same day the joint is removed to prevent the entrance of water. Do not apply if weather or surface conditions are unfavorable or before impending rains.

Conform to standard spec 315.3.1 for placement of the HMA pavement.

Dispose of removed pavement and other waste materials outside of the project limits unless the engineer allows otherwise.

**C.2 Maintenance**

Maintain repaired joints during the contract. Remove and replace additional tack coat and HMA pavement if the engineer directs.

**D Measurement**

The department will measure HMA Longitudinal Joint Repair by the ton, acceptably completed.

## E Payment

The department will pay for measured quantities at the contract unit price under the following bid item:

ITEM NUMBER	DESCRIPTION	UNIT
SPV.0195.001	HMA Longitudinal Joint Repair	TON

Payment for the HMA Longitudinal Joint Repair item is full compensation for providing the joint repair including removing the existing asphaltic surface and damaged concrete; for tack coat and asphaltic pavement mixture; and for maintaining the repair during the contract.

sef-455-005 (20180104)

## 132. Asphaltic Repair, Item SPV.0195.002.

### A Description

This special provision describes repairing areas of existing asphalt pavement with asphaltic mixtures for overlaying with new pavement.

### B Material

Furnish nominal size No. 4 (12.5mm) aggregate blend graded as specified in standard spec 460.2.2.3 and conform to the other material and mixture requirements specified for asphaltic surface in standard spec 465. Use tack coat as required under standard spec 450.3.2.7.

### C Construction

- (1) Remove areas of existing asphalt pavement, including existing patching or surfacing materials, at locations the plans show or the engineer directs in the field as specified for removing asphaltic surface milling in standard spec 204.3.2.2.2. Mill the connecting edges as true and perpendicular as possible, both parallel and perpendicular to the roadway, creating a vertical edge on all sides. Remove the pavement without injury to the remaining pavement. Dispose of removed material as specified in standard spec 204.3.1.3.
- (2) As an option for areas of full depth removal, the contractor may remove areas of existing asphalt pavement, including existing patching or surfacing materials, as specified for removing asphaltic surface in standard spec 204.3.2.2.1. Saw cut the connecting edges as true and perpendicular as possible, as specified for sawing pavement in standard spec 690. Remove the pavement without injury to the remaining pavement. Dispose of removed material as specified in standard spec 204.3.1.3.
- (3) Construct as specified for asphaltic surface under 465.3 except as modified here.

*Replace standard spec 465.3.1(2) with the following:*

- (2) Place using self-propelled pavers. Pave at a constant speed, appropriate for the paver and mixture, that ensures uniform spreading and strike-off with a smooth, dense texture and no tearing or segregation.

*Replace standard spec 465.3.1(3) with the following:*

- (3) Immediately after placement, compact the mixture to produce a dense smooth surface using ordinary compaction procedures as specified in standard spec 450.3.2.6. Unless the engineer directs otherwise, compact each layer to a thickness of 6 inches or less so that the finished surface is 1/16 inch to 1/8 inch above the existing pavement surface.

### D Measurement

The department will measure Asphaltic Repair by the ton, acceptably completed as specified for asphaltic pavement in standard spec 450.4.

### E Payment

- (1) The department will pay for measured quantities at the contract unit price under the following bid item:

ITEM NUMBER	DESCRIPTION	UNIT
SPV.0195.002	Asphaltic Repair	TON

- (2) Payment is full compensation for removing old pavement; for preparing the foundation; and for providing and compacting asphaltic mixture including asphaltic binder. Sawing existing asphalt pavement as a contractor option is incidental to the Asphaltic Repair bid item.
- (3) The department will pay separately for tack coat under the Tack Coat bid item as specified in standard spec 455.5.

SER-390-001 (20220408)

## **ADDITIONAL SPECIAL PROVISION 4**

This special provision does not limit the right of the department, prime contractor, or subcontractors at any tier to withhold payment for work not acceptably completed or work subject to an unresolved contract dispute.

### **Payment to First-Tier Subcontractors**

Within 10 calendar days of receiving a progress payment for work completed by a subcontractor, pay the subcontractor for that work. The prime contractor may withhold payment to a subcontractor if, within 10 calendar days of receipt of that progress payment, the prime contractor provides written notification to the subcontractor and the department documenting "just cause" for withholding payment.

The prime contractor is not allowed to withhold retainage from payments due subcontractors.

### **Payment to Lower-Tier Subcontractors**

Ensure that subcontracting agreements at all tiers provide prompt payment rights to lower-tier subcontractors that parallel those granted first-tier subcontractors in this provision.

### **Acceptance and Final Payment**

Within 30 calendar days of receiving the semi-final estimate from the department, submit written certification that subcontractors at all tiers are paid in full for acceptably completed work.

---

## Additional Special Provision 6 (ASP-6)

### Modifications to the standard specifications

*Make the following revisions to the standard specifications:*

---

#### 108 Prosecution and Progress

*Add subsection 108.9.4.1 effective with the November 2023 letting:*

##### 108.9.4.1 Winter Suspension for Completion Date Contracts

- (1) The contractor may request a winter suspension for a completion date contract. If the department determines weather conditions do not allow for the completion of the remaining work, the department may approve the contractor's request and determine the start date of the winter suspension. The end date of the winter suspension is March 31 or a date mutually agreed upon by both parties. For multi-year contracts, the department will only consider winter suspension for the final year of the contract.
  - (2) During winter suspension, store all materials in a manner that does not obstruct vehicular and pedestrian traffic and protect the materials from damage. Install traffic control and other safety devices necessary to protect the traveling public and pedestrians. Provide suitable drainage and install temporary erosion control where necessary. If the winter suspension begins when liquidated damages are being assessed, or when the work has not progressed as scheduled and would not have been completed prior to the completion date, the cost of necessary pre-suspension work is incidental. If the winter suspension begins prior to the contract completion date, and the work has progressed as scheduled and would have been completed prior to the completion date, the cost of pre-suspension work will be paid as specified under 109.4.
  - (3) For a winter suspension that begins prior to the contract completion date and the work has progressed as scheduled and would have been completed prior to the completion date, the engineer will extend contract time to correspond with the end of the winter suspension and liquidated damages will not be assessed during the winter suspension.
  - (4) For a winter suspension that begins when liquidated damages are being assessed or when the work has not progressed as scheduled and would not have been completed prior to the completion date, the engineer will not extend contract time. Time will be suspended until the end of the winter suspension. Liquidated damages will not be assessed during the winter suspension and liquidated damages will resume at the end of the winter suspension.
- 

#### 108.10.2 Excusable, Non-Compensable Delays

##### 108.10.2.1 General

*Replace entire section with the following effective with the January 2024 letting:*

- (1) Non-compensable delays, 108.10.2.1(3), are excusable delays not the contractor's or the department's fault. The engineer will not pay for the delay costs listed in 109.4.7 for non-compensable delays.
  - (2) For non-compensable delays under calendar day and completion date contracts, the engineer will extend contract time if the conditions specified in 108.10.1 are met. The department will relieve the contractor from associated liquidated damages, as specified in 108.11, if the engineer extends time under 108.10.1.
  - (3) The following are non-compensable delays:
    1. Delays due to earthquakes, other cataclysmic phenomena of nature the contractor cannot foresee and avoid, severe weather or job conditions caused by recent weather as specified in 108.10.2.2.
    2. Extraordinary delays in material deliveries the contractor or their suppliers cannot foresee and forestall resulting from strikes, lockouts, freight embargoes, industry-wide shortages, governmental acts, or sudden disasters.
    3. Delays due to acts of the government, a political subdivision other than the department, or the public enemy.
    4. Delays from fires or epidemics.
    5. Delays from strikes beyond the contractor's power to settle not caused by improper acts or omissions of the contractor, their subcontractors, or their suppliers.
    6. Altered quantities as specified in 109.3.
- 

#### 108.10.3 Excusable Compensable Delays

*Replace entire section with the following effective with the January 2024 letting:*

- (1) Compensable delays are excusable delays due to the department's actions or lack of actions. The engineer will grant a time extension for a compensable delay if the conditions specified in 108.10.1 are met.
- (2) The following are compensable delays:



1. A contract change for revised work as specified for extra work under 104.2.2.1, for a differing site condition under 104.2.2.2, or for significant changes in the character of the work under 104.2.2.4.
  2. A contract change for an engineer-ordered suspension under 104.2.2.3.
  3. The unexpected discovery of human remains, an archaeological find, or historical find consistent with 107.25.
  4. The unexpected discovery of a hazardous substance consistent with 107.24.
  5. The non-completion of work that utilities or other third parties perform, if that work is not completed as specified in the contract.
- (3) For a compensable delay or a time extension, the department will relieve the contractor from associated liquidated damages under 108.11, and will pay the contractor for delay costs determined as follows:
1. Adjust the contract price as specified in 109.4.2 through 109.4.5 for delays under item 1 of 108.10.3(2).
  2. Adjust the contract price as specified in 109.4.7 for delays under items 2 through 5 of 108.10.3(2).

**310 Open Graded Base**

**310.2 Materials**

Replace paragraph two with the following effective with the November 2023 letting:

- (2) The contractor may substitute material conforming to the gradation requirements for crushed aggregate specified in Table 310-01 if that material conforms to the fracture requirements for open-graded crushed gravel specified in 301.2.4.5.

**TABLE 310-01 COARSE AGGREGATE (% passing by weight)**

AASHTO No. 67 <sup>[1]</sup>	
SEIVE	COARSE AGGREGATE (% PASSING by WEIGHT) AASHTO No. 67
2-inch	-
1 1/2-inch	-
1-inch	100
3/4-inch	90 – 100
1/2-inch	-
3/8-inch	20 – 55
No. 4	0 – 10
No. 8	0 – 5
No. 16	-
No. 30	-
No. 50	-
No. 100	-
No. 200	<=1.5

[1] Size according to AASHTO M43.

**390 Base Patching**

**390.4 Measurement**

Replace entire section with the following effective with the November 2023 letting:

- (1) The department will measure Removing Pavement for Base Patching by the cubic yard acceptably completed. Measure the depth from the bottom of the adjacent pavement to the top of the patch.
- (2) The department will measure Base Patching Asphaltic by the ton acceptably completed as specified for asphaltic pavement in 450.4.
- (3) The department will measure Base Patching Concrete HES and Base Patching Concrete SHES by the cubic yard acceptably completed. Measure the depth from the bottom of the adjacent pavement to the top of the patch.

**390.5 Payment**

Replace entire section with the following effective with the November 2023 letting:

- (1) The department will pay for measured quantities at the contract unit price under the following bid items:

<u>ITEM NUMBER</u>	<u>DESCRIPTION</u>	<u>UNIT</u>
390.0100	Removing Pavement for Base Patching	CY
390.0201	Base Patching Asphaltic	TON
390.0305	Base Patching Concrete HES	CY
390.0405	Base Patching Concrete SHES	CY

- (2) Payment for Removing Pavement for Base Patching is full compensation for removing old pavement; for preparing the foundation and bringing up to grade. If the engineer orders the contractor to excavate yielding or unstable subgrade materials and backfill with suitable materials, the department will pay for that work with contract bid items or as agreed upon using 109.4.
- (3) Payment for Base Patching Asphaltic is full compensation for providing and compacting asphaltic mixture including asphaltic binder.
- (4) Payment for Base Patching Concrete HES and Base Patching Concrete SHES is full compensation for providing, curing, and protecting concrete. Payment also includes providing tie bars and dowel bars in unhardened concrete and steel within the patch. For tie bars and dowel bars provided in concrete not placed under the contract, the department will pay separately under the Drilled Tie Bars and Drilled Dowel Bars bid items as specified in 416.5.
- (5) Payment for Base Patching SHES also includes providing test data to the engineer as specified in 416.2.4.
- (6) The department will pay for sawing existing concrete pavement for removal under the Sawing Concrete bid item as specified in 690.5.

**460 Hot Mix Asphalt Pavement****460.2.8.2.1.3.1 Contracts with 5000 Tons of Mixture or Greater**

Replace paragraph four with the following effective with the November 2023 letting:

- (4) Use the test methods identified below, or other methods the engineer approves, to perform the following tests at the frequency indicated:

Blended aggregate gradations:

Drum plants:

- Field extraction by ignition oven according to WTM T308, chemical extraction according to AASHTO T-164 method A or B; or automated extraction according to WTM D8159. Gradation of resulting aggregate sample determined according to WTM T30.
- Belt samples, optional for virgin mixtures, obtained from stopped belt or from the belt discharge using an engineer-approved sampling device and performed according to WTM T11 and T27.

Batch plants:

- Field extraction by ignition oven according to WTM T308, chemical extraction according to AASHTO T-164 method A or B; or automated extraction according to WTM D8159. Gradation of resulting aggregate sample determined according to WTM T30.

Asphalt content (AC) in percent:

Determine AC using one of the following methods:

- AC by ignition oven according to WTM T308.
- AC by chemical extraction according to AASHTO T-164 method A or B.
- AC by automated extraction according to WTM D8159.
- If the department is using an ignition oven to determine AC, conform to WTP H003.
- If the department is not using an ignition oven to determine AC, ignition oven correction factor (IOCF) must still be reverified for any of the reasons listed in WTP H003 Table 2 and conform to WTP H-003 sections 3 through 6.
- Gradation of resulting aggregate sample determined according to WTM T30.

Bulk specific gravity of the compacted mixture:

According to WTM T166.

Theoretical maximum specific gravity:

According to WTM T209.

Air voids (Va) by calculation according to WTM T269.

---

VMA by calculation according to WTM R35.

#### 460.2.8.3.1.4 Department Verification Testing Requirements

Replace paragraph three with the following effective with the November 2023 letting:

- (3) The department will perform testing conforming to the following standards:
  - Bulk specific gravity ( $G_{mb}$ ) of the compacted mixture according to WTM T166.
  - Maximum specific gravity ( $G_{mm}$ ) according to WTM T209.
  - Air voids ( $V_a$ ) by calculation according to WTM T269.
  - VMA by calculation according to WTM R35.
  - Asphalt content by ignition oven according to WTM T308, chemical extraction according to AASHTO T-164 method A or B, or automated extraction according to WTM D8159. If using an ignition oven to determine AC, conform to WTP H-003.

#### 460.3.3.2 Pavement Density Determinations

Replace entire section with the following effective with the February 2024 letting:

- (1) The engineer will determine the target maximum density using department procedures described in WTM T355. The engineer will determine density according to CMM 815 and WTM T355 as soon as practicable after compaction and before placement of subsequent layers or before opening to traffic.
- (2) Do not re-roll compacted mixtures with deficient density test results. Do not operate continuously below the specified minimum density. Stop production, identify the source of the problem, and make corrections to produce work meeting the specification requirements.
- (3) A lot is defined as one day's production for each subplot type or one production shift if running 24 hours per day and placed within a single layer for each location and target maximum density category indicated in table 460-3. The lot density is the average of the tests taken for that lot. The department determines the number of tests per lot according to WTP H-002.
- (4) An HTCP-certified Nuclear Density Technician I (NUCDENSITYTEC-I) or a nuclear density ACT working under a NUCDENSITYTEC-I technician, will locate samples and perform the testing. A NUCDENSITYTEC-I technician will coordinate and take responsibility for the work an ACT performs. No more than one ACT can work under a single NUCDENSITYTEC-I technician. The responsible NUCDENSITYTEC-I technician will ensure that sample location and testing is performed correctly, analyze test results, and provide density results to the contractor weekly.

---

### 503 Prestressed Concrete Members

#### 503.2.2 Concrete

Replace paragraph five with the following effective with the November 2023 letting:

- (5) Furnish prestressed concrete members cast from air-entrained concrete, except I-type girders may use non-air-entrained concrete. Use type I, IL, IS, IP, IT, II, or III cement. The contractor may replace up to 30 percent of type I, IL, II, or III cement with an equal weight of fly ash, slag, or a combination of fly ash and slag. Ensure that fly ash conforms to 501.2.4.2.2 and slag conforms to 501.2.4.2.3. Use only one source and replacement rate for work under a single bid item. Use a department-approved air-entraining admixture conforming to 501.2.5.2 for air-entrained concrete. Use only coarse aggregate conforming to 310.2(2).

---

### 604 Slope Paving

#### 604.2 Materials

Replace paragraph three with the following effective with the November 2023 letting:

- (3) Under the Slope Paving Crushed Aggregate bid item, furnish crushed stone or crushed gravel conforming to the gradation in Table 604-01, but with the additional requirements that at least 75 percent of the particles, by count, have at least one fractured face. Determine fracture according to WTM D5821.

**TABLE 604-01 COARSE AGGREGATE (% passing by weight)**

<b>AASHTO No. 4<sup>[1]</sup></b>	
SEIVE	COARSE AGGREGATE (% PASSING by WEIGHT) AASHTO No. 4
2-inch	100
1 1/2-inch	90 - 100
1-inch	20 - 55
3/4-inch	0 - 15
1/2-inch	-
3/8-inch	0 - 5
No. 4	-
No. 8	-
No. 16	-
No. 30	-
No. 50	-
No. 100	-
No. 200	<=1.5

<sup>[1]</sup> Size according to AASHTO M43.

**612 Underdrains**

**612.3.9 Trench Underdrains**

*Replace paragraph one with the following effective with the November 2023 letting:*

- (1) Under the Underdrain Trench bid item, excavate and backfill underdrain trenches. Backfill with coarse aggregate gradation conforming to 604.2(3). Before backfilling place geotextile as the plans show.

**614 Semi-rigid Barrier Systems and End Treatments**

**614.2.6 Sand Barrel Arrays**

*Replace paragraph one with the following effective with the November 2023 letting:*

- (1) Furnish sand barrels from the APL. Use fine aggregate conforming to gradation shown in Table 614-2 mixed with sodium chloride conforming to AASHTO M143. Apply an object marker to front-most barrel in the array.

**TABLE 614-2 FINE AGGREGATE GRADATION**

SEIVE	FINE AGGREGATE (% PASSING by WEIGHT)
3/8-inch	100
No. 4	90 - 100
No. 8	-
No. 16	45 - 85
No. 30	-
No. 50	5 - 30
No. 100	0 - 10
No. 200	<=3.5

**628 Erosion Control****628.2.13 Rock Bags**

*Replace paragraph two with the following effective with the November 2023 letting:*

- (2) Fill the bags with a clean, sound, hard, durable, engineer-approved coarse aggregate conforming by visual inspection to the gradation specified for coarse aggregate gradation in 604.2(3).

**639 Drilling Wells****639.2.1 General**

*Replace paragraph two with the following effective with the November 2023 letting:*

- (2) For grout use fine aggregate conforming to 501.2.7.2; and gradation conforming to 614.2.6(1); and type I, IL, IS, IP, or IT cement.

**652 Electrical Conduit****652.3.1.2 Installing Underground**

*Replace paragraph two with the following effective with the November 2023 letting:*

- (2) Excavate trenches true to line and grade to provide the conduit uniform bearing throughout its length. Do not backfill the trench before inspecting the conduit. Carefully tamp the backfill in place as specified for placing backfill in layers in 651.3. Place at least 0.7 cubic feet of coarse aggregate gradation conforming to 604.2(3) directly under each drainage hole.

---

**ERRATA**

---

**390.3.4 Special High Early Strength Concrete Patching**

*Correct errata link in paragraph (1) by changing from 416.3.8 to 416.3.7.*

- (1) Construct as specified for special high early strength repairs under 416.3.7 except as follows:
  - The contractor may delay removal for up to 14 calendar days after cutting the existing pavement.
  - Open to traffic as specified for concrete base in 320.3.

## ADDITIONAL SPECIAL PROVISION 7

### A. Reporting 1<sup>st</sup> Tier and DBE Payments During Construction

1. Comply with reporting requirements specified in the department's Civil Rights Compliance, Contractor's User Manual, Sublets and Payments.
2. Report payments to all DBE firms within 10 calendar days of receipt of a progress payment by the department or a contractor for work performed, materials furnished, or materials stockpiled by a DBE firm. Report the payment as specified in A(1) for all work satisfactorily performed and for all materials furnished or stockpiled.
3. Report payments to all first tier subcontractor relationships within 10 calendar days of receipt of a progress payment by the department for work performed. Report the payment as specified in A(1) for all work satisfactorily performed.
4. All tiers shall report payments as necessary to comply with the DBE payment requirement as specified in A(2).
5. DBE firms must enter all payments to DBE and non-DBE firms regardless of tier.
6. Require all first tier relationships, DBE firms and all other tier relationships necessary to comply with the DBE payment requirement in receipt of a progress payment by contractor to acknowledge receipt of payment as specified in A(1), (2), (3) and (4).
7. All agreements made by a contractor shall include the provisions in A(1), (2), (3), (4), (5), and (6), and shall be binding on all first tier subcontractor relationships, all contractors and subcontractors utilizing DBE firms on the project, and all payments from DBE firms.

### B. Costs for conforming to this special provision are incidental to the contract.

NOTE: CRCS Prime Contractor payment is currently not automated and will need to be manually loaded into the Civil Rights Compliance System. Copies of prime contractor payments received (check or ACH) will have to be forwarded to [paul.ndon@dot.wi.gov](mailto:paul.ndon@dot.wi.gov) within 5 days of payment receipt to be logged manually.

\*\*\*Additionally, for information on Subcontractor Sublet assignments, Subcontractor Payments and Payment Tracking, please refer to the CRCS Payment and Sublets manual at:

<https://wisconsindot.gov/Documents/doing-bus/civil-rights/labornwage/crcs-payments-sublets-manual.pdf>

## **ADDITIONAL SPECIAL PROVISION 9**

### **Electronic Certified Payroll or Labor Data Submittal**

- (1) Use the department's Civil Rights Compliance System (CRCS) to electronically submit certified payroll reports for contracts with federal funds and labor data for contracts with state funds only. Details are available online through the department's highway construction contractor information (HCCI) site on the Labor, Wages, and EEO Information page at:  
<https://wisconsindot.gov/Pages/doing-bus/civil-rights/labornwage/default.aspx>
- (2) Ensure that all tiers of subcontractors, including all trucking firms, either submit their weekly certified payroll reports (contracts with federal funds) or labor data (contracts with state funds only) electronically through CRCS. These payrolls or labor data are due within seven calendar days following the close of the payroll period. Every firm providing physical labor towards completing the project is a subcontractor under this special provision.
- (3) Upon receipt of contract execution, promptly make all affected firms aware of the requirements under this special provision and arrange for them to receive CRCS training as they are about to begin their submittals. The department will provide training either in a classroom setting at one of our regional offices or by telephone. Contact Paul Ndon at (414) 438-4584 to schedule the training.
- (4) The department will reject all paper submittals for information required under this special provision. All costs for conforming to this special provision are incidental to the contract.
- (5) Firms wishing to export payroll/labor data from their computer system into CRCS should have their payroll coordinator contact Paul Ndon at [paul.ndon@dot.wi.gov](mailto:paul.ndon@dot.wi.gov). Not every contractor's payroll system is capable of producing export files. For details, see Section 4.8 CPR Auto Submit (Data Mapping) on pages 49-50; 66-71 of the CRCS Payroll Manual at:  
<https://wisconsindot.gov/Documents/doing-bus/civil-rights/labornwage/crcs-payroll-manual.pdf>

## NON-DISCRIMINATION PROVISIONS

**During the performance of this contract, the contractor, for itself, its assignees, and successors in interest (hereinafter referred to as the "contractor") agrees as follows:**

**1. Compliance with Regulations:** The contractor (hereinafter includes consultants) will comply with the Acts and the Regulations relative to Non-discrimination in Federally-assisted programs of the U.S. Department of Transportation, Federal Highway Administration, as they may be amended from time to time, which are herein incorporated by reference and made a part of this contract.

**2. Non-discrimination:** The contractor, with regard to the work performed by it during the contract, will not discriminate on the grounds of race, color, or national origin in the selection and retention of subcontractors, including procurements of materials and leases of equipment. The contractor will not participate directly or indirectly in the discrimination prohibited by the Acts and the Regulations, including employment practices when the contract covers any activity, project, or program set forth in Appendix B of 49 CFR Part 21.

**3. Solicitations for Subcontracts, Including Procurements of Materials and Equipment:** In all solicitations, either by competitive bidding, or negotiation made by the contractor for work to be performed under a subcontract, including procurements of materials, or leases of equipment, each potential subcontractor or supplier will be notified by the contractor of the contractor's obligations under this contract and the Acts and the Regulations relative to Non-discrimination on the grounds of race, color, or national origin.

**4. Information and Reports:** The contractor will provide all information and reports required by the Acts, the Regulations, and directives issued pursuant thereto and will permit access to its books, records, accounts, other sources of information, and its facilities as may be determined by the Recipient or the Federal Highway Administration to be pertinent to ascertain compliance with such Acts, Regulations, and instructions. Where any information required of a contractor is in the exclusive possession of another who fails or refuses to furnish the information, the contractor will so certify to the Recipient or the Federal Highway Administration, as appropriate, and will set forth what efforts it has made to obtain the information.

**5. Sanctions for Noncompliance:** In the event of a contractor's noncompliance with the Non-discrimination provisions of this contract, the Recipient will impose such contract sanctions as it or the Federal Highway Administration may determine to be appropriate, including, but not limited to:

- a. Withholding payments to the contractor under the contract until the contractor complies; and/or
- b. Cancelling, terminating, or suspending a contract, in whole or in part.

**6. Incorporation of Provisions:** The contractor will include the provisions of paragraphs one through six in every subcontract, including procurements of materials and leases of equipment, unless exempt by the Acts, the Regulations and directives issued pursuant thereto. The contractor will take action with respect to any subcontract or procurement as the Recipient or the Federal Highway Administration may direct as a means of enforcing such provisions including sanctions for noncompliance. Provided, that if the contractor becomes involved in, or is threatened with litigation by a subcontractor, or supplier because of such direction, the contractor may request the Recipient to enter into any litigation to protect the interests of the Recipient. In addition, the contractor may request the United States to enter into the litigation to protect the interests of the United States.



**During the performance of this contract, the contractor, for itself, its assignees, and successors in interest (hereinafter referred to as the "contractor") agrees to comply with the following non-discrimination statutes and authorities; including but not limited to:**

**Pertinent Non-Discrimination Authorities:**

- Title VI of the Civil Rights Act of 1964 (42 U.S.C. § 2000d et seq., 78 stat. 252), (prohibits discrimination on the basis of race, color, national origin); and 49 CFR Part 21.
- The Uniform Relocation Assistance and Real Property Acquisition Policies Act of 1970, (42 U.S.C. § 4601), (prohibits unfair treatment of persons displaced or whose property has been acquired because of Federal or Federal-aid programs and projects);
- Federal-Aid Highway Act of 1973, (23 U.S.C. § 324 et seq.), (prohibits discrimination on the basis of sex);
- Section 504 of the Rehabilitation Act of 1973, (29 U.S.C. § 794 et seq.), as amended, (prohibits discrimination on the basis of disability); and 49 CFR Part 27;
- The Age Discrimination Act of 1975, as amended, (42 U.S.C. § 6101 et seq.), (prohibits discrimination on the basis of age);
- Airport and Airway Improvement Act of 1982, (49 USC § 471, Section 47123), as amended, (prohibits discrimination based on race, creed, color, national origin, or sex);
- The Civil Rights Restoration Act of 1987, (PL 100-209), (Broadened the scope, coverage and applicability of Title VI of the Civil Rights Act of 1964, The Age Discrimination Act of 1975 and Section 504 of the Rehabilitation Act of 1973, by expanding the definition of the terms "programs or activities" to include all of the programs or activities of the Federal-aid recipients, sub-recipients and contractors, whether such programs or activities are Federally funded or not);
- Titles II and III of the Americans with Disabilities Act, which prohibit discrimination on the basis of disability in the operation of public entities, public and private transportation systems, places of public accommodation, and certain testing entities (42 U.S.C. §§ 12131-12189) as implemented by Department of Transportation regulations at 49 C.F.R. parts 37 and 38;
- The Federal Aviation Administration's Non-discrimination statute (49 U.S.C. § 47123) (prohibits discrimination on the basis of race, color, national origin, and sex);
- Executive Order 12898, Federal Actions to Address Environmental Justice in Minority Populations and Low-Income Populations, which ensures Non-discrimination against minority populations by discouraging programs, policies, and activities with disproportionately high and adverse human health or environmental effects on minority and low-income populations;
- Executive Order 13166, Improving Access to Services for Persons with Limited English Proficiency, and resulting agency guidance, national origin discrimination includes discrimination because of Limited English proficiency (LEP). To ensure compliance with Title VI, you must take reasonable steps to ensure that LEP persons have meaningful access to your programs (70 Fed. Reg. at 74087 to 74100);
- Title IX of the Education Amendments of 1972, as amended, which prohibits you from discriminating because of sex in education programs or activities (20 U.S.C. 1681 et seq).

## BUY AMERICA PROVISION

Buy America (as documented in [88 FR 57750 \(2 CFR part 184 and 200\)](#) from the Office of Management and Budget: [Federal Register: Guidance for Grants and Agreements](#) ) shall be domestic products and permanently incorporated in this project as classified in the following three categories, and as noted in the Construction and Materials Manual (CMM):

### 1. Iron and Steel

All iron and steel manufacturing and coating processes (from the initial melting stage through the application of coatings) must have occurred within the United States. Coating includes epoxy coating, galvanizing, painting and any other coating that protects or enhances the value of a material subject to the requirements of Buy America.

The exemption of the iron and steel manufacturing and coating processes Buy America requirement is the minimal use of foreign materials if the total cost of such material permanently incorporated in the product does not exceed one-tenth of one percent (1/10 of 1%) of the total contract cost or \$2,500.00, whichever is greater. For purposes of this paragraph, the cost is that shown to be the value of the subject products as they are delivered to the project.

### 2. Manufactured Product

All manufactured products (as defined in CMM 228.5) are covered under a previous waiver from 1983 and are currently exempt from Buy America.

### 3. Construction Material

All construction materials (as defined in [88 FR 57750 \(2 CFR part 184 and 200\)](#) and as referenced in CMM 228.5) must comply with Buy America. All manufacturing process of construction materials must occur in the United States.

[88 FR 55817 \(DOT-OST-2022-0124\)](#) allows a limited waiver of Buy America requirements for de minimis costs and small grants.

- The Total value of the non-compliant products is no more than the lesser of \$1,000,000 or 5% of total applicable costs for the project<sup>1</sup>; or
- The total amount of Federal financial assistance applied to the project, through awards or subaward, is below \$500,000<sup>2</sup>

The contractor shall take actions and provide documentation conforming to CMM 228.5 to ensure compliance with this Buy America provision.

<https://wisconsin.gov/rdwy/cmm/cm-02-28.pdf>

Upon completion of the project, certify to the engineer, in writing using department form DT4567 that all iron and steel, manufactured products, and construction materials conform to this Buy America provision.

Form DT4567 is available at: <https://wisconsin.gov/Documents/formdocs/dt4567.docx>

Attach a list of iron or steel and construction material exemptions and their associated costs to the certification form.

---

<sup>1</sup> The de minimis public interest waiver does not apply to iron and steel subject to the requirements of 23 U.S.C. 313 on financial assistance administered by FHWA. The de minimis threshold in 23 CFR 635.410(b)(4) continues to apply for iron and steel.

<sup>2</sup> The small grant portion of the waiver does not apply to iron, steel, and manufactured goods subject to the requirements of 49 U.S.C. 22905(a).



Proposal Schedule of Items

Proposal ID: 20240409007 Project(s): 1060-10-71, 1060-47-70, 1330-47-71, 2788-03-70

Federal ID(s): N/A, N/A, N/A, N/A

SECTION: 0001 Contract Items

Alt Set ID: Alt Mbr ID:

Proposal Line Number	Item ID Description	Approximate Quantity and Units	Unit Price	Bid Amount
0002	201.0105 Clearing	9.000 STA	_____.	_____.
0004	201.0120 Clearing	50.000 ID	_____.	_____.
0006	201.0205 Grubbing	9.000 STA	_____.	_____.
0008	201.0220 Grubbing	50.000 ID	_____.	_____.
0010	203.0100 Removing Small Pipe Culverts	6.000 EACH	_____.	_____.
0012	203.0220 Removing Structure (structure) 001. C-67-25	1.000 EACH	_____.	_____.
0014	203.0220 Removing Structure (structure) 002. C-67-865	1.000 EACH	_____.	_____.
0016	203.0220 Removing Structure (structure) 003. R-67-49	1.000 EACH	_____.	_____.
0018	203.0220 Removing Structure (structure) 004. B-67-245	1.000 EACH	_____.	_____.
0020	204.0100 Removing Concrete Pavement	945.000 SY	_____.	_____.
0022	204.0109.S Removing Concrete Surface Partial Depth	101,248.000 SF	_____.	_____.
0024	204.0110 Removing Asphaltic Surface	10,165.000 SY	_____.	_____.
0026	204.0115 Removing Asphaltic Surface Butt Joints	4,783.000 SY	_____.	_____.
0028	204.0120 Removing Asphaltic Surface Milling	492,497.000 SY	_____.	_____.
0030	204.0126.S Removing Asphaltic Longitudinal Notched Wedge Joint Milling	70,112.000 LF	_____.	_____.



Proposal Schedule of Items

Proposal ID: 20240409007 Project(s): 1060-10-71, 1060-47-70, 1330-47-71, 2788-03-70

Federal ID(s): N/A, N/A, N/A, N/A

SECTION: 0001 Contract Items

Alt Set ID: Alt Mbr ID:

Proposal Line Number	Item ID Description	Approximate Quantity and Units	Unit Price	Bid Amount
0032	204.0130 Removing Curb	384.000 LF	_____.	_____.
0034	204.0150 Removing Curb & Gutter	2,992.000 LF	_____.	_____.
0036	204.0155 Removing Concrete Sidewalk	337.000 SY	_____.	_____.
0038	204.0157 Removing Concrete Barrier	970.000 LF	_____.	_____.
0040	204.0165 Removing Guardrail	12,690.000 LF	_____.	_____.
0042	204.0170 Removing Fence	2,504.000 LF	_____.	_____.
0044	204.0195 Removing Concrete Bases	56.000 EACH	_____.	_____.
0046	204.0210 Removing Manholes	1.000 EACH	_____.	_____.
0048	204.0220 Removing Inlets	7.000 EACH	_____.	_____.
0050	204.0245 Removing Storm Sewer (size) 001. 12-Inch	39.000 LF	_____.	_____.
0052	204.0245 Removing Storm Sewer (size) 002. 24-Inch	32.000 LF	_____.	_____.
0054	204.0246 Removing Ancillary Structure (structure) 001. S-67-215	1.000 EACH	_____.	_____.
0056	204.0246 Removing Ancillary Structure (structure) 002. S-67-216	1.000 EACH	_____.	_____.
0058	204.0270 Abandoning Culvert Pipes	4.000 EACH	_____.	_____.
0060	204.9060.S Removing (item description) 001. Crash Cushion	2.000 EACH	_____.	_____.



Proposal Schedule of Items

Proposal ID: 20240409007 Project(s): 1060-10-71, 1060-47-70, 1330-47-71, 2788-03-70

Federal ID(s): N/A, N/A, N/A, N/A

SECTION: 0001 Contract Items

Alt Set ID: Alt Mbr ID:

Proposal Line Number	Item ID Description	Approximate Quantity and Units	Unit Price	Bid Amount
0062	204.9060.S Removing (item description) 002. Bicycle Rack	1.000 EACH	_____.	_____.
0064	204.9060.S Removing (item description) 003. Existing Ramp Gate Assembly	1.000 EACH	_____.	_____.
0066	204.9060.S Removing (item description) 021. Traffic Signals IH 94 EB Ramps & CTH SS	1.000 EACH	_____.	_____.
0068	204.9060.S Removing (item description) 041. Removing Traffic Signals STH 318 & Silvernail Rd.	1.000 EACH	_____.	_____.
0070	204.9060.S Removing (item description) 042. Removing Loop Detector Wire & Lead-in Cable STH 318 & Silvernail Rd.	1.000 EACH	_____.	_____.
0072	204.9060.S Removing (item description) 051. Traffic Signals IH 94 EB Ramps & STH 318	1.000 EACH	_____.	_____.
0074	204.9060.S Removing (item description) 052. Loop Detector Wire and Lead In Cable IH 94 EB Ramps & STH 318	1.000 EACH	_____.	_____.
0076	204.9060.S Removing (item description) 061. Traffic Signals IH 94 WB Ramps & STH 318	1.000 EACH	_____.	_____.
0078	204.9060.S Removing (item description) 062. Loop Detector Wire and Lead In Cable IH 94 WB Ramps & STH 318	1.000 EACH	_____.	_____.
0080	204.9060.S Removing (item description) 071. Traffic Signals IH 94 EB Ramps & CTH T	1.000 EACH	_____.	_____.
0082	204.9060.S Removing (item description) 072. Loop Detector Wire and Lead In Cable IH 94 EB Ramps & CTH T	1.000 EACH	_____.	_____.
0084	204.9060.S Removing (item description) 081. Traffic Signals IH 94 WB Ramps & CTH T	1.000 EACH	_____.	_____.



Proposal Schedule of Items

Proposal ID: 20240409007 Project(s): 1060-10-71, 1060-47-70, 1330-47-71, 2788-03-70

Federal ID(s): N/A, N/A, N/A, N/A

SECTION: 0001 Contract Items

Alt Set ID: Alt Mbr ID:

Proposal Line Number	Item ID Description	Approximate Quantity and Units	Unit Price	Bid Amount
0086	204.9060.S Removing (item description) 082. Loop Detector Wire and Lead In Cable IH 94 WB Ramps & CTH T	1.000 EACH	_____.	_____.
0088	204.9060.S Removing (item description) 401. Lighting Units	5.000 EACH	_____.	_____.
0090	204.9060.S Removing (item description) 402. Luminaires	12.000 EACH	_____.	_____.
0092	204.9090.S Removing (item description) 001. Cable Barrier	2,348.000 LF	_____.	_____.
0094	205.0100 Excavation Common	2,960.000 CY	_____.	_____.
0096	206.1001 Excavation for Structures Bridges (structure) 001. B-67-245	1.000 EACH	_____.	_____.
0098	206.2001 Excavation for Structures Culverts (structure) 001. C-67-25	1.000 EACH	_____.	_____.
0100	208.0100 Borrow	2,469.000 CY	_____.	_____.
0102	209.1100 Backfill Granular Grade 1	476.000 CY	_____.	_____.
0104	210.1500 Backfill Structure Type A	464.000 TON	_____.	_____.
0106	210.2500 Backfill Structure Type B	38.000 TON	_____.	_____.
0108	211.0101 Prepare Foundation for Asphaltic Paving (project) 001. 1060-47-70	0.880 EACH	_____.	_____.
0110	211.0101 Prepare Foundation for Asphaltic Paving (project) 002. 1330-47-71	0.010 EACH	_____.	_____.
0112	211.0101 Prepare Foundation for Asphaltic Paving (project) 003. 2788-03-70	0.020 EACH	_____.	_____.



Proposal Schedule of Items

Proposal ID: 20240409007 Project(s): 1060-10-71, 1060-47-70, 1330-47-71, 2788-03-70

Federal ID(s): N/A, N/A, N/A, N/A

SECTION: 0001 Contract Items

Alt Set ID: Alt Mbr ID:

Proposal Line Number	Item ID Description	Approximate Quantity and Units	Unit Price	Bid Amount
0114	211.0101 Prepare Foundation for Asphaltic Paving (project) 004. 1060-10-71	0.090 EACH	_____.	_____.
0116	213.0100 Finishing Roadway (project) 001. 1060-47-70	1.000 EACH	_____.	_____.
0118	213.0100 Finishing Roadway (project) 002. 1330-47-71	1.000 EACH	_____.	_____.
0120	213.0100 Finishing Roadway (project) 003. 2788-03-70	1.000 EACH	_____.	_____.
0122	213.0100 Finishing Roadway (project) 004. 1060-10-71	1.000 EACH	_____.	_____.
0124	305.0110 Base Aggregate Dense 3/4-Inch	2,683.000 TON	_____.	_____.
0126	305.0120 Base Aggregate Dense 1 1/4-Inch	1,596.000 TON	_____.	_____.
0128	390.0100 Removing Pavement for Base Patching	4,162.000 CY	_____.	_____.
0130	390.0405 Base Patching Concrete SHES	4,162.000 CY	_____.	_____.
0132	415.0070 Concrete Pavement 7-Inch	100.000 SY	_____.	_____.
0134	415.0080 Concrete Pavement 8-Inch	107.000 SY	_____.	_____.
0136	415.0090 Concrete Pavement 9-Inch	371.000 SY	_____.	_____.
0138	415.0410 Concrete Pavement Approach Slab	507.000 SY	_____.	_____.
0140	416.0610 Drilled Tie Bars	669.000 EACH	_____.	_____.
0142	416.0620 Drilled Dowel Bars	21,530.000 EACH	_____.	_____.



Proposal Schedule of Items

Proposal ID: 20240409007 Project(s): 1060-10-71, 1060-47-70, 1330-47-71, 2788-03-70

Federal ID(s): N/A, N/A, N/A, N/A

SECTION: 0001 Contract Items

Alt Set ID: Alt Mbr ID:

Proposal Line Number	Item ID Description	Approximate Quantity and Units	Unit Price	Bid Amount
0144	416.1710 Concrete Pavement Repair	92.000 SY	_____.	_____.
0146	416.1715 Concrete Pavement Repair SHES	824.000 SY	_____.	_____.
0148	416.1720 Concrete Pavement Replacement	430.000 SY	_____.	_____.
0150	416.1725 Concrete Pavement Replacement SHES	589.000 SY	_____.	_____.
0152	455.0605 Tack Coat	45,907.000 GAL	_____.	_____.
0154	460.0105.S HMA Percent Within Limits (PWL) Test Strip Volumetrics	1.000 EACH	_____.	_____.
0156	460.0110.S HMA Percent Within Limits (PWL) Test Strip Density	2.000 EACH	_____.	_____.
0158	460.0115.S HMA Pavement Test Strip Volumetrics	1.000 EACH	_____.	_____.
0160	460.0120.S HMA Pavement Test Strip Density	3.000 EACH	_____.	_____.
0162	460.2000 Incentive Density HMA Pavement	35,576.000 DOL	1.00000	35,576.00
0164	460.2005 Incentive Density PWL HMA Pavement	34,580.000 DOL	1.00000	34,580.00
0166	460.2007 Incentive Density HMA Pavement Longitudinal Joints	17,800.000 DOL	1.00000	17,800.00
0168	460.2010 Incentive Air Voids HMA Pavement	34,580.000 DOL	1.00000	34,580.00
0170	460.6224 HMA Pavement 4 MT 58-28 S	6,613.000 TON	_____.	_____.
0172	460.7423 HMA Pavement 3 HT 58-28 H	34,577.000 TON	_____.	_____.





Proposal Schedule of Items

Proposal ID: 20240409007 Project(s): 1060-10-71, 1060-47-70, 1330-47-71, 2788-03-70

Federal ID(s): N/A, N/A, N/A, N/A

SECTION: 0001 Contract Items

Alt Set ID: Alt Mbr ID:

Proposal Line Number	Item ID Description	Approximate Quantity and Units	Unit Price	Bid Amount
0174	460.8624 HMA Pavement 4 SMA 58-28 V	49,422.000 TON	_____.	_____.
0176	460.9000.S Material Transfer Vehicle 001. 1060-47-70	1.000 EACH	_____.	_____.
0178	465.0105 Asphaltic Surface	709.000 TON	_____.	_____.
0180	465.0115 Asphaltic Surface Detours	585.000 TON	_____.	_____.
0182	465.0125 Asphaltic Surface Temporary	2,144.000 TON	_____.	_____.
0184	465.0305 Asphaltic Surface Safety Islands	109.000 TON	_____.	_____.
0186	465.0310 Asphaltic Curb	160.000 LF	_____.	_____.
0188	465.0315 Asphaltic Flumes	11.000 SY	_____.	_____.
0190	465.0510 Asphaltic Rumble Strips, Shoulder Divided Roadway	124,424.000 LF	_____.	_____.
0192	502.0100 Concrete Masonry Bridges	201.000 CY	_____.	_____.
0194	502.3200 Protective Surface Treatment	156.000 SY	_____.	_____.
0196	502.3205 Pigmented Surface Sealer Reseal	473.000 SY	_____.	_____.
0198	502.4204 Adhesive Anchors No. 4 Bar	298.000 EACH	_____.	_____.
0200	504.0100 Concrete Masonry Culverts	6.100 CY	_____.	_____.
0202	505.0600 Bar Steel Reinforcement HS Coated Structures	19,905.000 LB	_____.	_____.



Proposal Schedule of Items

Proposal ID: 20240409007 Project(s): 1060-10-71, 1060-47-70, 1330-47-71, 2788-03-70

Federal ID(s): N/A, N/A, N/A, N/A

SECTION: 0001 Contract Items

Alt Set ID: Alt Mbr ID:

Proposal Line Number	Item ID Description	Approximate Quantity and Units	Unit Price	Bid Amount
0204	505.0904 Bar Couplers No. 4	4.000 EACH	_____.	_____.
0206	505.0905 Bar Couplers No. 5	36.000 EACH	_____.	_____.
0208	505.0906 Bar Couplers No. 6	10.000 EACH	_____.	_____.
0210	506.2610 Bearing Pads Elastomeric Laminated	8.000 EACH	_____.	_____.
0212	506.7050.S Removing Bearings (structure) 001. B-67-245	8.000 EACH	_____.	_____.
0214	509.0301 Preparation Decks Type 1	9.000 SY	_____.	_____.
0216	509.0302 Preparation Decks Type 2	2.500 SY	_____.	_____.
0218	509.0310.S Sawing Pavement Deck Preparation Areas	111.000 LF	_____.	_____.
0220	509.1500 Concrete Surface Repair	118.000 SF	_____.	_____.
0222	509.2100.S Concrete Masonry Deck Repair	1.100 CY	_____.	_____.
0224	509.9050.S Cleaning Parapets	1,201.000 LF	_____.	_____.
0226	511.1200 Temporary Shoring (structure) 001. C-67-25	50.000 SF	_____.	_____.
0228	511.1200 Temporary Shoring (structure) 002. R-67-159	1,000.000 SF	_____.	_____.
0230	511.1200 Temporary Shoring (structure) 003. B-67-245	800.000 SF	_____.	_____.
0232	516.0500 Rubberized Membrane Waterproofing	88.000 SY	_____.	_____.



Proposal Schedule of Items

Proposal ID: 20240409007 Project(s): 1060-10-71, 1060-47-70, 1330-47-71, 2788-03-70

Federal ID(s): N/A, N/A, N/A, N/A

SECTION: 0001 Contract Items

Alt Set ID: Alt Mbr ID:

Proposal Line Number	Item ID Description	Approximate Quantity and Units	Unit Price	Bid Amount
0234	520.8000 Concrete Collars for Pipe	11.000 EACH	_____.	_____.
0236	520.9700.S Culvert Pipe Liners (size) 001. 18-Inch	236.000 LF	_____.	_____.
0238	520.9750.S Cleaning Culvert Pipes for Liner Verification	3.000 EACH	_____.	_____.
0240	521.1012 Apron Endwalls for Culvert Pipe Steel 12-Inch	4.000 EACH	_____.	_____.
0242	521.1018 Apron Endwalls for Culvert Pipe Steel 18-Inch	1.000 EACH	_____.	_____.
0244	521.3118 Culvert Pipe Corrugated Steel 18-Inch	40.000 LF	_____.	_____.
0246	522.0412 Culvert Pipe Reinforced Concrete Class IV 12-Inch	96.000 LF	_____.	_____.
0248	522.0418 Culvert Pipe Reinforced Concrete Class IV 18-Inch	371.000 LF	_____.	_____.
0250	522.0424 Culvert Pipe Reinforced Concrete Class IV 24-Inch	8.000 LF	_____.	_____.
0252	522.1012 Apron Endwalls for Culvert Pipe Reinforced Concrete 12-Inch	2.000 EACH	_____.	_____.
0254	522.1018 Apron Endwalls for Culvert Pipe Reinforced Concrete 18-Inch	3.000 EACH	_____.	_____.
0256	522.2419 Culvert Pipe Reinforced Concrete Horizontal Elliptical Class HE-IV 19x30-Inch	75.000 LF	_____.	_____.
0258	522.2619 Apron Endwalls for Culvert Pipe Reinforced Concrete Horizontal Elliptical 19x30-Inch	2.000 EACH	_____.	_____.



Proposal Schedule of Items

Proposal ID: 20240409007 Project(s): 1060-10-71, 1060-47-70, 1330-47-71, 2788-03-70

Federal ID(s): N/A, N/A, N/A, N/A

SECTION: 0001 Contract Items

Alt Set ID: Alt Mbr ID:

Proposal Line Number	Item ID Description	Approximate Quantity and Units	Unit Price	Bid Amount
0260	524.0624 Apron Endwalls for Culvert Pipe Salvaged 24-Inch	1.000 EACH	_____.	_____.
0262	530.0112 Culvert Pipe Corrugated Polyethylene 12-Inch	131.000 LF	_____.	_____.
0264	531.1100 Concrete Masonry Ancillary Structures Type NS	36.000 CY	_____.	_____.
0266	531.1140 Steel Reinforcement HS Ancillary Structures Type NS	4,968.000 LB	_____.	_____.
0268	531.2020 Drilling Shaft 20-Inch	7.000 LF	_____.	_____.
0270	531.2024 Drilling Shaft 24-Inch	304.000 LF	_____.	_____.
0272	531.2036 Drilling Shaft 36-Inch	118.000 LF	_____.	_____.
0274	531.4030 Foundation Camera Pole 30-FT	1.000 EACH	_____.	_____.
0276	531.4050 Foundation Camera Pole 50-FT	3.000 EACH	_____.	_____.
0278	531.6120 Foundation Two-Shaft Type FF-II (structure) 001. S-67-420	1.000 EACH	_____.	_____.
0280	532.6120 Truss Full Span 4-Chord Type II (structure) 001. S-67-420	1.000 EACH	_____.	_____.
0282	601.0115 Concrete Curb Type G	218.000 LF	_____.	_____.
0284	601.0411 Concrete Curb & Gutter 30-Inch Type D	768.000 LF	_____.	_____.
0286	601.0413 Concrete Curb & Gutter 6-Inch Sloped 30-Inch Type G	2,254.000 LF	_____.	_____.



Proposal Schedule of Items

Proposal ID: 20240409007 Project(s): 1060-10-71, 1060-47-70, 1330-47-71, 2788-03-70

Federal ID(s): N/A, N/A, N/A, N/A

SECTION: 0001 Contract Items

Alt Set ID: Alt Mbr ID:

Proposal Line Number	Item ID Description	Approximate Quantity and Units	Unit Price	Bid Amount
0288	601.0588 Concrete Curb & Gutter 4-Inch Sloped 36-Inch Type TBT	168.000 LF	_____.	_____.
0290	601.0590 Concrete Curb & Gutter 4-Inch Sloped 36-Inch Type TBTT	334.000 LF	_____.	_____.
0292	601.0600 Concrete Curb Pedestrian	23.000 LF	_____.	_____.
0294	602.0405 Concrete Sidewalk 4-Inch	1,272.000 SF	_____.	_____.
0296	602.0410 Concrete Sidewalk 5-Inch	3,736.000 SF	_____.	_____.
0298	602.0505 Curb Ramp Detectable Warning Field Yellow	140.000 SF	_____.	_____.
0300	602.0605 Curb Ramp Detectable Warning Field Radial Yellow	95.000 SF	_____.	_____.
0302	602.3010 Concrete Surface Drains	3.000 CY	_____.	_____.
0304	603.0105 Concrete Barrier Single-Faced 32-Inch	40.000 LF	_____.	_____.
0306	603.1132 Concrete Barrier Type S32	10.000 LF	_____.	_____.
0308	603.1142 Concrete Barrier Type S42	10.000 LF	_____.	_____.
0310	603.3211 Concrete Barrier Transition Type F32SF to S32	1.000 EACH	_____.	_____.
0312	603.3475 Concrete Barrier Transition Type F51DF to S42	1.000 EACH	_____.	_____.
0314	603.8000 Concrete Barrier Temporary Precast Delivered	6,390.000 LF	_____.	_____.



Proposal Schedule of Items

Proposal ID: 20240409007 Project(s): 1060-10-71, 1060-47-70, 1330-47-71, 2788-03-70

Federal ID(s): N/A, N/A, N/A, N/A

SECTION: 0001 Contract Items

Alt Set ID: Alt Mbr ID:

Proposal Line Number	Item ID Description	Approximate Quantity and Units	Unit Price	Bid Amount
0316	603.8125 Concrete Barrier Temporary Precast Installed	6,493.000 LF	_____.	_____.
0318	604.0400 Slope Paving Concrete	11.000 SY	_____.	_____.
0320	604.0500 Slope Paving Crushed Aggregate	672.000 SY	_____.	_____.
0322	606.0100 Riprap Light	4.000 CY	_____.	_____.
0324	606.0200 Riprap Medium	57.000 CY	_____.	_____.
0326	606.0300 Riprap Heavy	28.000 CY	_____.	_____.
0328	608.0312 Storm Sewer Pipe Reinforced Concrete Class III 12-Inch	46.000 LF	_____.	_____.
0330	608.0324 Storm Sewer Pipe Reinforced Concrete Class III 24-Inch	32.000 LF	_____.	_____.
0332	611.0430 Reconstructing Inlets	16.000 EACH	_____.	_____.
0334	611.0530 Manhole Covers Type J	6.000 EACH	_____.	_____.
0336	611.0624 Inlet Covers Type H	4.000 EACH	_____.	_____.
0338	611.0654 Inlet Covers Type V	25.000 EACH	_____.	_____.
0340	611.2005 Manholes 5-FT Diameter	1.000 EACH	_____.	_____.
0342	611.3004 Inlets 4-FT Diameter	1.000 EACH	_____.	_____.
0344	611.3225 Inlets 2x2.5-FT	6.000 EACH	_____.	_____.



Proposal Schedule of Items

Proposal ID: 20240409007 Project(s): 1060-10-71, 1060-47-70, 1330-47-71, 2788-03-70

Federal ID(s): N/A, N/A, N/A, N/A

SECTION: 0001 Contract Items

Alt Set ID: Alt Mbr ID:

Proposal Line Number	Item ID Description	Approximate Quantity and Units	Unit Price	Bid Amount
0346	611.3230 Inlets 2x3-FT	2.000 EACH	_____.	_____.
0348	611.8110 Adjusting Manhole Covers	6.000 EACH	_____.	_____.
0350	611.8115 Adjusting Inlet Covers	9.000 EACH	_____.	_____.
0352	611.9710 Salvaged Inlet Covers	3.000 EACH	_____.	_____.
0354	612.0106 Pipe Underdrain 6-Inch	70.000 LF	_____.	_____.
0356	612.0406 Pipe Underdrain Wrapped 6-Inch	235.000 LF	_____.	_____.
0358	612.0700 Drain Tile Exploration	70.000 LF	_____.	_____.
0360	612.0806 Apron Endwalls for Underdrain Reinforced Concrete 6-Inch	2.000 EACH	_____.	_____.
0362	613.1100.S Cable Barrier Type 1	2,183.000 LF	_____.	_____.
0364	613.1200.S Cable Barrier End Terminal Type 1	3.000 EACH	_____.	_____.
0366	614.0010 Barrier System Grading Shaping Finishing	15.000 EACH	_____.	_____.
0368	614.0150 Anchor Assemblies for Steel Plate Beam Guard	2.000 EACH	_____.	_____.
0370	614.0230 Steel Thrie Beam	13.000 LF	_____.	_____.
0372	614.0396 Guardrail Mow Strip Asphalt	190.000 SY	_____.	_____.
0374	614.0397 Guardrail Mow Strip Emulsified Asphalt	5,499.000 SY	_____.	_____.



Proposal Schedule of Items

Proposal ID: 20240409007 Project(s): 1060-10-71, 1060-47-70, 1330-47-71, 2788-03-70

Federal ID(s): N/A, N/A, N/A, N/A

SECTION: 0001 Contract Items

Alt Set ID: Alt Mbr ID:

Proposal Line Number	Item ID Description	Approximate Quantity and Units	Unit Price	Bid Amount
0376	614.0400 Adjusting Steel Plate Beam Guard	378.000 LF	_____.	_____.
0378	614.0800 Crash Cushions Permanent	1.000 EACH	_____.	_____.
0380	614.0805 Crash Cushions Permanent Low Maintenance	1.000 EACH	_____.	_____.
0382	614.0905 Crash Cushions Temporary	15.000 EACH	_____.	_____.
0384	614.0920 Salvaged Rail	478.000 LF	_____.	_____.
0386	614.0950 Replacing Guardrail Posts and Blocks	75.000 EACH	_____.	_____.
0388	614.0951 Replacing Guardrail Rail and Hardware	49.000 LF	_____.	_____.
0390	614.0952 Replacing Guardrail Reflectors	2.000 EACH	_____.	_____.
0392	614.2300 MGS Guardrail 3	11,151.000 LF	_____.	_____.
0394	614.2330 MGS Guardrail 3 K	275.000 LF	_____.	_____.
0396	614.2350 MGS Guardrail Short Radius	33.000 LF	_____.	_____.
0398	614.2500 MGS Thrie Beam Transition	674.000 LF	_____.	_____.
0400	614.2610 MGS Guardrail Terminal EAT	26.000 EACH	_____.	_____.
0402	614.2620 MGS Guardrail Terminal Type 2	15.000 EACH	_____.	_____.
0404	616.0100 Fence Woven Wire (height) 001. 4-FT	2,262.000 LF	_____.	_____.
0406	616.0206 Fence Chain Link 6-FT	242.000 LF	_____.	_____.





Proposal Schedule of Items

Proposal ID: 20240409007 Project(s): 1060-10-71, 1060-47-70, 1330-47-71, 2788-03-70

Federal ID(s): N/A, N/A, N/A, N/A

SECTION: 0001 Contract Items

Alt Set ID: Alt Mbr ID:

Proposal Line Number	Item ID Description	Approximate Quantity and Units	Unit Price	Bid Amount
0408	616.0700.S Fence Safety	2,470.000 LF	_____.	_____.
0410	618.0100 Maintenance and Repair of Haul Roads (project) 001. 1060-10-71	1.000 EACH	_____.	_____.
0412	619.1000 Mobilization	1.000 EACH	_____.	_____.
0414	620.0300 Concrete Median Sloped Nose	67.000 SF	_____.	_____.
0416	624.0100 Water	849.000 MGAL	_____.	_____.
0418	625.0100 Topsoil	2,989.000 SY	_____.	_____.
0420	625.0500 Salvaged Topsoil	11,571.000 SY	_____.	_____.
0422	627.0200 Mulching	100.000 SY	_____.	_____.
0424	628.1504 Silt Fence	10,359.000 LF	_____.	_____.
0426	628.1520 Silt Fence Maintenance	10,359.000 LF	_____.	_____.
0428	628.1905 Mobilizations Erosion Control	15.000 EACH	_____.	_____.
0430	628.1910 Mobilizations Emergency Erosion Control	15.000 EACH	_____.	_____.
0432	628.2002 Erosion Mat Class I Type A	492.000 SY	_____.	_____.
0434	628.2004 Erosion Mat Class I Type B	10,875.000 SY	_____.	_____.
0436	628.2006 Erosion Mat Urban Class I Type A	665.000 SY	_____.	_____.
0438	628.7005 Inlet Protection Type A	14.000 EACH	_____.	_____.



Proposal Schedule of Items

Proposal ID: 20240409007 Project(s): 1060-10-71, 1060-47-70, 1330-47-71, 2788-03-70

Federal ID(s): N/A, N/A, N/A, N/A

SECTION: 0001 Contract Items

Alt Set ID: Alt Mbr ID:

Proposal Line Number	Item ID Description	Approximate Quantity and Units	Unit Price	Bid Amount
0440	628.7010 Inlet Protection Type B	119.000 EACH	_____.	_____.
0442	628.7015 Inlet Protection Type C	66.000 EACH	_____.	_____.
0444	628.7504 Temporary Ditch Checks	80.000 LF	_____.	_____.
0446	628.7555 Culvert Pipe Checks	11.000 EACH	_____.	_____.
0448	628.7560 Tracking Pads	2.000 EACH	_____.	_____.
0450	628.7570 Rock Bags	10.000 EACH	_____.	_____.
0452	629.0205 Fertilizer Type A	4.000 CWT	_____.	_____.
0454	629.0210 Fertilizer Type B	102.500 CWT	_____.	_____.
0456	630.0120 Seeding Mixture No. 20	14.000 LB	_____.	_____.
0458	630.0130 Seeding Mixture No. 30	50.000 LB	_____.	_____.
0460	630.0140 Seeding Mixture No. 40	10.000 LB	_____.	_____.
0462	630.0200 Seeding Temporary	69.000 LB	_____.	_____.
0464	630.0500 Seed Water	286.000 MGAL	_____.	_____.
0466	631.0300 Sod Water	74.000 MGAL	_____.	_____.
0468	631.1000 Sod Lawn	2,708.000 SY	_____.	_____.
0470	631.1100 Sod Erosion Control	5.000 SY	_____.	_____.



Proposal Schedule of Items

Proposal ID: 20240409007 Project(s): 1060-10-71, 1060-47-70, 1330-47-71, 2788-03-70

Federal ID(s): N/A, N/A, N/A, N/A

SECTION: 0001 Contract Items

Alt Set ID: Alt Mbr ID:

Proposal Line Number	Item ID Description	Approximate Quantity and Units	Unit Price	Bid Amount
0472	633.5200 Markers Culvert End	65.000 EACH	_____.	_____.
0474	634.0618 Posts Wood 4x6-Inch X 18-FT	288.000 EACH	_____.	_____.
0476	634.0622 Posts Wood 4x6-Inch X 22-FT	7.000 EACH	_____.	_____.
0478	634.0814 Posts Tubular Steel 2x2-Inch X 14-FT	25.000 EACH	_____.	_____.
0480	634.0816 Posts Tubular Steel 2x2-Inch X 16-FT	2.000 EACH	_____.	_____.
0482	634.0885 Posts Tubular Steel 2x2-Inch X 8.5-FT	12.000 EACH	_____.	_____.
0484	635.0200 Sign Supports Structural Steel HS	20,900.000 LB	_____.	_____.
0486	637.1220 Signs Type I Reflective SH	3,074.000 SF	_____.	_____.
0488	637.1230 Signs Type I Reflective F	90.000 SF	_____.	_____.
0490	637.2210 Signs Type II Reflective H	2,718.705 SF	_____.	_____.
0492	637.2215 Signs Type II Reflective H Folding	585.380 SF	_____.	_____.
0494	637.2230 Signs Type II Reflective F	228.000 SF	_____.	_____.
0496	638.2101 Moving Signs Type I	2.000 EACH	_____.	_____.
0498	638.2102 Moving Signs Type II	18.000 EACH	_____.	_____.
0500	638.2601 Removing Signs Type I	25.000 EACH	_____.	_____.
0502	638.2602 Removing Signs Type II	374.000 EACH	_____.	_____.



Proposal Schedule of Items

Proposal ID: 20240409007 Project(s): 1060-10-71, 1060-47-70, 1330-47-71, 2788-03-70

Federal ID(s): N/A, N/A, N/A, N/A

SECTION: 0001 Contract Items

Alt Set ID: Alt Mbr ID:

Proposal Line Number	Item ID Description	Approximate Quantity and Units	Unit Price	Bid Amount
0504	638.3000 Removing Small Sign Supports	272.000 EACH	_____.	_____.
0506	638.3100 Removing Structural Steel Sign Supports	36.000 EACH	_____.	_____.
0508	643.0300 Traffic Control Drums	141,812.000 DAY	_____.	_____.
0510	643.0420 Traffic Control Barricades Type III	9,817.000 DAY	_____.	_____.
0512	643.0500 Traffic Control Flexible Tubular Marker Posts	35.000 EACH	_____.	_____.
0514	643.0600 Traffic Control Flexible Tubular Marker Bases	35.000 EACH	_____.	_____.
0516	643.0705 Traffic Control Warning Lights Type A	18,199.000 DAY	_____.	_____.
0518	643.0715 Traffic Control Warning Lights Type C	15,870.000 DAY	_____.	_____.
0520	643.0800 Traffic Control Arrow Boards	1,707.000 DAY	_____.	_____.
0522	643.0900 Traffic Control Signs	39,448.000 DAY	_____.	_____.
0524	643.0910 Traffic Control Covering Signs Type I	4.000 EACH	_____.	_____.
0526	643.0920 Traffic Control Covering Signs Type II	19.000 EACH	_____.	_____.
0528	643.1000 Traffic Control Signs Fixed Message	378.000 SF	_____.	_____.
0530	643.1050 Traffic Control Signs PCMS	675.000 DAY	_____.	_____.
0532	643.1070 Traffic Control Cones 42-Inch	8,544.000 DAY	_____.	_____.
0534	643.1500 Traffic Control Speed Radar Trailer	260.000 DAY	_____.	_____.



Proposal Schedule of Items

Proposal ID: 20240409007 Project(s): 1060-10-71, 1060-47-70, 1330-47-71, 2788-03-70

Federal ID(s): N/A, N/A, N/A, N/A

SECTION: 0001 Contract Items

Alt Set ID: Alt Mbr ID:

Proposal Line Number	Item ID Description	Approximate Quantity and Units	Unit Price	Bid Amount
0536	643.3105 Temporary Marking Line Paint 4-Inch	1,246.000 LF	_____.	_____.
0538	643.3150 Temporary Marking Line Removable Tape 4-Inch	27,942.000 LF	_____.	_____.
0540	643.3165 Temporary Marking Line Paint 6-Inch	304,294.000 LF	_____.	_____.
0542	643.3180 Temporary Marking Line Removable Tape 6-Inch	2,340.000 LF	_____.	_____.
0544	643.3250 Temporary Marking Line Removable Tape 8-Inch	505.000 LF	_____.	_____.
0546	643.3265 Temporary Marking Line Paint 10-Inch	33,703.000 LF	_____.	_____.
0548	643.3760 Temporary Marking Raised Pavement Marker Type I	24.000 EACH	_____.	_____.
0550	643.3770 Temporary Marking Raised Pavement Marker Type II	282.000 EACH	_____.	_____.
0552	643.3850 Temporary Marking Stop Line Removable Tape 18-Inch	150.000 LF	_____.	_____.
0554	643.4100 Traffic Control Interim Lane Closure	291.000 EACH	_____.	_____.
0556	643.5000 Traffic Control	1.000 EACH	_____.	_____.
0558	644.1410 Temporary Pedestrian Surface Asphalt	192.000 SF	_____.	_____.
0560	644.1430 Temporary Pedestrian Surface Plate	208.000 SF	_____.	_____.
0562	644.1601 Temporary Pedestrian Curb Ramp	118.000 DAY	_____.	_____.



Proposal Schedule of Items

Proposal ID: 20240409007 Project(s): 1060-10-71, 1060-47-70, 1330-47-71, 2788-03-70

Federal ID(s): N/A, N/A, N/A, N/A

SECTION: 0001 Contract Items

Alt Set ID: Alt Mbr ID:

Proposal Line Number	Item ID Description	Approximate Quantity and Units	Unit Price	Bid Amount
0564	644.1605 Temporary Pedestrian Detectable Warning Field	70.000 SF	_____.	_____.
0566	644.1810 Temporary Pedestrian Barricade	2,578.000 LF	_____.	_____.
0568	645.0120 Geotextile Type HR	30.000 SY	_____.	_____.
0570	645.0130 Geotextile Type R	19.000 SY	_____.	_____.
0572	646.1020 Marking Line Epoxy 4-Inch	26,497.000 LF	_____.	_____.
0574	646.2020 Marking Line Epoxy 6-Inch	20,283.000 LF	_____.	_____.
0576	646.2025 Marking Line Grooved Black Epoxy 6-Inch	28,347.000 LF	_____.	_____.
0578	646.2040 Marking Line Grooved Wet Ref Epoxy 6-Inch	153,923.000 LF	_____.	_____.
0580	646.2050 Marking Line Grooved Permanent Tape 6-Inch	28,347.000 LF	_____.	_____.
0582	646.3020 Marking Line Epoxy 8-Inch	3,613.000 LF	_____.	_____.
0584	646.4020 Marking Line Epoxy 10-Inch	3,203.000 LF	_____.	_____.
0586	646.4025 Marking Line Grooved Black Epoxy 10-Inch	194.000 LF	_____.	_____.
0588	646.4050 Marking Line Grooved Permanent Tape 10-Inch	16,851.000 LF	_____.	_____.
0590	646.5020 Marking Arrow Epoxy	106.000 EACH	_____.	_____.
0592	646.5120 Marking Word Epoxy	36.000 EACH	_____.	_____.



Proposal Schedule of Items

Proposal ID: 20240409007 Project(s): 1060-10-71, 1060-47-70, 1330-47-71, 2788-03-70

Federal ID(s): N/A, N/A, N/A, N/A

SECTION: 0001 Contract Items

Alt Set ID: Alt Mbr ID:

Proposal Line Number	Item ID Description	Approximate Quantity and Units	Unit Price	Bid Amount
0594	646.5205 Marking Symbol Paint	12.000 EACH	_____.	_____.
0596	646.5220 Marking Symbol Epoxy	13.000 EACH	_____.	_____.
0598	646.5520 Marking Outfall Epoxy	5.000 EACH	_____.	_____.
0600	646.6120 Marking Stop Line Epoxy 18-Inch	984.000 LF	_____.	_____.
0602	646.6220 Marking Yield Line Epoxy 18-Inch	82.000 EACH	_____.	_____.
0604	646.7120 Marking Diagonal Epoxy 12-Inch	2,016.000 LF	_____.	_____.
0606	646.7220 Marking Chevron Epoxy 24-Inch	1,726.000 LF	_____.	_____.
0608	646.7420 Marking Crosswalk Epoxy Transverse Line 6-Inch	409.000 LF	_____.	_____.
0610	646.8020 Marking Corrugated Median Epoxy	72.000 SF	_____.	_____.
0612	646.8120 Marking Curb Epoxy	1,010.000 LF	_____.	_____.
0614	646.8220 Marking Island Nose Epoxy	9.000 EACH	_____.	_____.
0616	646.9000 Marking Removal Line 4-Inch	599.000 LF	_____.	_____.
0618	646.9010 Marking Removal Line Water Blasting 4-Inch	1,976.000 LF	_____.	_____.
0620	646.9055 Marking Removal Line Grooved Contrast Permanent Tape 4-Inch	4,600.000 LF	_____.	_____.
0622	646.9100 Marking Removal Line 8-Inch	280.000 LF	_____.	_____.



Proposal Schedule of Items

Proposal ID: 20240409007 Project(s): 1060-10-71, 1060-47-70, 1330-47-71, 2788-03-70

Federal ID(s): N/A, N/A, N/A, N/A

SECTION: 0001 Contract Items

Alt Set ID: Alt Mbr ID:

Proposal Line Number	Item ID Description	Approximate Quantity and Units	Unit Price	Bid Amount
0624	646.9110 Marking Removal Line Water Blasting 8-Inch	832.000 LF	_____.	_____.
0626	646.9200 Marking Removal Line Wide	55.000 LF	_____.	_____.
0628	646.9210 Marking Removal Line Water Blasting Wide	70.000 LF	_____.	_____.
0630	646.9300 Marking Removal Special Marking	12.000 EACH	_____.	_____.
0632	646.9310 Marking Removal Special Marking Water Blasting	11.000 EACH	_____.	_____.
0634	652.0125 Conduit Rigid Metallic 2-Inch	85.000 LF	_____.	_____.
0636	652.0225 Conduit Rigid Nonmetallic Schedule 40 2-Inch	5,402.000 LF	_____.	_____.
0638	652.0235 Conduit Rigid Nonmetallic Schedule 40 3-Inch	2,048.000 LF	_____.	_____.
0640	652.0240 Conduit Rigid Nonmetallic Schedule 40 4-Inch	24.000 LF	_____.	_____.
0642	652.0605 Conduit Special 2-Inch	800.000 LF	_____.	_____.
0644	652.0615 Conduit Special 3-Inch	3,951.000 LF	_____.	_____.
0646	652.0700.S Install Conduit into Existing Item	12.000 EACH	_____.	_____.
0648	652.0800 Conduit Loop Detector	4,295.000 LF	_____.	_____.
0650	653.0135 Pull Boxes Steel 24x36-Inch	22.000 EACH	_____.	_____.
0652	653.0140 Pull Boxes Steel 24x42-Inch	64.000 EACH	_____.	_____.





Proposal Schedule of Items

Proposal ID: 20240409007 Project(s): 1060-10-71, 1060-47-70, 1330-47-71, 2788-03-70

Federal ID(s): N/A, N/A, N/A, N/A

SECTION: 0001 Contract Items

Alt Set ID: Alt Mbr ID:

Proposal Line Number	Item ID Description	Approximate Quantity and Units	Unit Price	Bid Amount
0654	653.0905 Removing Pull Boxes	96.000 EACH	_____.	_____.
0656	654.0101 Concrete Bases Type 1	13.000 EACH	_____.	_____.
0658	654.0102 Concrete Bases Type 2	5.000 EACH	_____.	_____.
0660	654.0105 Concrete Bases Type 5	2.000 EACH	_____.	_____.
0662	654.0110 Concrete Bases Type 10	3.000 EACH	_____.	_____.
0664	654.0113 Concrete Bases Type 13	5.000 EACH	_____.	_____.
0666	654.0120 Concrete Bases Type 10-Special	10.000 EACH	_____.	_____.
0668	654.0217 Concrete Control Cabinet Bases Type 9 Special	3.000 EACH	_____.	_____.
0670	654.1239 Concrete Control Cabinet Bases ITS	1.000 EACH	_____.	_____.
0672	655.0210 Cable Traffic Signal 3-14 AWG	4,259.000 LF	_____.	_____.
0674	655.0230 Cable Traffic Signal 5-14 AWG	2,713.000 LF	_____.	_____.
0676	655.0240 Cable Traffic Signal 7-14 AWG	4,374.000 LF	_____.	_____.
0678	655.0260 Cable Traffic Signal 12-14 AWG	3,535.000 LF	_____.	_____.
0680	655.0270 Cable Traffic Signal 15-14 AWG	158.000 LF	_____.	_____.
0682	655.0320 Cable Type UF 2-10 AWG Grounded	4,018.000 LF	_____.	_____.
0684	655.0510 Electrical Wire Traffic Signals 12 AWG	432.000 LF	_____.	_____.



Proposal Schedule of Items

Proposal ID: 20240409007 Project(s): 1060-10-71, 1060-47-70, 1330-47-71, 2788-03-70

Federal ID(s): N/A, N/A, N/A, N/A

SECTION: 0001 Contract Items

Alt Set ID: Alt Mbr ID:

Proposal Line Number	Item ID Description	Approximate Quantity and Units	Unit Price	Bid Amount
0686	655.0515 Electrical Wire Traffic Signals 10 AWG	10,975.000 LF	_____.	_____.
0688	655.0610 Electrical Wire Lighting 12 AWG	4,464.000 LF	_____.	_____.
0690	655.0615 Electrical Wire Lighting 10 AWG	280.000 LF	_____.	_____.
0692	655.0620 Electrical Wire Lighting 8 AWG	9,930.000 LF	_____.	_____.
0694	655.0625 Electrical Wire Lighting 6 AWG	10,420.000 LF	_____.	_____.
0696	655.0635 Electrical Wire Lighting 2 AWG	160.000 LF	_____.	_____.
0698	655.0640 Electrical Wire Lighting 1 AWG	18.000 LF	_____.	_____.
0700	655.0700 Loop Detector Lead In Cable	20,435.000 LF	_____.	_____.
0702	655.0800 Loop Detector Wire	12,982.000 LF	_____.	_____.
0704	655.0900 Traffic Signal EVP Detector Cable	4,259.000 LF	_____.	_____.
0706	656.0201 Electrical Service Meter Breaker Pedestal (location) 041. STH 318 & Silvernail Rd.	1.000 EACH	_____.	_____.
0708	656.0201 Electrical Service Meter Breaker Pedestal (location) 051. IH 94 EB Ramps & STH 318	1.000 EACH	_____.	_____.
0710	656.0201 Electrical Service Meter Breaker Pedestal (location) 061. IH 94 WB Ramps & STH 318	1.000 EACH	_____.	_____.
0712	656.0201 Electrical Service Meter Breaker Pedestal (location) 071. IH 94 EB Ramps & CTH T	1.000 EACH	_____.	_____.



Proposal Schedule of Items

Proposal ID: 20240409007 Project(s): 1060-10-71, 1060-47-70, 1330-47-71, 2788-03-70

Federal ID(s): N/A, N/A, N/A, N/A

SECTION: 0001 Contract Items

Alt Set ID: Alt Mbr ID:

Proposal Line Number	Item ID Description	Approximate Quantity and Units	Unit Price	Bid Amount
0714	656.0201 Electrical Service Meter Breaker Pedestal (location) 081. IH 94 WB Ramps & CTH T	1.000 EACH	_____.	_____.
0716	656.0201 Electrical Service Meter Breaker Pedestal (location) 300. MBDMS670040	1.000 EACH	_____.	_____.
0718	656.0201 Electrical Service Meter Breaker Pedestal (location) 301. MBCCTV670244	1.000 EACH	_____.	_____.
0720	656.0501 Electrical Service Breaker Disconnect Box (location) 300. DMS670040	1.000 EACH	_____.	_____.
0722	656.0501 Electrical Service Breaker Disconnect Box (location) 301. CCTV670244	1.000 EACH	_____.	_____.
0724	657.0100 Pedestal Bases	15.000 EACH	_____.	_____.
0726	657.0255 Transformer Bases Breakaway 11 1/2-Inch Bolt Circle	8.000 EACH	_____.	_____.
0728	657.0305 Poles Type 2	3.000 EACH	_____.	_____.
0730	657.0310 Poles Type 3	2.000 EACH	_____.	_____.
0732	657.0420 Traffic Signal Standards Aluminum 13-FT	8.000 EACH	_____.	_____.
0734	657.0425 Traffic Signal Standards Aluminum 15-FT	4.000 EACH	_____.	_____.
0736	657.0430 Traffic Signal Standards Aluminum 10-FT	3.000 EACH	_____.	_____.
0738	657.0609 Luminaire Arms Single Member 4-Inch Clamp 6-FT	2.000 EACH	_____.	_____.
0740	658.0173 Traffic Signal Face 3S 12-Inch	64.000 EACH	_____.	_____.



Proposal Schedule of Items

Proposal ID: 20240409007 Project(s): 1060-10-71, 1060-47-70, 1330-47-71, 2788-03-70

Federal ID(s): N/A, N/A, N/A, N/A

SECTION: 0001 Contract Items

Alt Set ID: Alt Mbr ID:

Proposal Line Number	Item ID Description	Approximate Quantity and Units	Unit Price	Bid Amount
0742	658.0174 Traffic Signal Face 4S 12-Inch	14.000 EACH	_____.	_____.
0744	658.0416 Pedestrian Signal Face 16-Inch	6.000 EACH	_____.	_____.
0746	658.0500 Pedestrian Push Buttons	6.000 EACH	_____.	_____.
0748	658.5070 Signal Mounting Hardware (location) 021. IH 94 EB Ramps & CTH SS	1.000 EACH	_____.	_____.
0750	658.5070 Signal Mounting Hardware (location) 041. STH 318 & Silvernail Rd.	1.000 EACH	_____.	_____.
0752	658.5070 Signal Mounting Hardware (location) 051. IH 94 EB Ramps & STH 318	1.000 EACH	_____.	_____.
0754	658.5070 Signal Mounting Hardware (location) 061. IH 94 WB Ramps & STH 318	1.000 EACH	_____.	_____.
0756	658.5070 Signal Mounting Hardware (location) 071. IH 94 EB Ramps & CTH T	1.000 EACH	_____.	_____.
0758	658.5070 Signal Mounting Hardware (location) 081. IH 94 WB Ramps and CTH T	1.000 EACH	_____.	_____.
0760	659.1125 Luminaires Utility LED C	29.000 EACH	_____.	_____.
0762	659.5000.S Lamp, Ballast, LED, Switch Disposal by Contractor	127.000 EACH	_____.	_____.
0764	661.0201 Temporary Traffic Signals for Intersections (location) 041. STH 318 & Silvernail Rd.	1.000 EACH	_____.	_____.
0766	661.0201 Temporary Traffic Signals for Intersections (location) 051. IH 94 EB Ramps & STH 318	1.000 EACH	_____.	_____.



Proposal Schedule of Items

Proposal ID: 20240409007 Project(s): 1060-10-71, 1060-47-70, 1330-47-71, 2788-03-70

Federal ID(s): N/A, N/A, N/A, N/A

SECTION: 0001 Contract Items

Alt Set ID: Alt Mbr ID:

Proposal Line Number	Item ID Description	Approximate Quantity and Units	Unit Price	Bid Amount
0768	661.0201 Temporary Traffic Signals for Intersections (location) 061. IH 94 WB Ramps & STH 318	1.000 EACH	_____.	_____.
0770	661.0201 Temporary Traffic Signals for Intersections (location) 071. IH 94 EB Ramps & CTH T	1.000 EACH	_____.	_____.
0772	661.0201 Temporary Traffic Signals for Intersections (location) 081. IH 94 WB Ramps & CTH T	1.000 EACH	_____.	_____.
0774	662.1040.S Ramp Closure Gates 40-FT	2.000 EACH	_____.	_____.
0776	662.6020.S Ramp Closure Barricade Rack 2-Unit	2.000 EACH	_____.	_____.
0778	662.6030.S Ramp Closure Barricade Rack 3-Unit	1.000 EACH	_____.	_____.
0780	670.0101 Field System Integrator 071. Traffic Signal Interconnect	1.000 EACH	_____.	_____.
0782	670.0101 Field System Integrator 300. FTMS	1.000 EACH	_____.	_____.
0784	670.0201 ITS Documentation 071. Traffic Signal Interconnect	1.000 EACH	_____.	_____.
0786	670.0201 ITS Documentation 300. FTMS	1.000 EACH	_____.	_____.
0788	673.1200.S Install ITS Field Cabinet	1.000 EACH	_____.	_____.
0790	673.1225.S Install Pole Mounted Cabinet	2.000 EACH	_____.	_____.
0792	674.0300 Remove Cable	130.000 LF	_____.	_____.
0794	674.0400 Reinstall Cable	60.000 LF	_____.	_____.



Proposal Schedule of Items

Proposal ID: 20240409007 Project(s): 1060-10-71, 1060-47-70, 1330-47-71, 2788-03-70

Federal ID(s): N/A, N/A, N/A, N/A

SECTION: 0001 Contract Items

Alt Set ID: Alt Mbr ID:

Proposal Line Number	Item ID Description	Approximate Quantity and Units	Unit Price	Bid Amount
0796	675.0100 Install Controller Ramp Meter Processor Assembly	1.000 EACH	_____.	_____.
0798	675.0300 Install Mounted Controller Microwave Detector Assembly	4.000 EACH	_____.	_____.
0800	677.0130 Install Camera Pole 30-FT	1.000 EACH	_____.	_____.
0802	677.0150 Install Camera Pole 50-FT	3.000 EACH	_____.	_____.
0804	677.0200 Install Camera Assembly	4.000 EACH	_____.	_____.
0806	677.9051.S Removing 50-FT Camera Pole	1.000 EACH	_____.	_____.
0808	677.9200.S Removing CCTV Camera	1.000 EACH	_____.	_____.
0810	678.0006 Install Fiber Optic Cable Outdoor Plant 6-CT	2,630.000 LF	_____.	_____.
0812	678.0100.S Install Overhead Freeway DMS Full Matrix	1.000 EACH	_____.	_____.
0814	678.0200 Fiber Optic Splice Enclosure	3.000 EACH	_____.	_____.
0816	678.0300 Fiber Optic Splice	12.000 EACH	_____.	_____.
0818	678.0400 Fiber Optic Termination	82.000 EACH	_____.	_____.
0820	678.0501 Communication System Testing 071. Traffic Signal Interconnect	1.000 EACH	_____.	_____.
0822	678.0501 Communication System Testing 300. FTMS	1.000 EACH	_____.	_____.
0824	678.0600 Install Ethernet Switches	11.000 EACH	_____.	_____.



Proposal Schedule of Items

Proposal ID: 20240409007 Project(s): 1060-10-71, 1060-47-70, 1330-47-71, 2788-03-70

Federal ID(s): N/A, N/A, N/A, N/A

SECTION: 0001 Contract Items

Alt Set ID: Alt Mbr ID:

Proposal Line Number	Item ID Description	Approximate Quantity and Units	Unit Price	Bid Amount
0826	690.0150 Sawing Asphalt	9,472.000 LF	_____.	_____.
0828	690.0250 Sawing Concrete	49,548.000 LF	_____.	_____.
0830	715.0720 Incentive Compressive Strength Concrete Pavement	500.000 DOL	1.00000	500.00
0832	740.0440 Incentive IRI Ride	58,000.000 DOL	1.00000	58,000.00
0834	999.1950.S Bicycle Rack Asphalt or Concrete-Mounted	2.000 EACH	_____.	_____.
0836	SPV.0035 Special 001. Backfill Slurry	180.000 CY	_____.	_____.
0838	SPV.0045 Special 001. Basic Traffic Queue Warning System	30.000 DAY	_____.	_____.
0840	SPV.0045 Special 002. Digital Speed Reduction System (DSRS)	291.000 DAY	_____.	_____.
0842	SPV.0060 Special 001. Tension Anchor Rods	64.000 EACH	_____.	_____.
0844	SPV.0060 Special 002. Remove Grout Pad	2.000 EACH	_____.	_____.
0846	SPV.0060 Special 003. Remove Debris and Regrade	1.000 EACH	_____.	_____.
0848	SPV.0060 Special 004. Adjust Sign	2.000 EACH	_____.	_____.
0850	SPV.0060 Special 005. U-Bolt	16.000 EACH	_____.	_____.
0852	SPV.0060 Special 006. Remove Catwalk	5.000 EACH	_____.	_____.
0854	SPV.0060 Special 007. Lower Structure	3.000 EACH	_____.	_____.



Proposal Schedule of Items

Proposal ID: 20240409007 Project(s): 1060-10-71, 1060-47-70, 1330-47-71, 2788-03-70

Federal ID(s): N/A, N/A, N/A, N/A

SECTION: 0001 Contract Items

Alt Set ID: Alt Mbr ID:

Proposal Line Number	Item ID Description	Approximate Quantity and Units	Unit Price	Bid Amount
0856	SPV.0060 Special 008. Re-install Truss/Arm	2.000 EACH	_____.	_____.
0858	SPV.0060 Special 009. Vertical Sign Support	1.000 EACH	_____.	_____.
0860	SPV.0060 Special 010. Strapping C-67-1570	2.000 EACH	_____.	_____.
0862	SPV.0060 Special 011. Catwalk Repair	1.000 EACH	_____.	_____.
0864	SPV.0060 Special 012. Replace Conduit Connector	6.000 EACH	_____.	_____.
0866	SPV.0060 Special 050. Survey Project	1.000 EACH	_____.	_____.
0868	SPV.0060 Special 051. Baseline CPM Progress Schedule	1.000 EACH	_____.	_____.
0870	SPV.0060 Special 052. Monthly CPM Progress Schedule Updates	14.000 EACH	_____.	_____.
0872	SPV.0060 Special 053. Traffic Control Close-Open Freeway Entrance Ramp	45.000 EACH	_____.	_____.
0874	SPV.0060 Special 054. Traffic Control Full Freeway Closure	10.000 EACH	_____.	_____.
0876	SPV.0060 Special 055. Mobilization Emergency Pavement Repair	8.000 EACH	_____.	_____.
0878	SPV.0060 Special 056. Field Facilities Office Space	1.000 EACH	_____.	_____.
0880	SPV.0060 Special 057. Utility Line Opening (ULO)	15.000 EACH	_____.	_____.
0882	SPV.0060 Special 058. Section Corner Monuments Special	2.000 EACH	_____.	_____.





Proposal Schedule of Items

Proposal ID: 20240409007 Project(s): 1060-10-71, 1060-47-70, 1330-47-71, 2788-03-70

Federal ID(s): N/A, N/A, N/A, N/A

SECTION: 0001 Contract Items

Alt Set ID: Alt Mbr ID:

Proposal Line Number	Item ID Description	Approximate Quantity and Units	Unit Price	Bid Amount
0884	SPV.0060 Special 059. Remove and Reset Cable Barrier Post	1.000 EACH	_____.	_____.
0886	SPV.0060 Special 060. Curb Ramp Grading and Shaping	9.000 EACH	_____.	_____.
0888	SPV.0060 Special 101. Concrete Barrier Transition to Curb	2.000 EACH	_____.	_____.
0890	SPV.0060 Special 102. Fastening Sewer Access Covers	6.000 EACH	_____.	_____.
0892	SPV.0060 Special 103. Reset Existing Bearings	18.000 EACH	_____.	_____.
0894	SPV.0060 Special 201. Install Poles Type 9	1.000 EACH	_____.	_____.
0896	SPV.0060 Special 202. Install Poles Type 9 Special	1.000 EACH	_____.	_____.
0898	SPV.0060 Special 203. Install Poles Type 10	2.000 EACH	_____.	_____.
0900	SPV.0060 Special 204. Install Poles Type 10 Special	9.000 EACH	_____.	_____.
0902	SPV.0060 Special 205. Install Poles Type 12	1.000 EACH	_____.	_____.
0904	SPV.0060 Special 206. Install Poles Type 13	4.000 EACH	_____.	_____.
0906	SPV.0060 Special 207. Install Monotube Arms 15-FT	1.000 EACH	_____.	_____.
0908	SPV.0060 Special 208. Install Monotube Arms 25-FT	2.000 EACH	_____.	_____.
0910	SPV.0060 Special 209. Install Monotube Arms 35-FT-Special	3.000 EACH	_____.	_____.



Proposal Schedule of Items

Proposal ID: 20240409007 Project(s): 1060-10-71, 1060-47-70, 1330-47-71, 2788-03-70

Federal ID(s): N/A, N/A, N/A, N/A

SECTION: 0001 Contract Items

Alt Set ID: Alt Mbr ID:

Proposal Line Number	Item ID Description	Approximate Quantity and Units	Unit Price	Bid Amount
0912	SPV.0060 Special 210. Install Monotube Arms 45-FT-Special	7.000 EACH	_____.	_____.
0914	SPV.0060 Special 211. Install Monotube Arms 50-FT	2.000 EACH	_____.	_____.
0916	SPV.0060 Special 212. Install Monotube Arms 55-FT	3.000 EACH	_____.	_____.
0918	SPV.0060 Special 213. Install Luminaire Arms Steel 15-FT	23.000 EACH	_____.	_____.
0920	SPV.0060 Special 214. Traffic Signal Reflective Backplate 3S	3.000 EACH	_____.	_____.
0922	SPV.0060 Special 215. Traffic Signal Reflective Backplate 4S	2.000 EACH	_____.	_____.
0924	SPV.0060 Special 216. Trnspt & Install State Furn Traffic Signal Cabinet STH 318 & Silvernail Road	1.000 EACH	_____.	_____.
0926	SPV.0060 Special 217. Trnspt & Install State Furn Traffic Signal Cabinet IH 94 EB Ramps & STH 318	1.000 EACH	_____.	_____.
0928	SPV.0060 Special 218. Trnspt & Install State Furn Traffic Signal Cabinet IH 94 WB Ramps & STH 318	1.000 EACH	_____.	_____.
0930	SPV.0060 Special 219. Trnspt & Install State Furn Traffic Signal Cabinet IH 94 EB Ramps & CTH T	1.000 EACH	_____.	_____.
0932	SPV.0060 Special 220. Trnspt & Install State Furn Traffic Signal Cabinet IH 94 WB Ramps & CTH T	1.000 EACH	_____.	_____.



Proposal Schedule of Items

Proposal ID: 20240409007 Project(s): 1060-10-71, 1060-47-70, 1330-47-71, 2788-03-70

Federal ID(s): N/A, N/A, N/A, N/A

SECTION: 0001 Contract Items

Alt Set ID: Alt Mbr ID:

Proposal Line Number	Item ID Description	Approximate Quantity and Units	Unit Price	Bid Amount
0934	SPV.0060 Special 221. Trnspt & Install State Furn EVP Heads & Con Light STH 318 & Silvernail Road	1.000 EACH	_____.	_____.
0936	SPV.0060 Special 222. Trnspt & Install State Furn EVP Heads & Con Light IH 94 EB Ramps & STH 318	1.000 EACH	_____.	_____.
0938	SPV.0060 Special 223. Trnspt & Install State Furn EVP Heads & Con Light IH 94 WB Ramps & STH 318	1.000 EACH	_____.	_____.
0940	SPV.0060 Special 224. Trnspt & Install State Furn EVP Heads & Con Light IH 94 EB Ramps & CTH T	1.000 EACH	_____.	_____.
0942	SPV.0060 Special 225. Trnspt & Install State Furn EVP Heads & Con Light IH 94 WB Ramps & CTH T	1.000 EACH	_____.	_____.
0944	SPV.0060 Special 226. Trnspt Traffic Signals & Inter Lighting Materials STH 318 & Silvernail Road	1.000 EACH	_____.	_____.
0946	SPV.0060 Special 227. Trnspt Traffic Signals & Inter Lighting Materials IH 94 EB Ramps & STH 318	1.000 EACH	_____.	_____.
0948	SPV.0060 Special 228. Trnspt Traffic Signals & Inter Lighting Materials IH 94 WB Ramps & STH 318	1.000 EACH	_____.	_____.
0950	SPV.0060 Special 229. Trnspt Traffic Signals & Inter Lighting Materials IH 94 EB Ramps & CTH T	1.000 EACH	_____.	_____.
0952	SPV.0060 Special 230. Trnspt Traffic Signals & Inter Lighting Materials IH 94 WB Ramps & CTH T	1.000 EACH	_____.	_____.



Proposal Schedule of Items

Proposal ID: 20240409007 Project(s): 1060-10-71, 1060-47-70, 1330-47-71, 2788-03-70

Federal ID(s): N/A, N/A, N/A, N/A

SECTION: 0001 Contract Items

Alt Set ID: Alt Mbr ID:

Proposal Line Number	Item ID Description	Approximate Quantity and Units	Unit Price	Bid Amount
0954	SPV.0060 Special 231. Trnspt & Install S-F Radar Detection System IH 94 EB Ramps & CTH T	1.000 EACH	_____.	_____.
0956	SPV.0060 Special 232. Trnspt & Install S-F Radar Detection System IH 94 WB Ramps & CTH T	1.000 EACH	_____.	_____.
0958	SPV.0060 Special 233. Airport Obstruction Lights L810	15.000 EACH	_____.	_____.
0960	SPV.0060 Special 234. Concrete Control Cabinet Bases Type 9 Special Super P	2.000 EACH	_____.	_____.
0962	SPV.0060 Special 235. Temporary EVP System STH 318 & Silvernail Road	1.000 EACH	_____.	_____.
0964	SPV.0060 Special 236. Temporary EVP System IH 94 EB Ramps & STH 318	1.000 EACH	_____.	_____.
0966	SPV.0060 Special 237. Temporary EVP System IH 94 WB Ramps & STH 318	1.000 EACH	_____.	_____.
0968	SPV.0060 Special 238. Temporary EVP System IH 94 EB Ramps & CTH T	1.000 EACH	_____.	_____.
0970	SPV.0060 Special 239. Temporary EVP System IH 94 WB Ramps & CTH T	1.000 EACH	_____.	_____.
0972	SPV.0060 Special 250. Remove and Reinstall Fiber Optic Pigtail STH 318 & Silvernail Road	1.000 EACH	_____.	_____.
0974	SPV.0060 Special 251. Remove and Reinstall Fiber Optic Pigtail IH 94 EB Ramps & STH 318	1.000 EACH	_____.	_____.
0976	SPV.0060 Special 252. Remove and Reinstall Fiber Optic Pigtail IH 94 WB Ramps & STH 318	1.000 EACH	_____.	_____.



Proposal Schedule of Items

Proposal ID: 20240409007 Project(s): 1060-10-71, 1060-47-70, 1330-47-71, 2788-03-70

Federal ID(s): N/A, N/A, N/A, N/A

SECTION: 0001 Contract Items

Alt Set ID: Alt Mbr ID:

Proposal Line Number	Item ID Description	Approximate Quantity and Units	Unit Price	Bid Amount
0978	SPV.0060 Special 253. Remove and Reinstall Fiber Optic Pigtail IH 94 EB Ramps & CTH T	1.000 EACH	_____.	_____.
0980	SPV.0060 Special 254. Remove and Reinstall Fiber Optic Pigtail IH 94 WB Ramps & CTH T	1.000 EACH	_____.	_____.
0982	SPV.0060 Special 255. Relocate Existing Pull Box	1.000 EACH	_____.	_____.
0984	SPV.0060 Special 300. Remove Pole	2.000 EACH	_____.	_____.
0986	SPV.0060 Special 301. Ground Rod	5.000 EACH	_____.	_____.
0988	SPV.0060 Special 302. Refocus Vehicle Detector Assembly	24.000 EACH	_____.	_____.
0990	SPV.0060 Special 303. Removing Controller Cabinet Base	1.000 EACH	_____.	_____.
0992	SPV.0060 Special 304. Removing Controller Cabinet	1.000 EACH	_____.	_____.
0994	SPV.0060 Special 401. Modify Lighting Control Cabinets 120/240	1.000 EACH	_____.	_____.
0996	SPV.0060 Special 402. Maintenance of Lighting Systems (1060-47-70)	1.000 EACH	_____.	_____.
0998	SPV.0060 Special 403. Lighting System Integrator (1060-47-70)	1.000 EACH	_____.	_____.
1000	SPV.0060 Special 404. Lighting System Survey (1060-47-70)	1.000 EACH	_____.	_____.
1002	SPV.0090 Special 001. Concrete Barrier 51-Inch Special	688.000 LF	_____.	_____.



Proposal Schedule of Items

Proposal ID: 20240409007 Project(s): 1060-10-71, 1060-47-70, 1330-47-71, 2788-03-70

Federal ID(s): N/A, N/A, N/A, N/A

SECTION: 0001 Contract Items

Alt Set ID: Alt Mbr ID:

Proposal Line Number	Item ID Description	Approximate Quantity and Units	Unit Price	Bid Amount
1004	SPV.0090 Special 002. Marking Epoxy 4-Inch Black Non Grooved	1,046.000 LF	_____.	_____.
1006	SPV.0090 Special 003. Marking Epoxy 6-Inch Black Non Grooved	1,896.000 LF	_____.	_____.
1008	SPV.0090 Special 004. Marking Epoxy 8-Inch Black Non Grooved	221.000 LF	_____.	_____.
1010	SPV.0090 Special 005. Marking Epoxy 10-Inch Black Non Grooved	290.000 LF	_____.	_____.
1012	SPV.0090 Special 006. Concrete Barrier Wall Epoxy Crack Sealing	850.000 LF	_____.	_____.
1014	SPV.0090 Special 300. Outdoor Rated Network Cable	360.000 LF	_____.	_____.
1016	SPV.0090 Special 401. Cable Aerial Aluminum 6 AWG Triplex	1,030.000 LF	_____.	_____.
1018	SPV.0165 Special 001. Repair Galvanized Coating	26.000 SF	_____.	_____.
1020	SPV.0165 Special 002. Wall Modular Block Mechanically Stabilized Earth R-67-159	1,240.000 SF	_____.	_____.
1022	SPV.0165 Special 003. Concrete Barrier Wall Surface Repair	640.000 SF	_____.	_____.
1024	SPV.0180 Special 001. Methacrylate Flood Seal	8,944.000 SY	_____.	_____.
1026	SPV.0180 Special 002. Resin Binder High Friction Surface Treatment	7,274.000 SY	_____.	_____.
1028	SPV.0180 Special 003. Micromilling for Base Patching	45,212.000 SY	_____.	_____.



Proposal Schedule of Items

Proposal ID: 20240409007 Project(s): 1060-10-71, 1060-47-70, 1330-47-71, 2788-03-70

Federal ID(s): N/A, N/A, N/A, N/A

SECTION: 0001 Contract Items

Alt Set ID: Alt Mbr ID:

Proposal Line Number	Item ID Description	Approximate Quantity and Units	Unit Price	Bid Amount
1030	SPV.0195 Special 001. HMA Longitudinal Joint Repair	2,100.000 TON	_____.	_____.
1032	SPV.0195 Special 002. Asphaltic Repair	183.000 TON	_____.	_____.
<b>Section: 0001</b>			<b>Total:</b>	_____.
			<b>Total Bid:</b>	_____.

**PLEASE ATTACH ADDENDA HERE**





# Wisconsin Department of Transportation

March 25, 2024

**Division of Transportation Systems Development**  
Bureau of Project Development  
4822 Madison Yards Way, 4<sup>th</sup> Floor South  
Madison, WI 53705

## NOTICE TO ALL CONTRACTORS:

Telephone: (608) 266-1631  
Facsimile (FAX): (608) 266-8459

**Proposal #07: 1060-10-71**  
**IH 94 East West Freeway**  
**CTH T and CTH JJ (B-67-240,245)**  
**IH 94**  
**Waukesha County**

**1060-47-70**  
**IH 94 East West Freeway**  
**STH 83 to STH 16**  
**IH 94**  
**Waukesha County**

**1330-47-71**  
**C Delafield, State Road 83**  
**Nagawaukee Park and Ride Lot**  
**Off Sys**  
**Waukesha County**

**2788-03-70**  
**C Waukesha Meadowbrook Road**  
**Rolling Ridge Dr to IH 94 EB Ramps**  
**STH 318**  
**Waukesha County**

## Letting of April 9, 2024

This is Addendum No. 01, which provides for the following:

### Plan Sheets:

<b>Added Plan Sheets – 1060-47-70</b>	
Plan Sheet	Plan Sheet Title (brief description of why sheet was added)
773A	S-67-19
773B	S-67-39
773C	S-67-40
773D	S-67-41
773E	S-67-42
773F	S-67-239
773G	S-67-240
773H	S-67-245
773I	S-67-308
773J	S-67-406
773K-773T	S-67-420
773U	S-67-602

The responsibility for notifying potential subcontractors and suppliers of these changes remains with the prime contractor.

Sincerely,

*Mike Coleman*

Proposal Development Specialist  
Proposal Management Section

END OF ADDENDUM

STATE PROJECT NUMBER  
1060-47-70

**GENERAL NOTES:**

- DRAWINGS SHALL NOT BE SCALED
- ALTERNATE DESIGNS ARE NOT ALLOWED
- UNLESS DETAILED OTHERWISE IN THE PLANS, ALL H.S. BOLTED CONNECTIONS SHALL BE MADE WITH 3/4" DIA. A325 GALVANIZED BOLTS. FIELD CONNECTIONS SHALL BE INSTALLED WITH DTI WASHERS.
- ALL H.S. BOLTS, NUTS, AND WASHERS SHALL BE GALVANIZED PER SECTION 532 OF THE WISDOT STANDARD SPECIFICATIONS.
- CONTRACTOR SHALL VERIFY DIMENSIONS PRIOR TO FABRICATIONS OF STRUCTURE COMPONENTS.
- CONTRACTOR SHALL VERIFY EXACT LOCATIONS OF ALL REPAIRS.
- EXISTING SIGN DESIGN AREA FROM HS5 IS 340 S.F.
- THE ANCHOR ROD NUTS AND WASHERS SHALL BE GALVANIZED IN ACCORDANCE WITH SECTION 532 OF THE WISDOT STANDARD SPECIFICATIONS.
- REMOVE GROUT PAD AND AS STATED BELOW. REMOVE ALL OF THE EXISTING GROUT PADS AND ANY SURROUNDING DEGRADED CONCRETE DOWN TO UNDISTURBED FIRM SUBGRADE. REMOVE ALL EXISTING ANCHOR RODS AND INSTALL RODDENT SCREEN AROUND THE ANCHOR ROD LEVELING NUTS.
- U-BOLTS SHALL BE STAINLESS STEEL AND MANUFACTURED TO THE PROPER SIZE TO FIT THE CHORDS OF THE OVERHEAD SIGN STRUCTURE.

**TRAFFIC DATA:**

IH94 A.A.D.T. = 88,500 (2019)  
IH94 A.A.D.T. = 96,465 (2045)  
R.D.S. = 70 MPH

**Material Properties**

- STRUCTURAL ANGLES  
PLATE AND BARS - ASTM A709 GRADE 36  $f_y = 36,000$  psi  
HIGH STRENGTH BOLTS - A325  $f_y = 92,000$  psi  
ANCHOR RODS - ASTM F1554 GRADE 55  $f_y = 55,000$  psi
- HEAVY HEX NUTS FOR ANCHOR RODS - ASTM A563A  
WASHERS FOR ANCHOR RODS - ASTM F436
- STAINLESS U-BOLTS AND LOCKWASHERS - ASTM 304  
STAINLESS HEX NUTS - ASTM A276

**Addendum No. 01**  
**ID 1060-47-70**  
**Added Sheet 773A**  
**March 25, 2024**

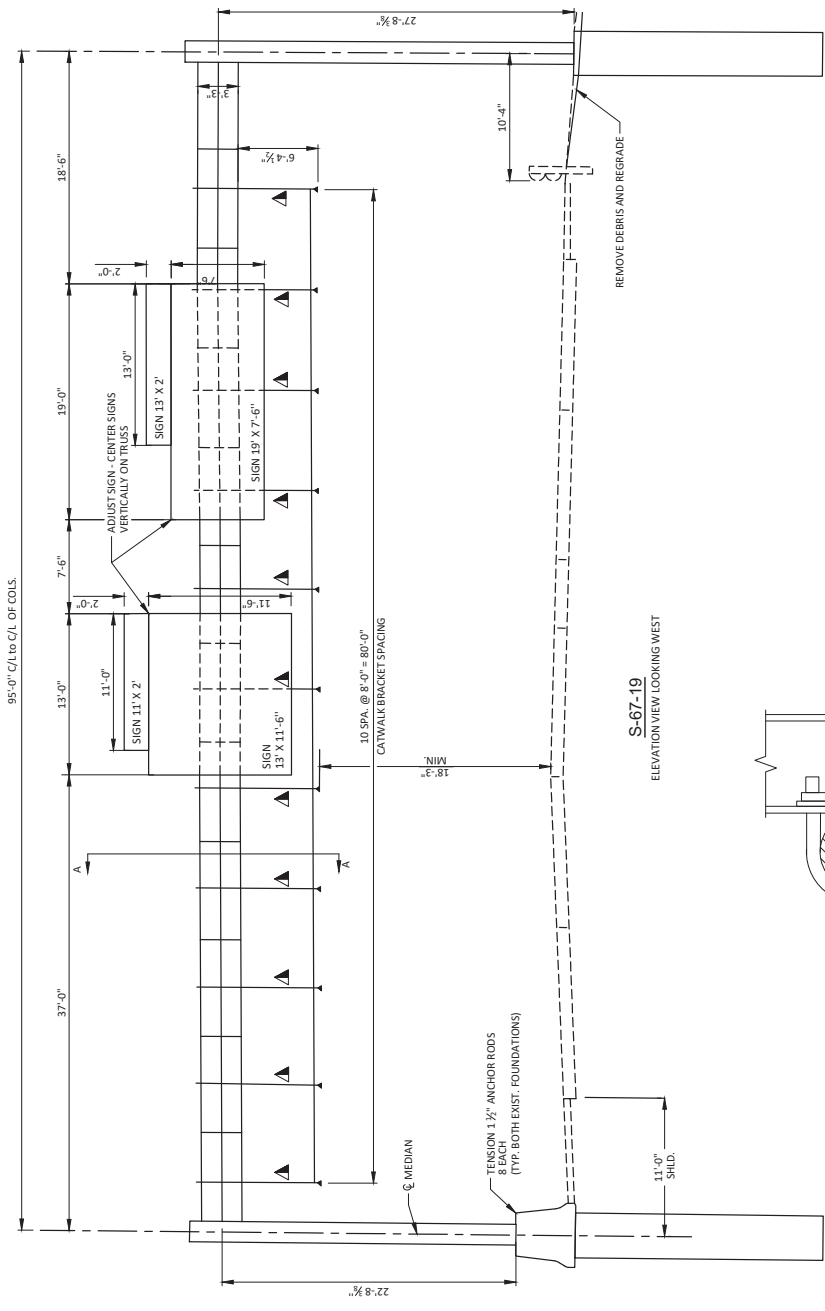

**S-67-19**  
ELEVATION VIEW LOOKING WEST

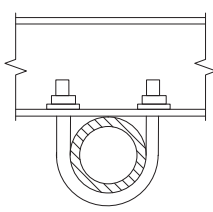

**U-BOLT CONNECTION DETAIL**

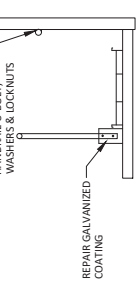

**CUT SECTION A-A**

TOTAL ESTIMATED QUANTITIES		
ITEM NUMBER	BID ITEM	TOTAL
SPV.0860.001	TENSION ANCHOR RODS	EA 16
SPV.0860.002	REMOVE GROUT PAD	EA 2
SPV.0860.003	REMOVE DEBRIS AND REGRADE	EA 1
SPV.0860.004	ADJUST SIGN	EA 2
SPV.0860.005	U-BOLTS	EA 16
SPV.0185.001	REPAIR GALVANIZED COATING	SF 10



DESIGN CONSULTANT  
TOM ROMNESKO, PE  
(808) 565-1370

BRIDGE OFFICE CONTACT  
MARCON BOKH, PE  
(808) 281-0261

ACCEPTED  02/13/24 DATE

DAAR ENGINEERING, INC.  
1000 W. WISCONSIN AVENUE  
MADISON, WI 53706

DEPARTMENT OF TRANSPORTATION  
CHIEF STRUCTURAL DESIGN ENGINEER

**STRUCTURE S-67-19**

W 19' 6" AT GORE TO 5TH IS NB

COUNTY	WALWESHA
DESIGN SPEC.	TOWN/MUNICIPALITY/TOWNSHIP
APPROVED BY	DESIGNATION
DATE	DATE

**GENERAL PLAN**

SHEET 1 OF 1  
**773A**

STATE PROJECT NUMBER  
1060-47-70

**GENERAL NOTES:**

- DRAWINGS SHALL NOT BE SCALED
- ALTERNATE DESIGNS ARE NOT ALLOWED
- ALL HS, BOLTS, NUTS, AND WASHERS SHALL BE GALVANIZED PER SECTION 532 OF THE WISDOT STANDARD SPECIFICATIONS.
- CONTRACTOR SHALL VERIFY DIMENSIONS PRIOR TO FABRICATIONS OF STRUCTURE COMPONENTS.
- EXISTING SIGN DESIGN AREA FROM HS65 IS 220 S.F.
- STEEL ANCHOR ROD NUTS AND WASHERS SHALL BE ASTM A-576
- ANCHOR ROD NUTS AND WASHERS SHALL BE GALVANIZED IN ACCORDANCE WITH SECTION 532 OF THE WISDOT STANDARD SPECIFICATIONS.
- REMOVE ALL TRACES OF GRIT AND DUST FROM THE BLASTING SURFACE OF ALL STRUCTURE COMPONENTS.
- GALVANIZING MATERIAL AS SOON AS POSSIBLE AFTER CLEANING AND BEFORE VISIBLE OXIDATION OF THE SURFACE OCCURS. THE CONTRACTOR SHALL NOT WAIT TO APPLY THE COATING MORE THAN 8 HOURS AFTER CLEANING.

**TRAFFIC DATA:**

IHS4 A.A.D.T. = 88,500 (2019)  
IHS4 A.A.D.T. = 96,465 (2043)  
R.O.S. = 70 MPH

**MATERIAL PROPERTIES**

- STRUCTURAL ANGLES  
PLATE AND BARS - ASTM A709 GRADE 36  
fy = 36,000 psi
- HIGH STRENGTH BOLTS - A325  
fy = 92,000 psi
- ANCHOR RODS - ASTM F1554 GRADE 55  
fy = 55,000 psi
- HEAVY HEX NUTS FOR ANCHOR RODS - ASTM A563A
- WASHERS FOR ANCHOR RODS - ASTM F436

**Addendum No. 01  
ID 1060-47-70  
Added Sheet 773B  
March 25, 2024**

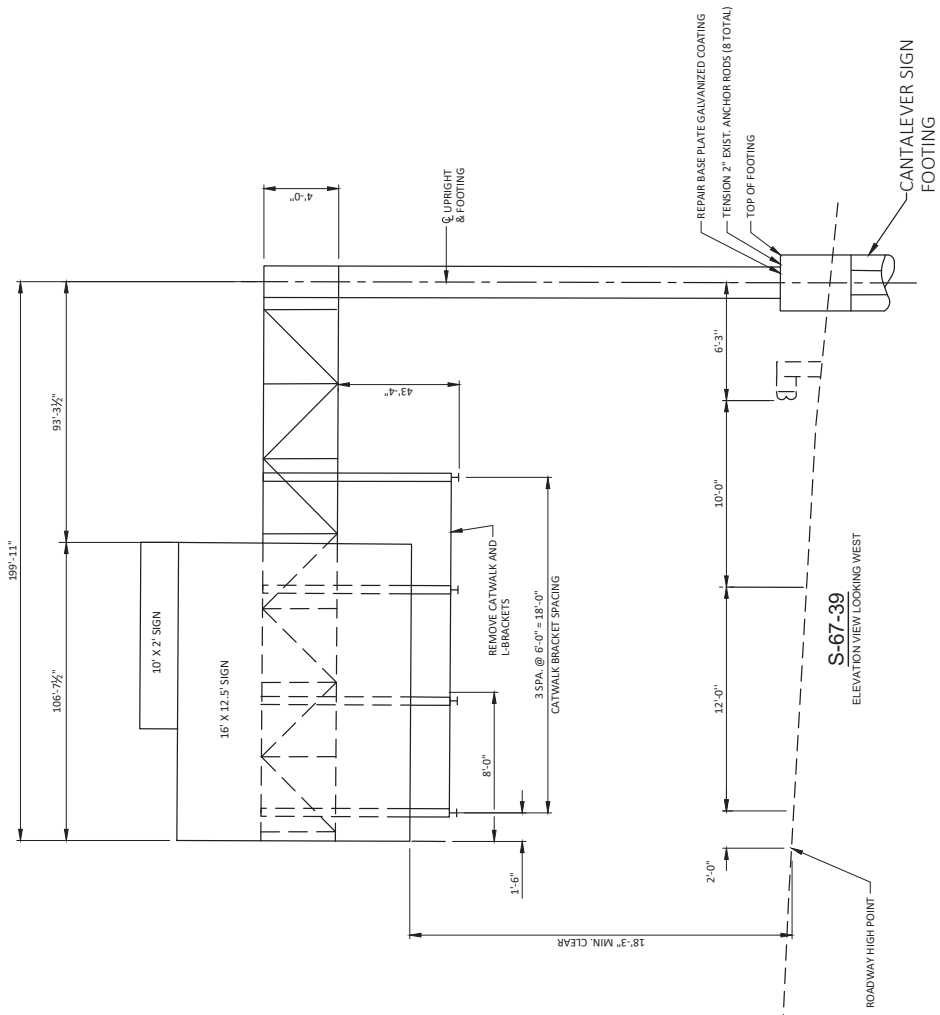

TOTAL ESTIMATED QUANTITIES			
ITEM NUMBER	BID ITEM	UNIT	TOTAL
SPV.0060.001	TENSION ANCHOR ROD	EA	8
SPV.0060.006	REMOVE CATWALK	EA	1
SPV.0166.001	REPAIR GALVANIZED COATING	SF	8



DESIGN CONSULTANT  
TOM ROMENSKO, PE  
(808) 566-1370

BRIDGE OFFICE CONTACT  
MARCUS BOK, PE  
(808) 281-4261

**GENERAL PLAN**  
SHEET 1 OF 1  
**773B**

NO.	DATE	REVISION	BY

DAAR  
DESIGN & ENGINEERING, INC.  
1000 W. WISCONSIN AVENUE  
MADISON, WI 53706  
PH: 608.261.1200

ACCEPTED  
DATE: 02/13/24

STATE OF WISCONSIN  
DEPARTMENT OF TRANSPORTATION  
CHIEF STRUCTURAL DESIGN ENGINEER

STRUCTURE S-67-39

HWY 94 NB, 1/4 MILE E OF CRTG  
COUNTY: WAUKESHA  
TOWNSHIP: WAUKESHA

DESIGN SPEC.  
ASPH/ALD BRIDGE DESSIGN SPECIFICATIONS

DESIGNED BY: [Signature] TR  
CHECKED BY: [Signature] TR  
DRAWN BY: [Signature] TR

STATE PROJECT NUMBER  
1060-47-70

**GENERAL NOTES:**

- DRAWINGS SHALL NOT BE SCALED
- ALTERNATE DESIGNS ARE NOT ALLOWED
- ALL HS, BOLTS, NUTS, AND WASHERS SHALL BE GALVANIZED PER SECTION 532 OF THE WISDOT STANDARD SPECIFICATIONS.
- CONTRACTOR SHALL VERIFY DIMENSIONS PRIOR TO FABRICATIONS OF STRUCTURE COMPONENTS.
- EXISTING SIGN DESIGN AREA FROM HS IS 260 S.F.
- STEEL ANCHOR ROD NUTS AND WASHERS SHALL BE ASTM A-576.
- ANCHOR ROD NUTS AND WASHERS SHALL BE GALVANIZED IN ACCORDANCE WITH SECTION 532 OF THE WISDOT STANDARD SPECIFICATIONS.
- REMOVE ALL TRACES OF GRIT AND DUST FROM THE BLASTING SURFACE BEFORE GALVANIZED COATING. APPLY A COMPATIBLE GALVANIZING MATERIAL AS SOON AS POSSIBLE AFTER CLEANING AND BEFORE VISIBLE DETERIORATION OF THE SURFACE OCCURS. THE CONTRACTOR SHALL BE RESPONSIBLE TO APPLY THE COATING MORE THAN 8 HOURS AFTER CLEANING.

**TRAFFIC DATA:**

IH94 A.A.D.T. = 88,500 (2019)  
IH94 A.A.D.T. = 96,465 (2043)  
R.D.S. = 70 MPH

**MATERIAL PROPERTIES**

- CONCRETE MASONRY  $f_c = 3,500$  psi
- HIGH STRENGTH STEEL REINFORCEMENT, GRADE 60  $f_y = 60,000$  psi
- STRUCTURAL ANGLES PLATE AND BARS - ASTM A709 GRADE 36  $f_y = 36,000$  psi
- HIGH STRENGTH BOLTS - A325  $f_y = 92,000$  psi
- ANCHOR RODS - ASTM F1554 GRADE 55  $f_y = 55,000$  psi
- HEAVY HEX NUTS FOR ANCHOR RODS - ASTM A563A
- WASHERS FOR ANCHOR RODS - ASTM F436

Addendum No. 01  
ID 1060-47-70  
Added Sheet 773C  
March 25, 2024



**DAAR ENGINEERING, INC.**  
1000 W. WISCONSIN ST. SUITE 200  
MADISON, WI 53706  
PH: 608.261.1234

ACCEPTED *[Signature]* SRB  
DATE: 02/13/24

NO.	DATE	REVISION	BY
DEPARTMENT OF TRANSPORTATION CHIEF STRUCTURAL DESIGN ENGINEER			
<b>STRUCTURE S-67-40</b>			
I-94 WB, 1/2 MILE E. OF 57H13B			
COUNTY	WALWESHA	TOWN/CITY/VILLAGE/MUNICIPALITY	
DESIGN SPEC.	WISCONSIN STANDARD SPECIFICATIONS FOR HIGHWAY CONSTRUCTION		
DESIGNED BY	TR	CHECKED BY	TR
DRAWN BY	MC	IN CHARGE	TR
GENERAL PLAN			SHEET 1 OF 1 <b>773C</b>

DESIGN CONSULTANT  
TOM ROMENSKO, PE  
(808) 565-1370

BRIDGE OFFICE CONTACT  
MARCONSON, PE  
(808) 281-0261

PROJECT SCALE: 1" = 8'-0"

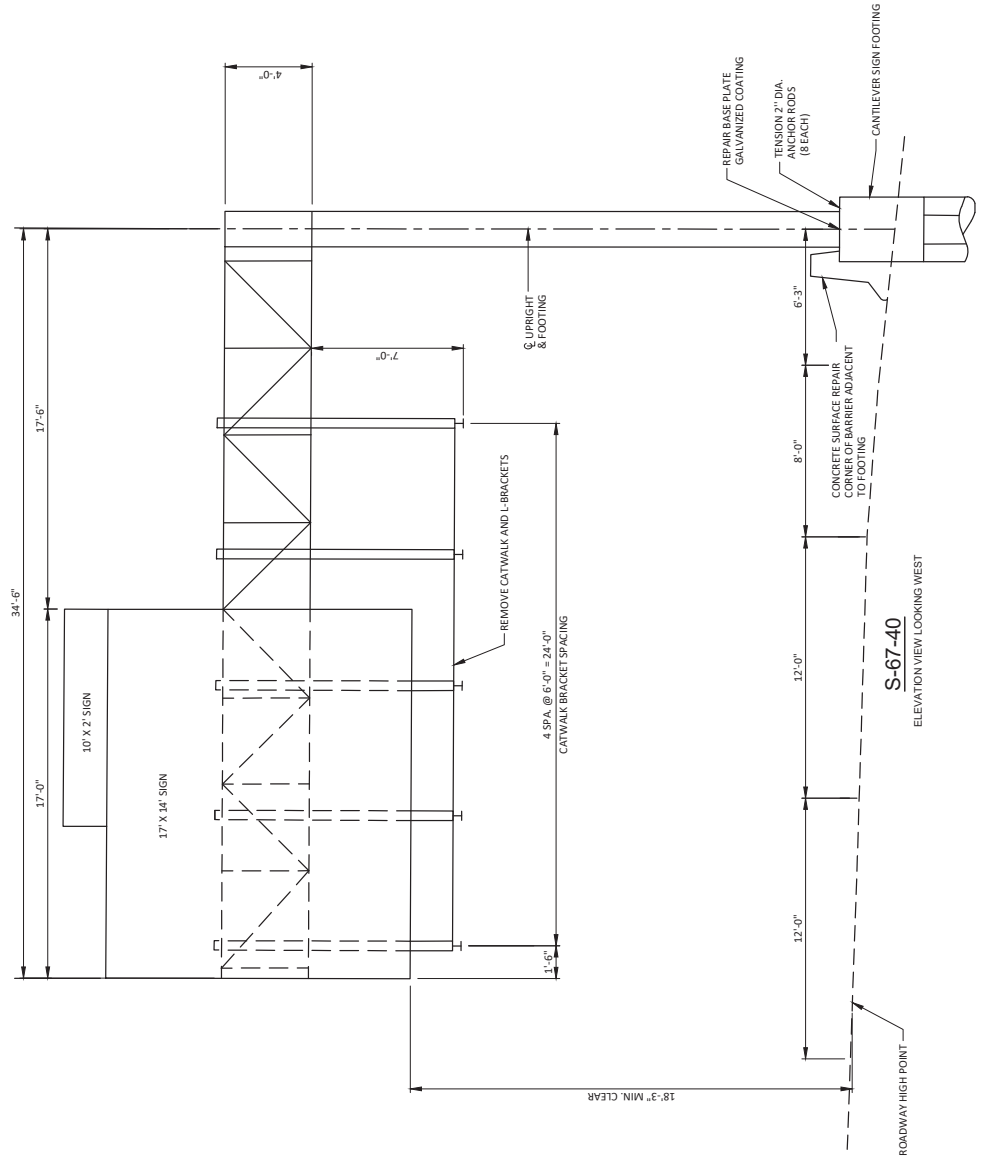

**TOTAL ESTIMATED QUANTITIES**

ITEM NUMBER	BID ITEM	UNIT	TOTAL
500.1500	CONCRETE SURFACE REPAIR	SF	5
SPV.0862.001	TENSION ANCHOR ROD	EA	8
SPV.0860.006	REMOVE CATWALK	EA	1
SPV.0165.001	REPAIR GALVANIZED COATING	SF	8

STATE PROJECT NUMBER  
1060-47-70

**GENERAL NOTES:**

DRAWINGS SHALL NOT BE SCALED  
EXISTING SIGN DESIGN AREA FROM HIS IS 190 S.F.

**TRAFFIC DATA:**

1194 AADT = 88,500 (2019)  
1194 AADT = 96,465 (2043)  
K.D.S. = 70 MPH

Addendum No. 01  
ID 1060-47-70  
Added Sheet 773D  
March 25, 2024

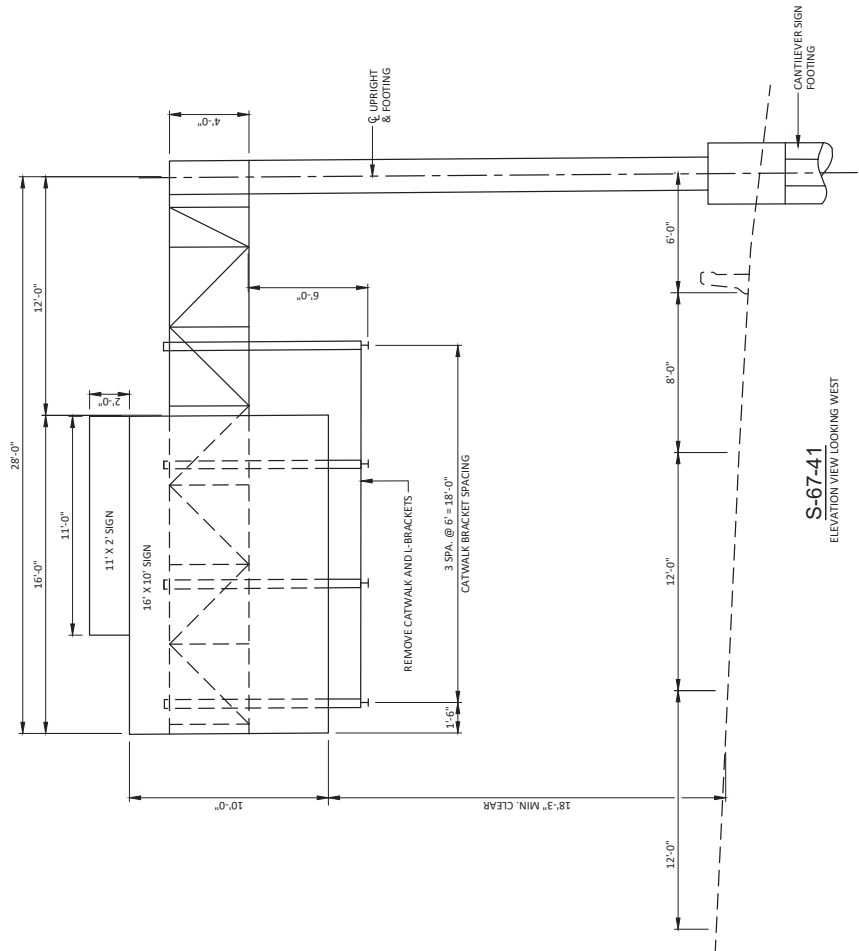

**S-6741**  
ELEVATION VIEW LOOKING WEST

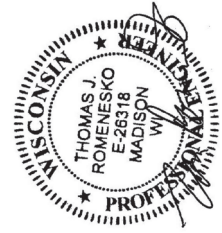

NO.	DATE	REVISION	BY
		DAK ENGINEERING, INC. 1000 W. WISCONSIN ST. MADISON, WI 53706	
		STATE OF WISCONSIN DEPARTMENT OF TRANSPORTATION ACCEPTED	DATE 02/13/24
<b>STRUCTURE S-67-41</b>			
1/4 MI. 1/4 MILE E. OF CR155			
COUNTY		TOWN/TOWNSHIP/COUNTY	
WALWISHEA		WALWISHEA	
DESIGN SPEC. ASSISTED BRIDGE DESIGN SPECIFICATIONS			
DESIGNED BY	TR.	CHKD BY	TR.
MC	TR	MC	TR
MC	TR	MC	TR
DESIGN CONSULTANT			BRIDGE OFFICE CONTACT
TOM ROMNESKO, PE (808) 568-1370			MARONSONK, PE (808) 281-0261
<b>GENERAL PLAN</b>			SHEET 1 OF 1
			<b>773D</b>

TOTAL ESTIMATED QUANTITIES			
ITEM NUMBER	BID ITEM	UNIT	TOTAL
SPV.0060.006	REMOVE CATWALK	EA	1

STATE PROJECT NUMBER  
1060-47-70

**GENERAL NOTES:**

DRAWINGS SHALL NOT BE SCALED  
ALTERNATE DESIGNS ARE NOT ALLOWED  
ALL HS, BOLTS, NUTS, AND WASHERS SHALL BE GALVANIZED PER SECTION 532 OF THE WISDOT STANDARD SPECIFICATIONS.  
CONTRACTOR SHALL VERIFY DIMENSIONS PRIOR TO FABRICATIONS OF STRUCTURE COMPONENTS.  
EXISTING SIGN DESIGN AREA FROM HSIS IS 199 S.F.  
STEEL ANCHOR ROD NUTS AND WASHERS SHALL BE ASTM A-576.

**TRAFFIC DATA:**

HH94 A.A.D.T. = 88,500 (20319)  
HH94 A.A.D.T. = 96,465 (20431)  
R.D.S. = 70 mph

**MATERIAL PROPERTIES**

STRUCTURAL ANGLES  
PLATE AND BARS - ASTM A709 GRADE 36 fy = 36,000 psi  
HIGH STRENGTH BOLTS - A325 fy = 92,000 psi  
ANCHOR RODS - ASTM F1554 GRADE 55 fy = 55,000 psi  
HEAVY HEX NUTS FOR ANCHOR RODS - ASTM A563A  
WASHERS FOR ANCHOR RODS - ASTM F436

Addendum No. 01  
ID 1060-47-70  
Added Sheet 773E  
March 25, 2024

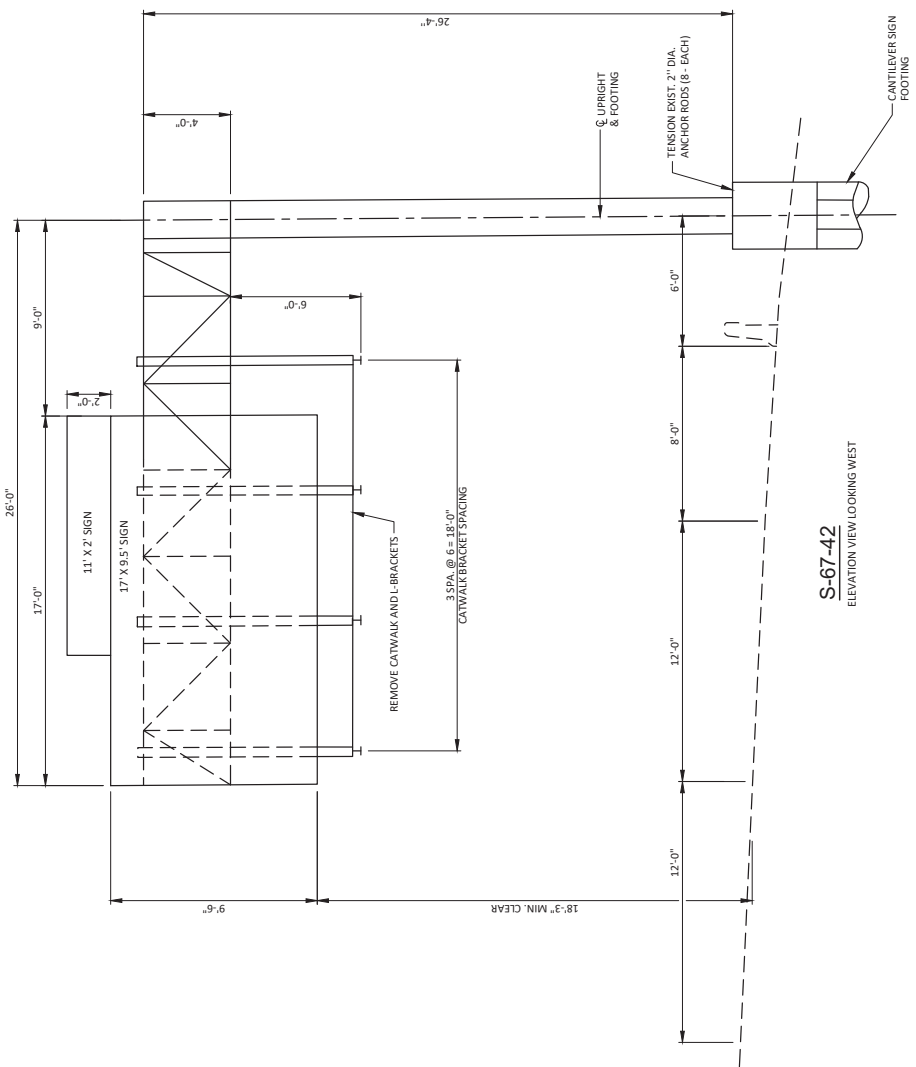

**S-67-42**  
ELEVATION VIEW LOOKING WEST

TOTAL ESTIMATED QUANTITIES			
ITEM NUMBER	UNIT	TOTAL	
SPV.0060.001	EA	8	
SPV.0060.006	EA	1	

NO.	DATE	REVISION	BY
		DATE OF ADOPTION	
		DATE	



STATE OF WISCONSIN  
DEPARTMENT OF TRANSPORTATION  
ACCEPTED  
SR  
02/13/24  
DATE

STRUCTURE S-67-42  
HWY 94 WB, 1/2 MILE E. OF CR153  
COUNTY: WAUKESHA  
DESIGN SPEC.  
AS SHOWN UNLESS OTHERWISE SPECIFIED  
DESIGNED BY: [Signature]  
CHECKED BY: [Signature]  
DATE: [Signature]

**GENERAL PLAN**  
SHEET 1 OF 1  
773E



DESIGN CONSULTANT  
TOM ROMENSKO, PE  
(808) 566-1370  
BRIDGE OFFICE CONTACT  
MARGON BOKN, PE  
(808) 281-0261

STATE PROJECT NUMBER  
1060-47-70

**GENERAL NOTES:**

- DRAWINGS SHALL NOT BE SCALED
- ALTERNATE DESIGNS ARE NOT ALLOWED
- ALL HS. BOLTS, NUTS AND WASHERS SHALL BE GALVANIZED PER SECTION 532 OF THE WISDOT STANDARD SPECIFICATIONS.
- CONTRACTOR SHALL VERIFY DIMENSIONS PRIOR TO FABRICATIONS OF STRUCTURE COMPONENTS.
- EXISTING SIGN DESIGN AREA FROM HS16 58.5 S.F.
- ANCHOR ROD NUTS AND WASHERS SHALL BE GALVANIZED IN ACCORDANCE WITH SECTION 532 OF THE WISDOT STANDARD SPECIFICATIONS.

**TRAFFIC DATA:**

STH 318 A AD T = 3,600 (2019)  
R.D.S = 40 MPH

**MATERIAL PROPERTIES**

- STRUCTURAL ANGLES  
PLATE AND BARS - ASTM A709 GRADE 36  
fy = 36,000 psi
- HIGH STRENGTH BOLTS - A325  
fy = 92,000 psi
- ANCHOR RODS - ASTM F1554 GRADE 55  
fy = 55,000 psi
- HEAVY HEX NUTS FOR ANCHOR RODS - ASTM A563A
- WASHERS FOR ANCHOR RODS - ASTM F436

Addendum No. 01  
ID 1060-47-70  
Added Sheet 773F  
March 25, 2024

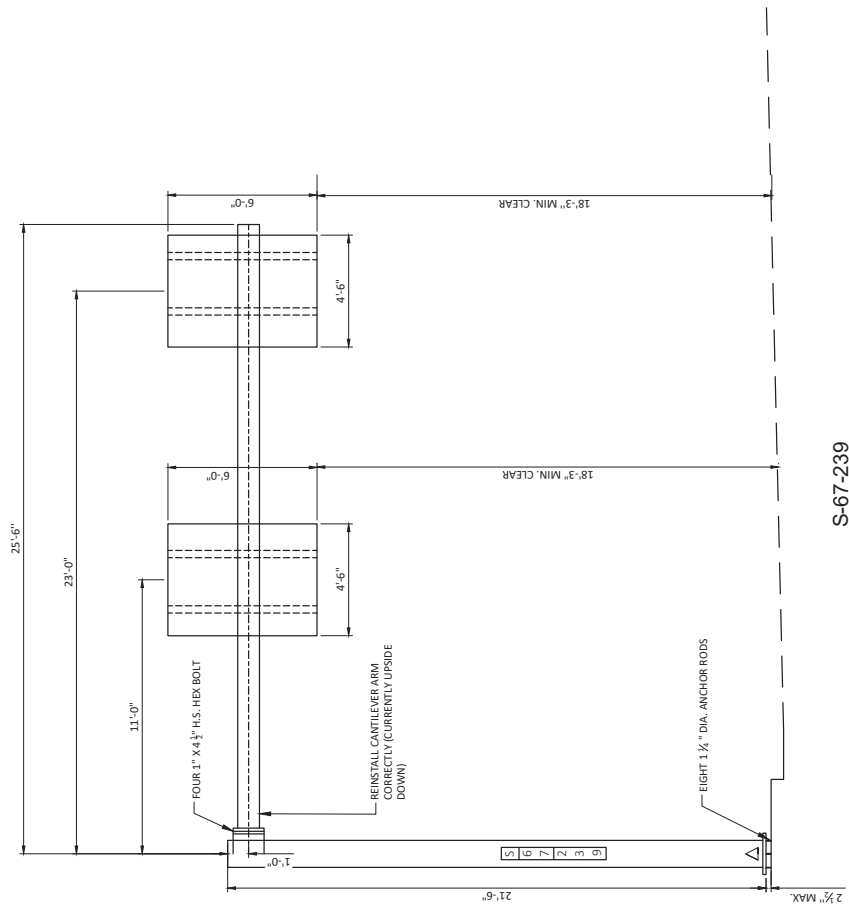

S-67-239  
ELEVATION VIEW (LOOKING NORTH)

- △ REMOVE MAST ARM AND COLUMN, LOWER BASE PLATE TO 2 1/2" MAX. FROM TOP OF CONCRETE TO BOTTOM OF BASE PLATE. REMOVE LOCK WASHERS.

TOTAL ESTIMATED QUANTITIES			
ITEM NUMBER	BID ITEM	UNIT	TOTAL
SPV.0060.001	TENSION ANCHOR ROD	EA	8
SPV.0060.007	LOWER STRUCTURE	EA	1
SPV.0060.008	RE-INSTALL TRUSS/ARM	EA	1

NO.	DATE	REVISION	BY
 DAK ENGINEERING, INC. 1000 W. WISCONSIN AVE., SUITE 200 MADISON, WI 53706 PHONE: 608.261.2281			
STATE OF WISCONSIN DEPARTMENT OF TRANSPORTATION		ACCEPTED  THOMAS J. ROMENSKO SENIOR STRUCTURAL DESIGN ENGINEER	
STRUCTURE S-67-239		DATE 02/13/24	
371366 LT TURN TO RAMP ON RAMP			
COUNTY	WALWISHEA	TOWN	WALWISHEA TOWNSHIP
DESIGN SPEC.	ASHTO LRFD BRIDGE DESIGN SPECIFICATIONS		
DESIGNED BY	MC	TR	TR
CHECKED BY	MC	TR	TR
<b>GENERAL PLAN</b>			SHEET 1 OF 1 <b>773F</b>



DESIGN CONSULTANT  
TOM ROMENSKO, PE  
(608) 566-1370

BRIDGE OFFICE CONTACT  
MARON BONK, PE  
(608) 281-0261

STATE PROJECT NUMBER  
1060-47-70

**GENERAL NOTES:**

DRAWINGS SHALL NOT BE SCALED  
 ALTERNATE DESIGNS ARE NOT ALLOWED  
 ALL HS BOLTS, NUTS, AND WASHERS SHALL BE GALVANIZED PER SECTION 532 OF THE WISDOT STANDARD SPECIFICATIONS.  
 CONTRACTOR SHALL VERIFY DIMENSIONS PRIOR TO FABRICATIONS OF STRUCTURE COMPONENTS.  
 EXISTING SIGN DESIGN AREA FROM HBS IS 28 S.F.  
 ANCHOR ROD NUTS AND WASHERS SHALL BE GALVANIZED IN ACCORDANCE WITH SECTION 532 OF THE WISDOT STANDARD SPECIFICATIONS.

**TRAFFIC DATA:**

STH 318 A.A.D.T. = 9,400 (2019)  
 R.D.S. = 40 MPH  
 IH94 A.A.D.T. = 88,500 (2019)  
 IH94 A.A.D.T. = 96,465 (2043)  
 R.D.S. = 70 MPH

**MATERIAL PROPERTIES**

STRUCTURAL ANGLES  
 PLATE AND BARS - ASTM A709 GRADE 36  
 $f_y = 36,000$  psi  
 HIGH STRENGTH BOLTS - A325  
 $f_y = 92,000$  psi  
 ANCHOR RODS - ASTM F1554 GRADE 55  
 $f_y = 55,000$  psi  
 HEAVY HEX NUTS FOR ANCHOR RODS - ASTM A563A  
 WASHERS FOR ANCHOR RODS - ASTM F436

Addendum No. 01  
 ID 1060-47-70  
 Added Sheet 773G  
 March 25, 2024

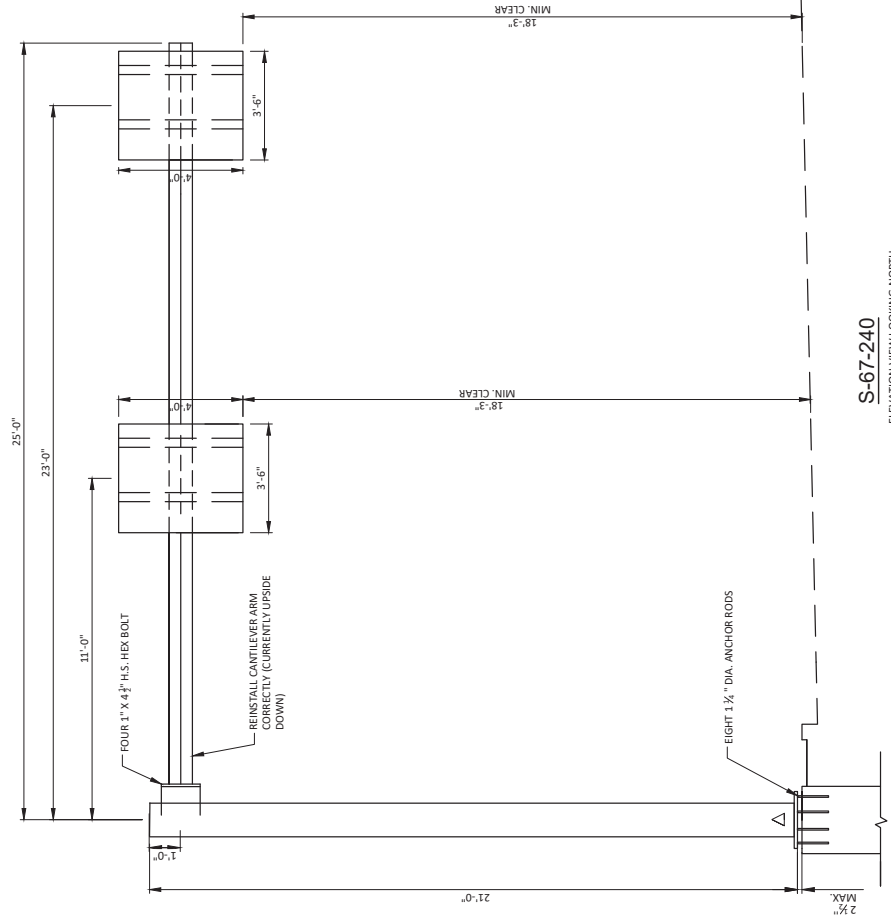

S-67-240  
ELEVATION VIEW LOOKING NORTH

△ REMOVE WAST ARM AND COLUMN LOWER BASE PLATE TO 2 1/2" MAX FROM TOP OF CONCRETE TO BOTTOM OF BASE PLATE. REMOVE LOCK WASHERS.

TOTAL ESTIMATED QUANTITIES			
ITEM NUMBER	BID ITEM	UNIT	TOTAL
SPV.0060.001	TENSION ANCHOR ROD	EA	8
SPV.0060.007	LOWER STRUCTURE	EA	1
SPV.0060.008	RE-INSTALL TRUSS ARM	EA	1



DESIGN CONSULTANT  
 TOM ROMENSKO, PE  
 (808) 566-1370

BRIDGE OFFICE CONTACT  
 MARCON BOK, PE  
 (808) 281-0261

NO.	DATE	REVISION	BY

DAK ENGINEERING, INC.  
 1000 W. WISCONSIN AVENUE  
 MADISON, WI 53706  
 (608) 261-1370

ACCEPTED  
 [Signature]  
 CHIEF STRUCTURAL ENGINEER

DATE: 02/13/24

STRUCTURE S-67-240

3113 S.E. 17<sup>TH</sup> TURN TO R414 W  
 COUNTY: WAUKESHA  
 TOWN: FARMINGTON  
 DESIGN SPEC.:  
 ASHFIELD BRIDGE DESIGN SPECIFICATIONS

DESIGNED BY:	MC	CC	TR	BY	MC	CC	TR
CHECKED BY:	MC	CC	TR	BY	MC	CC	TR

SHEET 1 OF 1  
**773G**



STATE PROJECT NUMBER  
1060-47-70

**GENERAL NOTES:**

DRAWINGS SHALL NOT BE SCALED  
ALTERNATE DESIGNS ARE NOT ALLOWED  
ALL HS, BOLTS, NUTS, AND WASHERS SHALL BE  
STANDARD SECTION S32 OF THE WRODOT  
STANDARD SPECIFICATIONS.  
CONTRACTOR SHALL VERIFY DIMENSIONS PRIOR TO  
FABRICATIONS OF STRUCTURE COMPONENTS.  
EXISTING SIGN DESIGN AREA FROM IBSIS IS 14 S.F.

**TRAFFIC DATA:**

STH 318 A.A.D.T. = 3,600 (2019)  
R.D.S. = 40 MPH  
R.D.S. = 40 MPH  
R.D.S. = 40 MPH  
R.D.S. = 70 MPH

Addendum No. 01  
ID 1060-47-70  
Added Sheet 773H  
March 25, 2024

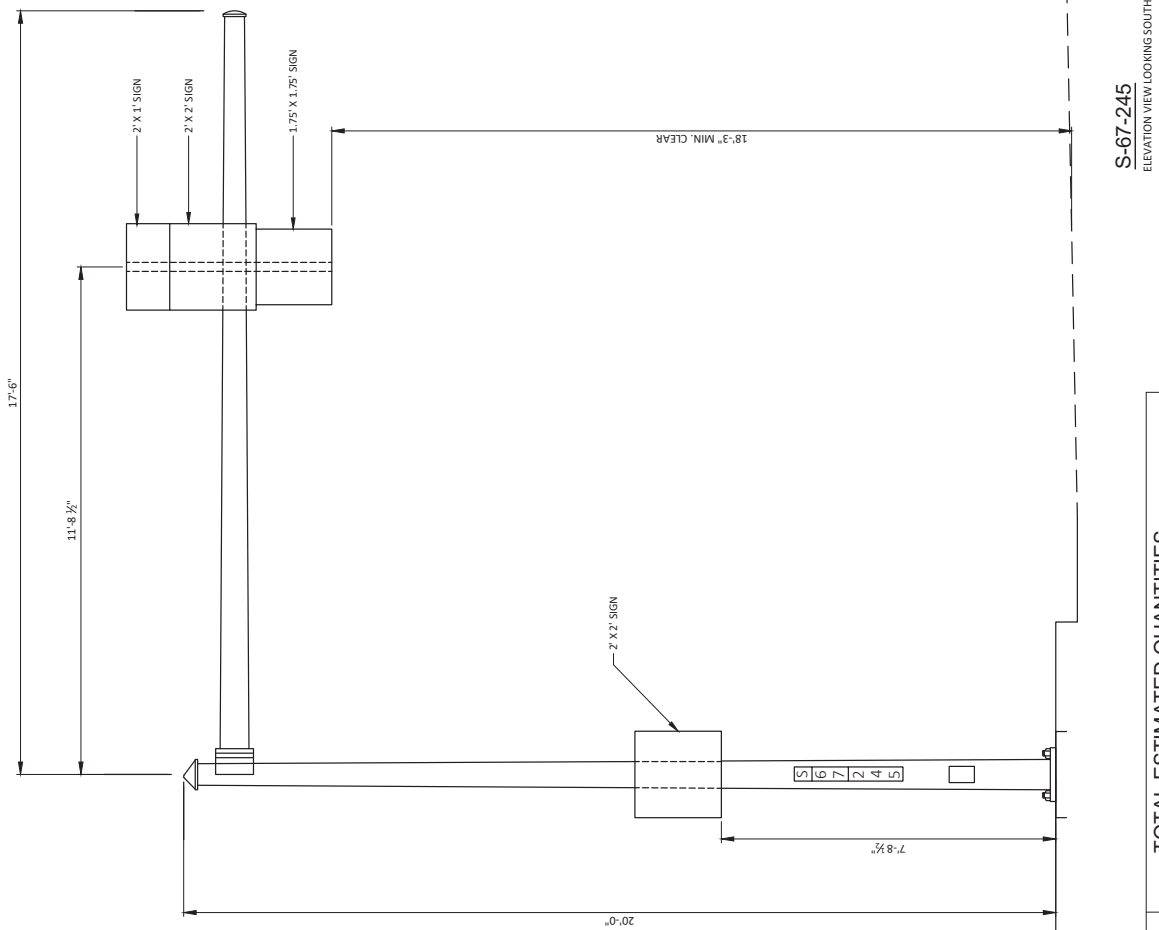

**S-67-245**  
ELEVATION VIEW LOOKING SOUTH

**TOTAL ESTIMATED QUANTITIES**

ITEM NUMBER	BID ITEM	UNIT	TOTAL
SPV.0080.009	VERTICAL SIGN SUPPORT	EA	1



DESIGN CONSULTANT  
TOM ROMNESKO, PE  
(808) 568-1370

BRIDGE OFFICE CONTACT  
MARGON BOKK, PE  
(808) 281-0281

NO.	DATE	REVISION	BY
		DAAR ENGINEERING, INC. 1100 W. WASHINGTON ST. MILWAUKEE, WI 53233 PHONE: 414-224-1100	
		STATE OF WISCONSIN DEPARTMENT OF TRANSPORTATION ACCEPTED	
	02/13/24	DATE	
		STRUCTURE S-67-245	
		CH 153.9, AT TURN LANE TO THE LEFT	
		COUNTY: WAUKESHA	
		TOWN: WASHINGTON	
		DESIGN SPEC: ASHFD BRIDGE DESIGN SPECIFICATIONS	
		DESIGNED BY: [Signature]	
		CHECKED BY: [Signature]	
		DATE: 02/13/24	
		PROJECT NUMBER: 1060-47-70	
		SHEET 1 OF 1	
		773H	

STATE PROJECT NUMBER  
1060-47-70

**GENERAL NOTES:**

DRAWINGS SHALL NOT BE SCALED  
ALTERNATE DESIGNS ARE NOT ALLOWED  
ALL HS. BOLTS, NUTS, AND WASHERS SHALL BE GALVANIZED PER SECTION 532 OF THE WISDOT STANDARD SPECIFICATIONS.  
EXISTING SIGN DESIGN AREA FROM HS 15 IS 90 S.F.

**TRAFFIC DATA:**

HS 94 AADT = 79,900 (2019)  
HS 94 AADT = 96,465 (2043)  
R.D.S. = 70 MPH

Addendum No. 01  
ID 1060-47-70  
Added Sheet 7731  
March 25, 2024

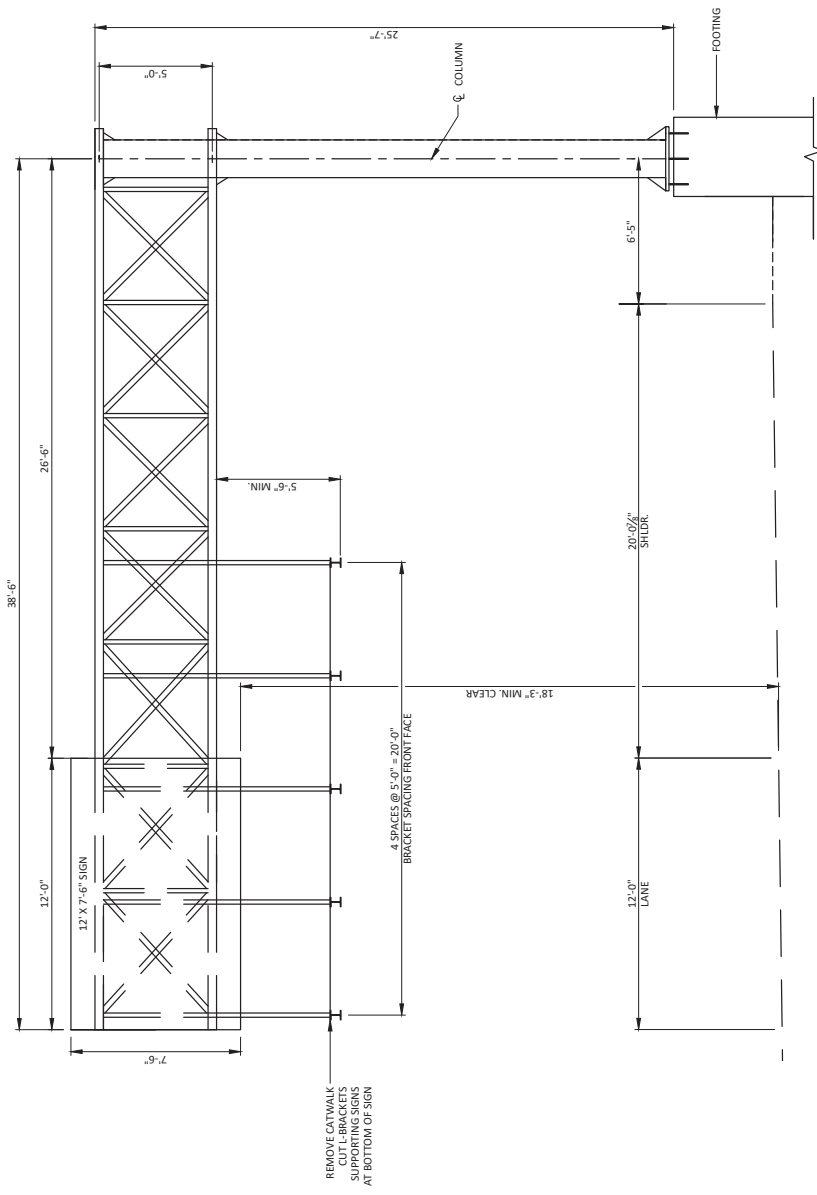

TOTAL ESTIMATED QUANTITIES			
ITEM NUMBER	BID ITEM	UNIT	TOTAL
SPV.0080.006	REMOVE CATWALK	EA	1



DESIGN CONSULTANT  
TOM ROMENSKO, PE  
(808) 566-1370

BRIDGE OFFICE CONTACT  
MARGON BOK, PE  
(808) 281-0261

NO.	DATE	REVISION	BY
		DAAR ENGINEERING, INC. 1200 W. WASHINGTON MILWAUKEE, WI 53233 PHONE: 414-224-1100	
		STATE OF WISCONSIN DEPARTMENT OF TRANSPORTATION ACCEPTED	
	02/13/24	DATE	
STRUCTURE S-67-308			
HS 94 NB, AT GORE TO CH 15 EXIT			
COUNTY: WAUKESHA			
DESIGN SPEC: ASHFD BRIDGE DESIGN SPECIFICATIONS			
DESIGNED BY:	TR:	CHKD BY:	TR:
DRAWN BY:	TR:	CHKD BY:	TR:
GENERAL PLAN			SHEET 1 OF 1
			7731

STATE PROJECT NUMBER  
1060-47-70

**GENERAL NOTES:**

DRAWINGS SHALL NOT BE SCALED  
ALL HS, BOLTS, NUTS, AND WASHERS SHALL BE GALVANIZED PER SECTION 6411 OF THE WISDOT STANDARD SPECIFICATIONS.  
EXISTING SIGN DESIGN AREA FROM HS IS 220 S.F.  
CATWALK REPAIR INCLUDES REPLACING THE GRATING AND SAFETY CHAINS.

**TRAFFIC DATA:**

IH 94 A.A.D.T. = 79,900 (2019)  
IH 94 A.A.D.T. = 96,465 (2043)  
R.D.S. = 70 MPH

Addendum No. 01  
ID 1060-47-70  
Added Sheet 773J  
March 25, 2024

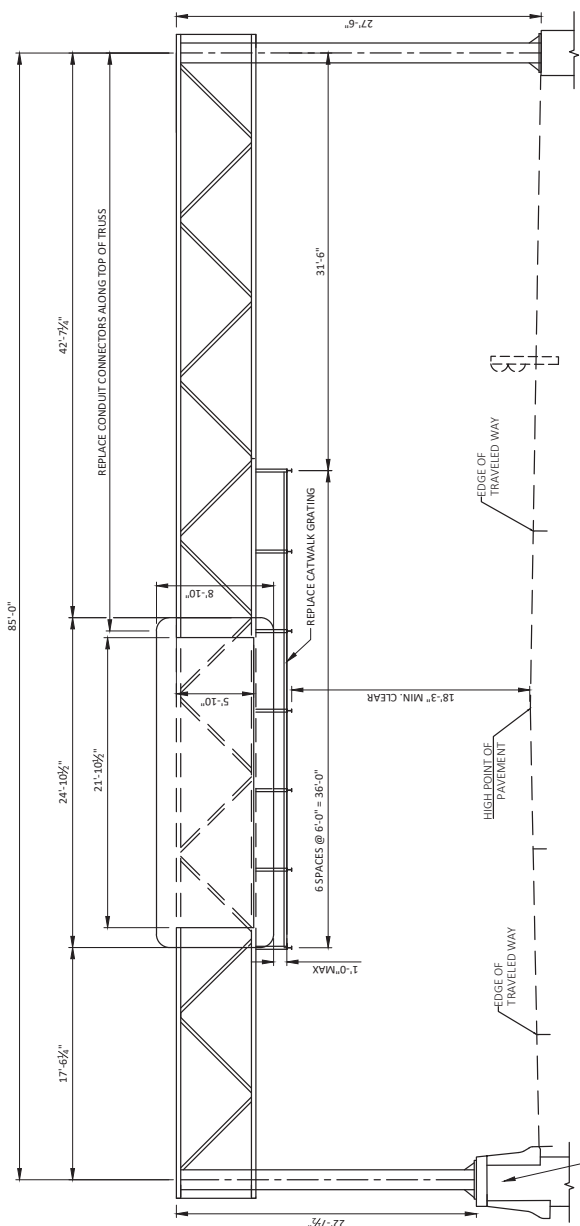

S-67-406  
ELEVATION VIEW LOOKING EAST



DESIGN CONSULTANT  
TOM ROMENSKO, PE  
(808) 568-1370

BRIDGE OFFICE CONTACT  
MARCUSONK, PE  
(808) 281-0281

PROJECT SCALE: 0.388128

TOTAL ESTIMATED QUANTITIES		
ITEM NUMBER	BID ITEM	UNIT TOTAL
SPV.0080.11	CATWALK REPAIR	EA 1
SPV.0080.12	REPLACE CONDUIT CONNECTOR	EA 6

NO.	DATE	REVISION	BY

DAAR ENGINEERING, INC.  
1000 W. WISCONSIN AVENUE  
MADISON, WI 53706  
PHONE: 608.261.1200

STATE OF WISCONSIN  
DEPARTMENT OF TRANSPORTATION  
ACCEPTED: *[Signature]* SPR DATE: 02/17/23  
CHIEF STRUCTURES DESIGN ENGINEER

STRUCTURE S-67-406

IH 94 WB AT GORE TO CH S EXIT  
COUNTY: WAUKESHA  
DESIGN SPEC: TOWN/PROJECT/ROUTE  
ASSISTED BRIDGE DESIGN SPECIFICATIONS  
DESIGNED BY: MC TR BY: MC TR  
DRAWING CADD: MC TR

GENERAL PLAN  
SHEET 1 OF 1  
773J

LAYOUT: 1 - GENERAL PLAN

STATE PROJECT NUMBER  
1060-47-70

**TRAFFIC DATA**

IH 94  
AADT (2043) \_\_\_\_\_ 96,465  
DESIGN SPEED \_\_\_\_\_ 70 MPH

**LIST OF DRAWINGS:**

1. GENERAL NOTES AND DESIGN DATA
2. GENERAL LAYOUT

**LIST OF STANDARD DESIGN DRAWINGS**

3. I. 4-CHORD TRUSS FULL SPAN TRUSS DETAILS
4. II. 4-CHORD TRUSS FULL SPAN CONNECTIONS 1
5. III. 4-CHORD TRUSS FULL SPAN CONNECTIONS 2
6. IV. 4-CHORD TRUSS FULL SPAN CONNECTIONS 3
7. V. 4-CHORD TRUSS FULL SPAN CONNECTIONS 4
8. VI. 4-CHORD TRUSS FULL SPAN ELECTRICAL DETAILS
9. VII. 4-CHORD TRUSS FULL SPAN FOUNDATIONS 1
10. VIII. 4-CHORD TRUSS FULL SPAN FOUNDATIONS 2

**Addendum No. 01  
ID 1060-47-70  
Added Sheet 773K  
March 25, 2024**

**GENERAL NOTES**

DRAWINGS SHALL NOT BE SCALED.  
ALTERNATE DESIGNS ARE NOT ALLOWED.  
COORDINATES ON THE PLANS ARE REFERENCED TO THE WISCONSIN COUNTY COORDINATE SYSTEM (WCCS), WALKER COUNTY ZONE, MAD 83 (2011). ALL STATIONS AND ELEVATIONS ARE IN FEET. ELEVATIONS ARE REFERENCED TO THE NORTH AMERICAN VERTICAL DATUM NAVD 88 (2012).  
ALL DIMENSIONS ARE IN ENGLISH UNITS. THE FIRST DIGIT OF A THREE-DIGIT BAR MARK OR THE FIRST TWO DIGITS OF A FOUR-DIGIT BAR MARK SIGNIFIES THE BAR SIZE.  
SIGN BRIDGE ID PLAQUES SHALL BE CONSIDERED INCIDENTAL TO THE BID ITEM "TRUSS FULL SPAN 4-CHORD (TYPE)" FOR EACH APPLICABLE SIGN STRUCTURE IN THE PLAN SET. LOCATE THE ID PLAQUE ON THE TRUSS FULL SPAN 4-CHORD (TYPE) SIGN STRUCTURE FROM THE ROADWAY.  
FABRICATE AND INSTALL THE ID PLAQUE IN ACCORDANCE WITH S.D.D. 12A.4.3.  
CATWALKS ARE USED ON 4-CHORD STRUCTURES CARRYING DMS SIGNS. CATWALKS SHALL BE IDENTIFIED TO THE BID ITEM "TRUSS FULL SPAN 4-CHORD (TYPE)" FOR EACH DMS SIGN STRUCTURE IN THE PLAN SET.  
UNLESS DETAILED OTHERWISE IN THE PLANS, ALL H.S. BOLTED CONNECTIONS SHALL BE MADE WITH 3/4" DIA A325 GALVANIZED BOLTS. FIELD CONNECTIONS SHALL BE INSTALLED WITH DTI WASHERS.  
WELDED CONNECTIONS CAN BE USED IN LIEU OF BOLTED CONNECTIONS, IF A TRUSS UNIT CAN BE GALVANIZED IN ONE PIECE.  
WELD TEST AS PER AWS D1.1.  
SEE SIGN PLATE NO. A4-6, A4-7A & A4-7B OF THE SIGN PLATE MANUAL FOR INSTRUCTIONS ON CENTERING SIGNS VERTICALLY ON THE TRUSS.  
SIGNS OR BLANKS SHALL BE INSTALLED ON TRUSS AT TIME OF ERECTION. BLANKS SHALL BE 1/4 THE LENGTH OF THE CANTILEVER SPAN, 2'-0" DEEPER THAN THE E/C/L OF CHORDS, AND SHALL BE CENTERED ON THE BRIDGE. SIGNS SHALL BE AS DESIGNATED ON THE PLANS.  
THE INFORMATION SHOWN ON THESE DRAWINGS CONCERNING TYPE AND LOCATION OF UNDERGROUND UTILITIES IS NOT GUARANTEED TO BE ACCURATE OR ALL-INCLUSIVE. THE CONTRACTOR IS RESPONSIBLE FOR MAKING HIS OWN DETERMINATION OF THE TYPE AND LOCATION OF UTILITIES AS MAY BE NECESSARY TO AVOID DAMAGE.  
CONTRACTOR SHALL SUBMIT SHOP DRAWINGS PER THE REQUIREMENTS IN THE STANDARD SPECIFICATIONS PRIOR TO FABRICATION OF THE STRUCTURE. CONTRACTOR SHALL SHOW SIGNS ON THE SHOP DRAWINGS.  
THE CONTRACTOR SHALL BE RESPONSIBLE FOR DRILLING OR EXCAVATING AND MAINTAINING A STABLE AND OPEN HOLE FOR SUBSEQUENT INSTALLATION OF CONCRETE MASONRY FOR THE DRILLED SHAFTS PARTIAL OR FULL DEPTH TEMPORARY CASING MAY BE REQUIRED TO MAINTAIN THE STABILITY OF THE EXCAVATED HOLE FOR THE SIGN SUPPORT PRIOR TO FILLING THE HOLE WITH CONCRETE. PERMANENT CASING MADE FROM STEEL OR CORRUGATED METAL PIPE MAY BE USED IN LIEU OF TEMPORARY CASING PROVIDED THAT THE CASING IS PROPERLY BRACED AND SHIELDING IS PROVIDED TO PREVENT DRILLING SHAFTS 38-INCH.

**DESIGN DATA**

DESIGNED ACCORDING TO THE ASHTO "LRFD SPECIFICATIONS FOR STRUCTURAL SUPPORTS FOR HIGHWAY SIGNS, LUMINAIRES, AND TRAFFIC SIGNALS", 1ST EDITION AND INTERIM SPECIFICATIONS, AND THE WISDOT BRIDGE MANUAL.  
FOUNDATION DESIGNED ACCORDING TO THE ASHTO LRFD BRIDGE DESIGN SPECIFICATIONS, 8TH EDITION.  
DEAD LOAD: W.T. OF DMS SIGN AND SUPPORTING STRUCTURE.  
WIND PRESSURE: 120 MPH (3.5 SEC. GUST SPEED) TO SIGN AREA & EXPOSED MEMBERS.  
FOUNDATION MEAN RECURRENCE INTERVAL

WIND COMPONENTS	NORMAL	TRANSVERSE
LOAD CASE 1:	0.00	1.00
LOAD CASE 2:	0.00	0.75
LOAD CASE 3:	0.75	0.75

LOAD COMBINATIONS  
STRENGTH (1.25DC + 1.6L)  
EXTREME (1.1DC + 1.0W + 1.0 ICE)  
SERVICE I (MIN DC):  
SERVICE II (MIN DC):  
FATIGUE I:  
1.0 TRG (TRUCK INDUCED GUST VIBRATION)  
1.0 TRG (TRUCK INDUCED GUST VIBRATION)

**MATERIAL PROPERTIES**

CONCRETE MASONRY \_\_\_\_\_  $f_c = 3,500$  PSI  
HIGH STRENGTH BAR STEEL REINFORCEMENT, GRADE 60 \_\_\_\_\_  $f_y = 60,000$  psi  
STRUCTURAL ANGLES, PLATES, AND BARS - ASTM A709 GRADE 36 \_\_\_\_\_  $f_y = 36,000$  psi  
CHORDS & COLUMN PIPE - ASTM 500 GRADE C \_\_\_\_\_  $f_y = 46,000$  psi  
HIGH STRENGTH BOLTS - A325 \_\_\_\_\_  $f_y = 92,000$  psi  
ANCHOR RODS - ASTM F1554 GRADE 55 \_\_\_\_\_  $f_y = 55,000$  psi  
HEAVY HEX NUTS FOR ANCHOR RODS - ASTM A563A  
WASHERS FOR ANCHOR RODS = ASTM F436

**FOUNDATION DATA**

ALL DRILLED SHAFTS AND SUPPORTS ON DRILLED SHAFTS THAT HAVE BEEN DESIGNED FOR STEEL SOILS SHALL BE EITHER PRECAST OR EQUAL TO 24" (600 MM) DIAMETER OR A COHESION VALUE GREATER THAN OR EQUAL TO 750 PSF (COHESIVE SOILS) AND A UNIT WEIGHT OF 125 PCF. THE GROUND WATER TABLE IS ASSUMED TO BE AT A DEPTH OF 10'-0" BELOW THE GROUND SURFACE. ACTUAL WATER LEVEL AT THE SITE MAY VARY. THE REGION GEOTECHNICAL ENGINEER SHALL BE CONSULTED FOR THE PROPERTIES OF THE SOILS AND THE CONTRACTOR SHALL CONFIRM THESE PROPERTIES PRIOR TO PLACEMENT OF THE DRILLED SHAFT CONCRETE.

**TOTAL ESTIMATED QUANTITIES**

BID ITEM NO.	BID ITEM	UNIT	S-67-420
531.2096	DRILLING SHAFT 36-INCH	LF	88
531.6120.001	FOUNDATION TWO-SHAFT TYPE FF-II S-67-420	EA	1
532.6120.001	TRUSS FULL SPAN 4-CHORD TYPE II S-67-420	EA	1

**STRUCTURE DATA**

SIGN STR S-67-420  
ACTUAL SIGN AREA 193 SF  
ACTUAL SIGN DEPTH 7'-10"  
DMS WEIGHT 3,300 LB.  
TYPE II  
STANDARD DESIGN TRUSS



NO.	DATE	REVISION	BY

DAAR ENGINEERING, INC.  
www.daarcorp.com  
414-225-9817  
414-225-9817  
STATE OF WISCONSIN  
DEPARTMENT OF TRANSPORTATION  
ACCEPTED  
02/13/24  
UNIT

STRUCTURE S-67-420  
COUNTY WALKER  
DESIGN SPEC. ROAD BRIDGE PLACES/REGULATIONS  
BY DESIGNED MC LTD. TR BY DRAWN MC LTD. TR  
PLANS SHEET 1 OF 10  
GENERAL NOTES & DESIGN DATA 773K

DESIGN CONSULTANT  
TOM ROMNESKO, PE  
(608) 596-1370  
BRIDGE OFFICE CONTACT  
AARON BONK, PE  
(608) 281-0281  
PROJECT: MITCHELL CORNER  
PILOT BY: MITCHELL CORNER  
SCALE: 1" = 36'-0"

STATE PROJECT NUMBER  
1060-47-70

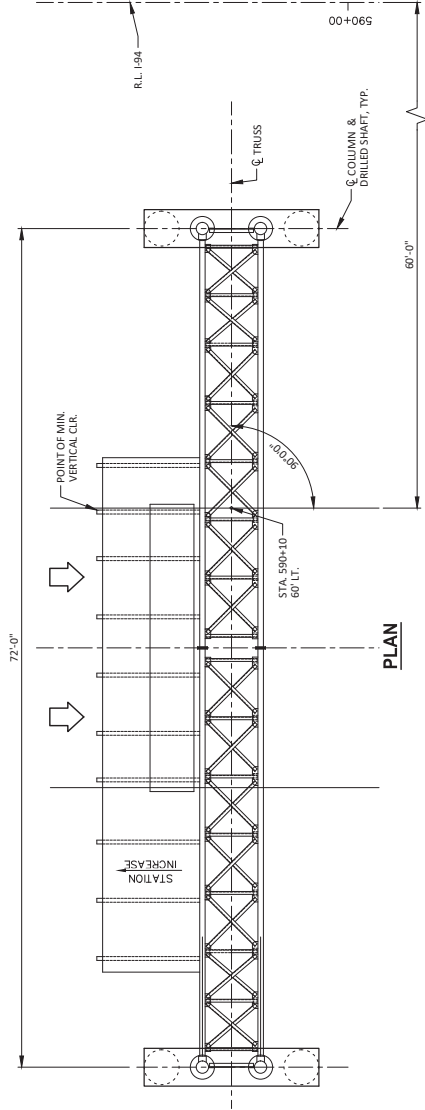

PLAN

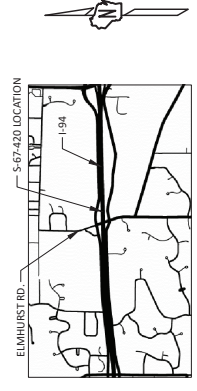

LOCATION MAP

**NOTE**  
POINT OF MIN. VERTICAL CLEARANCE  
STA. 590+10, 60.00' LEFT  
EL. 897.46

**LEGEND**  
☆ ELEVATIONS GIVEN ALONG C. TRUSS  
⊙ SIGN NUMBERS (PERMANENT SIGNING PLAN)

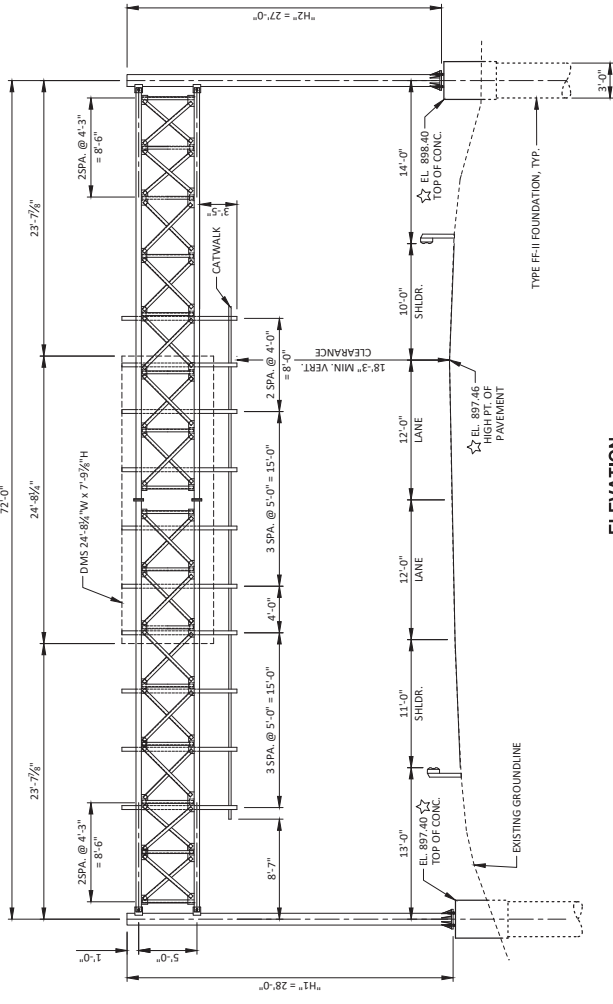

ELEVATION

I-94 WESTBOUND - EAST OF ELMHURST ROAD  
STA. 590+10  
(LOOKING UPSTATION AT BACK OF SIGN)

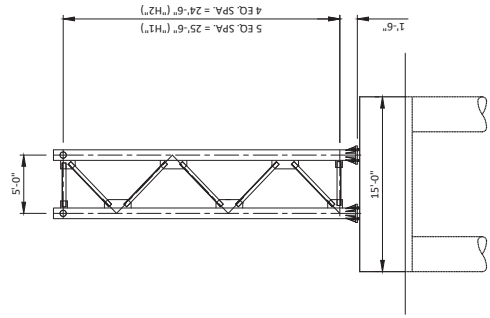

END VIEW  
(LOOKING NORTH)

Addendum No. 01  
ID 1060-47-70  
Added Sheet 773L  
March 25, 2024

NO.	DATE	REVISION	BY
STATE OF WISCONSIN DEPARTMENT OF TRANSPORTATION			
STRUCTURE S-67-420			
DRAWN BY		PLANS	
TR		C&D, MC	
SHEET 2 OF 10			
GENERAL LAYOUT			
773L			

\$\$\$...plattigdate...\$\$\$

\$\$\$...designflr...\$\$\$

STATE PROJECT NUMBER  
**STANDARD**

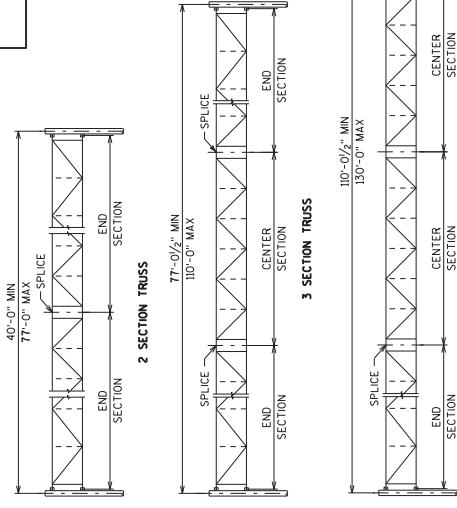
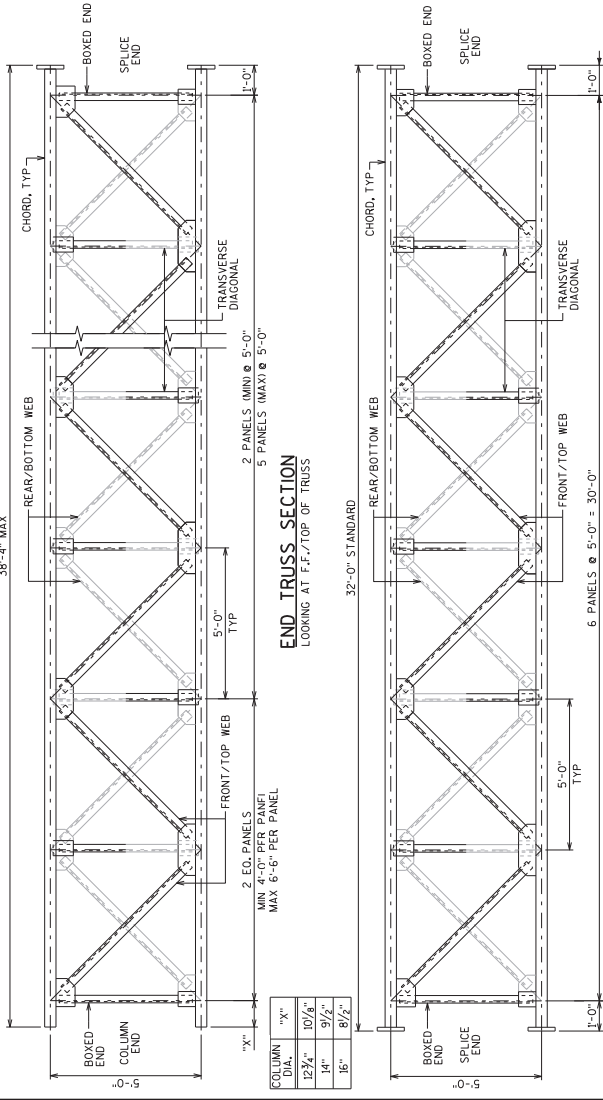

**TRUSS CONFIGURATIONS**  
TRUSS SYMMETRICAL ABOUT C<sub>L</sub> OF SPAN

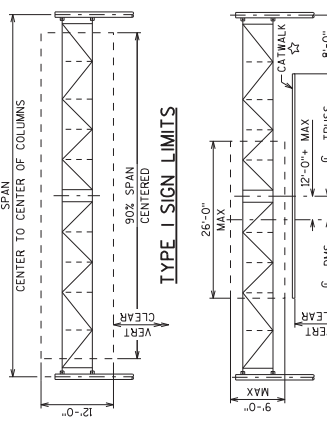

INTERPOLATE FOR VALUES NOT SHOWN  
DMS VALUES INCLUDE DL OF CATWALK.

CAMBER VALUES	
SPAN "L"	DMS "y"
60'-0"	1"
82'-0"	1 1/4"
102'-0"	1 7/8"
118'-0"	2 1/8"
130'-0"	2 3/4"

**CAMBER DIAGRAM**  
CAMBER SHALL BE BUILT INTO THE TRUSS DURING FABRICATION. SHIM PLATES BETWEEN TRUSS SECTIONS TO CREATE CAMBER SHALL NOT BE ALLOWED.

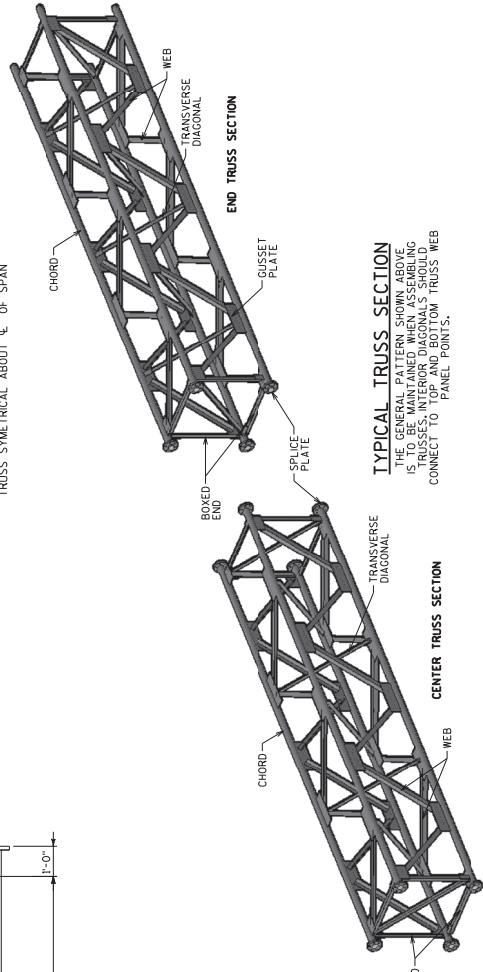

**FULL SPAN 4-CHORD TRUSS MEMBER TABLE**

STANDARD DESIGN TRUSS	TYPE I SIGN AREA (F <sup>2</sup> )	DMS AREA (F <sup>2</sup> )	MAXIMUM SPAN RANGE	CHORD OUTER DIA. X THK	WEB W X D X THK	TRANSVERSE DIAGONAL W X D X THK	SPLICE PLATE OUTER DIA. X THK	CHORD SPLICE NO. 7/4 BOLTS
I	648	234	60'-0"	5.563" X 0.258"	L3X3X3/4	L3X3X3/4	1" X 1/2"	8
II	885	234	82'-0"	5.563" X 0.375"	L3X3X3/4	L3X3X3/4	1 1/8" X 1/2"	8
III	1022	234	102'-0"	5.563" X 0.500"	L4X4X3/4	L3X3X3/4	1 1/8" X 1/2"	8
IV	1232	234	114'-0"	6.625" X 0.375"	L4X4X3/2	L3X3X3/4	1'-0 1/8" X 1/2"	8
V	1404	234	130'-0"	6.625" X 0.500"	L4X4X3/2	L3X3X3/4	1'-0 1/8" X 1/2"	8

**Addendum No. 01**  
**ID 1060-47-70**  
**Added Sheet 773M**  
**March 25, 2024**

**LEGEND**  
\*FOR OSS WITH DMS ONLY. SEE 'CATWALK DETAILS' SHEET

**4-CHORD TRUSS FULL SPAN TRUSS DETAILS**  
773M

NO.	DATE	REVISION	BY
STATE OF WISCONSIN DEPARTMENT OF TRANSPORTATION STRUCTURES DESIGN SECTION			
UPDATED:		MARCH 2021	
BY:	BRUN	BOB	BOB
SHEET 1 OF VIII			



STATE PROJECT NUMBER

STANDARD

**NOTE**

FABRICATOR HAS THE OPTION TO USE NON-MITERED, FULL PENETRATING GUSSET PLATES IN ALL OF THE PLATES SHOWN ON THESE DETAILS.

**MEMBER CONNECTION DATA**

STANDARD CONNECTION TYPE	WELD LEG LENGTH	NO. OF BOLTS
I	3" MIN	4" MIN
II	3/2" MIN	6" MIN
III	3/2" MIN	6" MIN
IV	4" MIN	6 1/4" MIN
V	4 1/2" MIN	7 1/4" MIN

FOR ALL ANGLE TO GUSSET CONNECTIONS, BOLT SPACING = 2 1/2"

**ANGLE DATA**

ANGLE SIZE	"x"	"y"
L3X3X1/2	0.836"	1 1/4"
L3/2X3/2X3/8	0.379"	1 1/2"
L3/2X3/2X3/8	1.00"	1 1/2"
L4X4X3/8	1.13"	1 1/2"
L4X4X1/2	1.15"	1 1/2"
L4X4X1/2	1.18"	1 1/2"
L5X5X1/2	1.40"	2"
L5X5X1/2	1.42"	2"

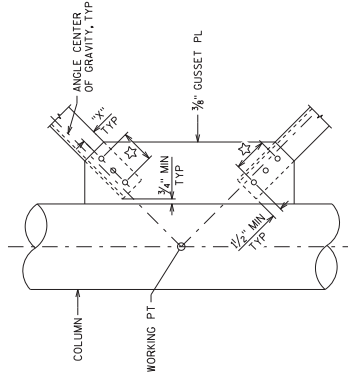
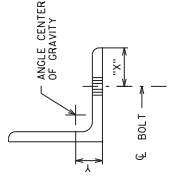

**BOLTED COLUMN WEB CONNECTION**

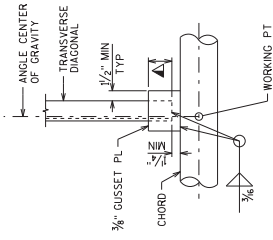

**WELDED TRANSVERSE DIAGONAL CONNECTION**

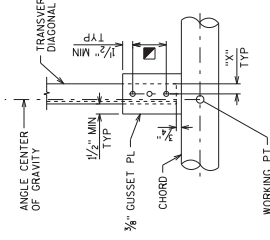

**BOLTED TRANSVERSE DIAGONAL CONNECTION**

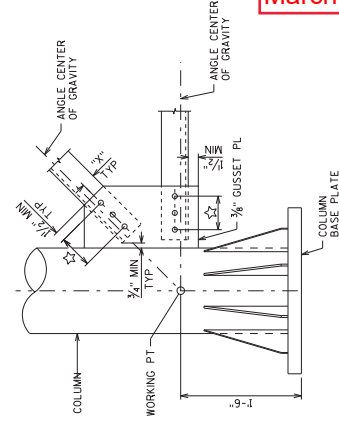

**BOLTED COLUMN BOTTOM CONNECTION**

TOP CONNECTION SIMILAR

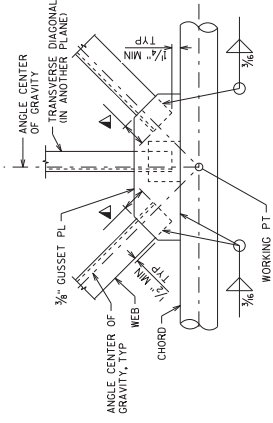

**WELDED PANEL CONNECTION**

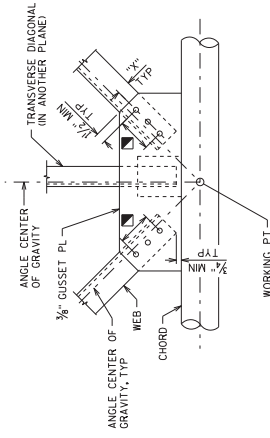

**BOLTED PANEL CONNECTION**

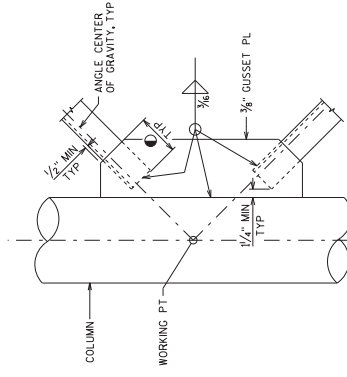

**WELDED COLUMN WEB CONNECTION**

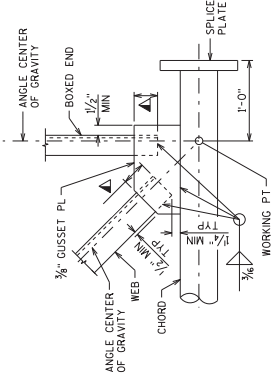

**WELDED BOXED END CONNECTION**

CONNECTION SHOWN AT CHORD SPLICE. CONNECTION AT COLUMN END SIMILAR

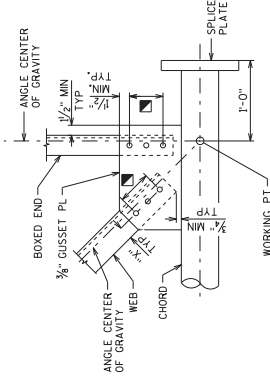

**BOLTED BOXED END CONNECTION**

CONNECTION SHOWN AT CHORD SPLICE. CONNECTION AT COLUMN END SIMILAR

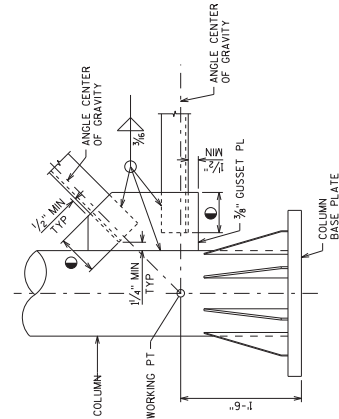

**WELDED COLUMN BOTTOM CONNECTION**

TOP CONNECTION SIMILAR

Addendum No. 01  
ID 1060-47-70  
Added Sheet 7730  
March 25, 2024

NO.	DATE	REVISION	BY
STATE OF WISCONSIN DEPARTMENT OF TRANSPORTATION STRUCTURES DESIGN SECTION			
UPDATED:		MARCH 2021	
BY:	BRUNN	DESIGNED BY:	BOS
4-CHORD TRUSS FULL SPAN CONNECTIONS 1		SHEET III OF VIII	
		7730	







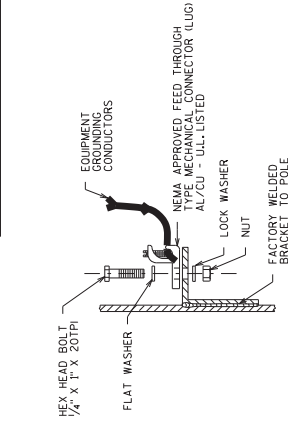

**GROUNDING LUG DETAIL**  
 NUT, BOLT, AND WASHERS SHALL BE STAINLESS STEEL

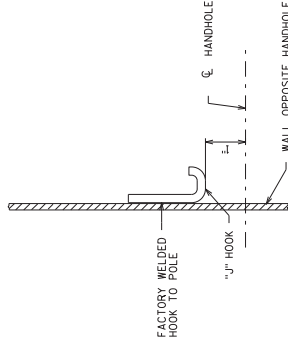

**TYPICAL "J" HOOK LOCATION**

THE "J" HOOK SHALL BE FACTORY WELDED TO THE INSIDE OF ALL COLUMNS CONTAINING ELECTRICAL WIRING. THE "J" HOOK SHALL BE ATTACHED ABOVE THE CENTERLINE OF THE UPPER HANDLE AND MOUNTED DIRECTLY OPPOSITE THE HANDLE AS SHOWN IN THE DRAWING.

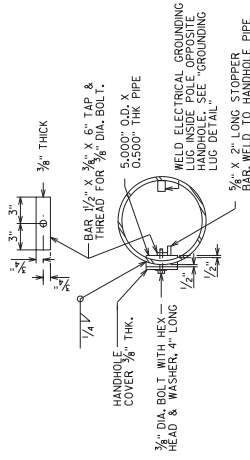

**HANDHOLE NOTES**

HANDHOLES SHALL BE LOCATED IN ONE COLUMN OF THE SIGN BRIDGE STRUCTURE IF ELECTRICALLY OPERATED DEVICES ARE INSTALLED ON/IN THE STRUCTURE. COLUMNS WITH ELECTRICAL DEVICES SHALL BE IDENTIFIED AS SUCH. VERIFY THE LOCATION OF THE ELECTRICAL SERVICE ENTRANCE WITH THE REGION TRAFFIC SECTION PRIOR TO FABRICATION OF THE SIGN BRIDGE COLUMNS AND MEMBERS. CONDUIT (AS REQ'D.) SHALL BE LOCATED, PLACED AND SIZED AS SHOWN ON THE ELECTRICAL PLAN SHEETS.

UNLESS NOTED OTHERWISE, ALL HANDHOLE ELEMENTS TO BE GALVANIZED PER THE WISDOT STANDARD SPECIFICATIONS.

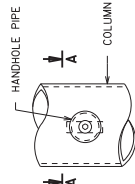

**HANDHOLE DETAILS**

Addendum No. 01  
 ID 1060-47-70  
 Added Sheet 773R  
 March 25, 2024

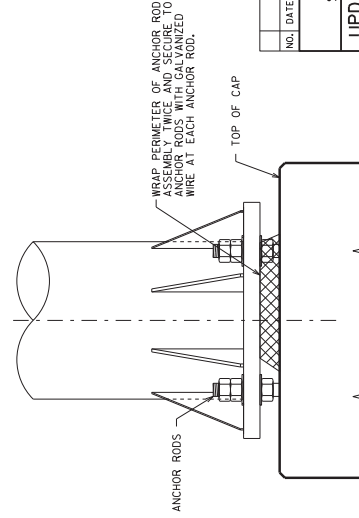

(ONLY REQ'D. WHEN ELECTRICAL DEVICES ARE INSTALLED)

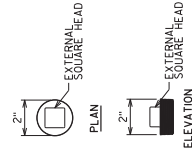

**CONDUIT PLUG DETAILS**

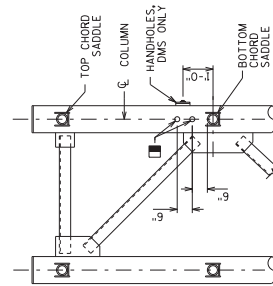

**CONDUIT HOLE LOCATIONS**

2" THREADED HOLE USE THREADED CONDUIT PLUG FOR UNUSED HOLES

NO.	DATE	REVISION	BY
STATE OF WISCONSIN DEPARTMENT OF TRANSPORTATION STRUCTURES DESIGN SECTION			
UPDATED: MARCH 2021			
DRAWN BY: GRAMIN BOS (C.D.)		CHECKED BY: BOS	
SHEET VI OF VIII			773R



NOTE: THE FIRST OR FIRST TWO DIGITS OF THE BAR MARK SIGNIFIES THE BAR SIZE

**BILL OF BARS - STANDARD DESIGN TYPE J**

BAR MARK	NO. REOD.	LENGTH	BENT	BAR SERIES	LOCATION
A401	56	24'-2"			DRILLED SHAFT - VERTICAL
A402	80	9'-0"	X		DRILLED SHAFT - HORIZONTAL
A603	X 12	13'-3"	X		CAP - LONGITUDINAL - BOTTOM
A604	X 36	11'-8"	X		CAP - LONGITUDINAL - TOP & SIDES
A605	X 48	14'-10"	X		CAP - STIRRUP
A406	X 16	5'-2"	X		CAP - VERTICAL - EACH END
A407	X 16	3'-5"	X		CAP - HORIZONTAL - EACH END

**BILL OF BARS - STANDARD DESIGN TYPE II**

BAR MARK	NO. REOD.	LENGTH	BENT	BAR SERIES	LOCATION
A401	56	24'-2"			DRILLED SHAFT - VERTICAL
A402	92	9'-0"	X		DRILLED SHAFT - HORIZONTAL
A603	X 12	16'-3"	X		CAP - LONGITUDINAL - BOTTOM
A604	X 36	14'-8"	X		CAP - LONGITUDINAL - TOP & SIDES
A605	X 60	14'-10"	X		CAP - STIRRUP
A406	X 16	5'-2"	X		CAP - VERTICAL - EACH END
A407	X 16	3'-5"	X		CAP - HORIZONTAL - EACH END

**BILL OF BARS - STANDARD DESIGN TYPE III**

BAR MARK	NO. REOD.	LENGTH	BENT	BAR SERIES	LOCATION
A401	56	25'-9"			DRILLED SHAFT - VERTICAL
A402	96	10'-6"	X		DRILLED SHAFT - HORIZONTAL
A703	X 12	17'-1"	X		CAP - LONGITUDINAL - BOTTOM
A604	X 36	15'-2"	X		CAP - LONGITUDINAL - TOP & SIDES
A605	X 62	15'-10"	X		CAP - STIRRUP
A406	X 16	5'-2"	X		CAP - VERTICAL - EACH END
A407	X 16	3'-11"	X		CAP - HORIZONTAL - EACH END

**BILL OF BARS - STANDARD DESIGN TYPE IV**

BAR MARK	NO. REOD.	LENGTH	BENT	BAR SERIES	LOCATION
A401	56	25'-9"			DRILLED SHAFT - VERTICAL
A402	120	10'-6"	X		DRILLED SHAFT - HORIZONTAL
A703	X 12	20'-1"	X		CAP - LONGITUDINAL - BOTTOM
A604	X 36	18'-2"	X		CAP - LONGITUDINAL - TOP & SIDES
A605	X 74	15'-10"	X		CAP - STIRRUP
A406	X 16	5'-2"	X		CAP - VERTICAL - EACH END
A407	X 16	3'-11"	X		CAP - HORIZONTAL - EACH END

**BILL OF BARS - STANDARD DESIGN TYPE V**

BAR MARK	NO. REOD.	LENGTH	BENT	BAR SERIES	LOCATION
A1001	56	26'-5"			DRILLED SHAFT - VERTICAL
A402	96	12'-1"	X		DRILLED SHAFT - HORIZONTAL
A703	X 12	20'-7"	X		CAP - LONGITUDINAL - BOTTOM
A604	X 36	18'-8"	X		CAP - LONGITUDINAL - TOP & SIDES
A605	X 76	16'-10"	X		CAP - STIRRUP
A406	X 16	5'-2"	X		CAP - VERTICAL - EACH END
A407	X 16	4'-5"	X		CAP - HORIZONTAL - EACH END

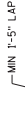

DESIGN TYPE	"A"
I	2'-5"
II	2'-5"
III	2'-11"
IV	2'-11"
V	3'-5"

DESIGN TYPE	"B"
I	A603 11'-7"
II	A603 14'-7"
III	A703 15'-1"
IV	A703 18'-1"
V	A703 18'-7"

DESIGN TYPE	"C"
I	2'-11"
II	2'-11"
III	3'-5"
IV	3'-5"
V	3'-11"

DESIGN TYPE	"D"
I	2'-9 1/2"
II	2'-9 1/2"
III	3'-3 1/2"
IV	3'-3 1/2"
V	3'-9 1/2"

**BAR BENDING DIAGRAMS**

NOTE: ALL DIMENSIONS ARE OUT TO OUT OF BAR. THE FIRST OR FIRST TWO DIGITS OF A BAR MARK SIGNIFIES THE BAR SIZE.

**ESTIMATED QUANTITIES - FOUNDATION**

STANDARD TRUSS DESIGN	CONCRETE MATERIAL (CY)	STEEL REINFORCEMENT (LBS)	STEEL REINFORCEMENT HS (#)	STEEL REINFORCEMENT HS (LBS)	ANCHOR ASSEMBLY (EACH)	ANCHOR ASSEMBLY (EACH)	FOUNDATION DIMENSION (LBS)
I	33	4,100	2,030	4	4	76	36" x 42" x 48" DIA. DIA. DIA.
II	40	4,170	2,520	4	4	88	76
III	53	5,580	2,810	4	4	92	88
IV	56	5,750	3,340	4	4	92	92
V	70	7,160	3,540	4	4	92	92

\*\* \* QUANTITIES ARE FOR INFORMATION ONLY AND ARE BASED ON STANDARD STRUCTURE DIMENSIONS\*\*

Addendum No. 01  
ID 1060-47-70  
Added Sheet 773T  
March 25, 2024

NO.	DATE	REVISION	BY
STATE OF WISCONSIN DEPARTMENT OF TRANSPORTATION STRUCTURES DESIGN SECTION			
UPDATED:		MARCH 2021	PLANS: BOS
		BY: BOS	
4-CHORD TRUSS FULL SPAN FOUNDATIONS 2			SHEET VIII OF VIII
			773T

STATE PROJECT NUMBER  
1060-47-70

**GENERAL NOTES:**

- DRAWINGS SHALL NOT BE SCALED
- ALTERNATE DESIGNS ARE NOT ALLOWED
- ALL HS, BOLTS, NUTS, AND WASHERS SHALL BE GALVANIZED PER SECTION 641 OF THE WISDOT STANDARD SPECIFICATIONS.
- EXISTING SIGN DESIGN AREA FROM HSS IS 30 S.F.
- STEEL ANCHOR ROD NUTS AND WASHERS SHALL BE ASTM A-576.

**TRAFFIC DATA:**

STM 318 A.A.D.T. = 9,400 (2019)  
R.D.S. = 40 MPH

**MATERIAL PROPERTIES**

- STRUCTURAL ANGLES  
PLATE AND BARS - ASTM A709 GRADE 36  
fy = 36,000 psi
- HIGH STRENGTH BOLTS - A 325  
fy = 92,000 psi
- ANCHOR RODS - ASTM F1554 GRADE 55  
fy = 55,000 psi
- HEAVY HEX NUTS FOR ANCHOR RODS - ASTM A563A
- WASHERS FOR ANCHOR RODS - ASTM F436

Addendum No. 01  
ID 1060-47-70  
Added Sheet 773U  
March 25, 2024

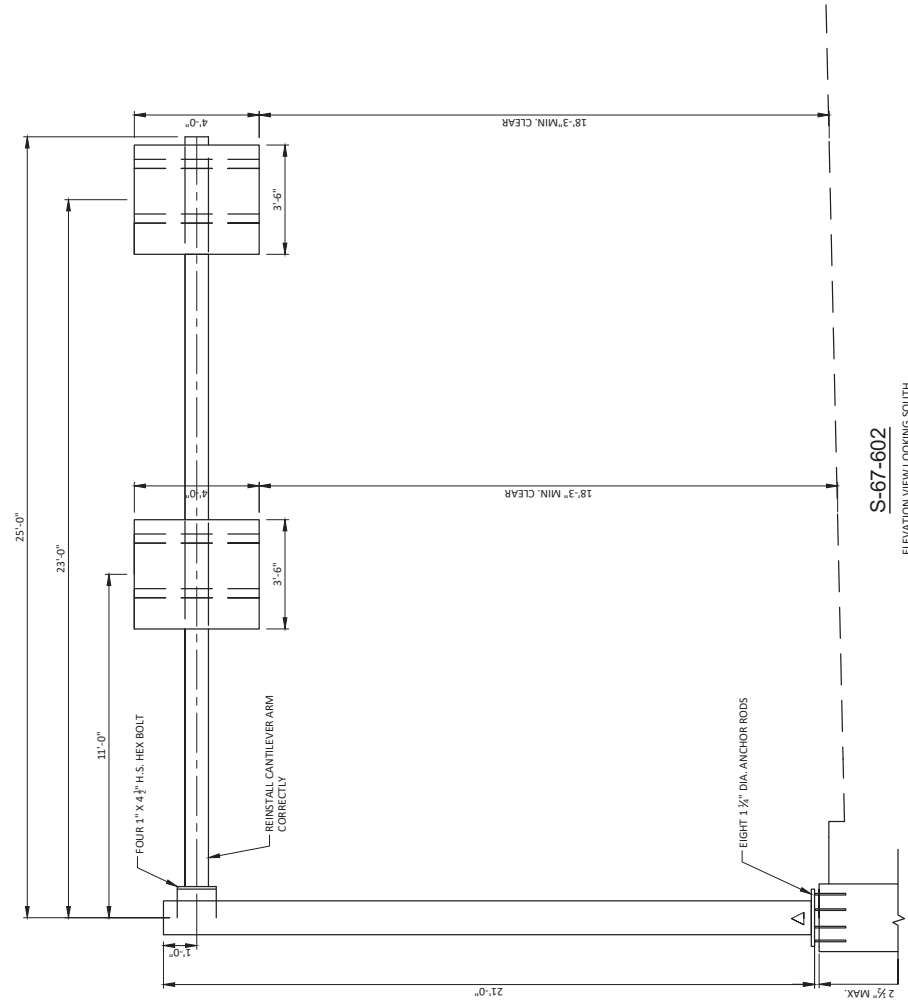

S-67-602  
ELEVATION VIEW LOOKING SOUTH

TOTAL ESTIMATED QUANTITIES			
ITEM NUMBER	BID ITEM	UNIT	TOTAL
SPV.0060.001	TENSION ANCHOR ROD	EA	8
SPV.0060.007	LOWER STRUCTURE	EA	1

△ REMOVE MAST ARM AND COLUMN. LOWER BASE PLATE TO 2 1/2" MAX. FROM TOP OF CONCRETE TO BOTTOM OF BASE PLATE. REMOVE LOCK WASHERS

NO.	DATE	REVISION	BY
 DAK ENGINEERING, INC. 1000 W. WISCONSIN ST. SUITE 100 WAUKESHA, WI 53186			
STATE OF WISCONSIN DEPARTMENT OF TRANSPORTATION		ACCEPTED  AARON BONK, PE CHIEF STRUCTURES DESIGN ENGINEER	
STRUCTURE S-67-602		DATE 02/13/24	
5th IS DISTRICT OF SUPERVISOR ID			
COUNTY WAUKESHA		TOWN/WARD/LOCALITY FORTWAHNE	
DESIGN SPEC. ASHFD BRIDGE DESIGN SPECIFICATIONS			
DESIGNED BY	TR.	CHKD BY	TR.
DRAWN BY	MC	CHKD BY	TR.



DESIGN CONSULTANT  
TOM ROMENSKO, PE  
(808) 596-1370

BRIDGE OFFICE CONTACT  
AARON BONK, PE  
(808) 281-0261

**GENERAL PLAN**

SHEET 1 OF 1  
773U

LAYOUT: 1 - GENERAL PLAN

PLOT SCALE: 0.588126

PLOT BY: MITCHELL CORNER

PLOT DATE: 2/28/24 12:22:11 PM



# Wisconsin Department of Transportation

April 5, 2024

**Division of Transportation Systems Development**  
Bureau of Project Development  
4822 Madison Yards Way, 4<sup>th</sup> Floor South  
Madison, WI 53705

Telephone: (608) 266-1631  
Facsimile (FAX): (608) 266-8459

## NOTICE TO ALL CONTRACTORS:

**Proposal #07: 1060-10-71**  
**IH 94 East West Freeway**  
**CTH T and CTH JJ (B-67-240,245)**  
**IH 94**  
**Waukesha County**

**1060-47-70**  
**IH 94 East West Freeway**  
**STH 83 to STH 16**  
**IH 94**  
**Waukesha County**

**1330-47-71**  
**C Delafield, State Road 83**  
**Nagawaukee Park and Ride Lot**  
**Off Sys**  
**Waukesha County**

**2788-03-70**  
**C Waukesha Meadowbrook Road**  
**Rolling Ridge Dr to IH 94 EB Ramps**  
**STH 318**  
**Waukesha County**

## Letting of April 9, 2024

This is Addendum No. 02, which provides for the following:

### Special Provisions:

Revised Special Provisions	
Article No.	Description
45	Culvert Pipe Liners 18-Inch, Item 520.9700.S.001; Cleaning Culvert Pipes for Liner Verification, Item 520.9750.S.

Deleted Special Provisions	
Article No.	Description
72	Backfill Slurry

**Schedule of Items:**

<b>Revised Bid Item Quantities</b>					
Bid Item	Item Description	Unit	Proposal Total Prior to Addendum	Proposal Quantity Change (-)	Proposal Total After Addendum
209.1100	Backfill Granular Grade 1	CY	476	180	656
305.0110	Base Aggregate Dense 1 1/4-Inch	TON	1596	35	1631
455.0605	Tack Coat	GAL	45,907	10	45,917
465.0125	Asphaltic Surface Temporary	TON	2144	64	2208
531.6120	Foundation Two-Shaft Type FF-II (structure) 001. S-67-420	EACH	1	1	2

<b>Deleted Bid Item Quantities</b>					
Bid Item	Item Description	Unit	Proposal Total Prior to Addendum	Proposal Quantity Change (-)	Proposal Total After Addendum
SPV.0035.001	Backfill Slurry	CY	180	-180	0

**Plan Sheets:**

<b>Revised Plan Sheets 1060-47-70</b>	
Plan Sheet	Plan Sheet Title (brief description of changes to sheet)
33	Construction Details – Detail for Installation of Culvert Pipes (Revised backfill material and temporary patch material)
315	Miscellaneous Quantities (Revised bid items Backfill Granular Grade 1 and Base Aggregate Dense 1 1/4-Inch for the cross culverts)
316	Miscellaneous Quantities (Revised bid items Tack Coat and Asphaltic Surface Temporary for the cross culverts)
346	Miscellaneous Quantities (Removed the bid item for Backfill Slurry)
773K	Structure S-67-420 General Notes & Design Data (Revised quantity for Foundation Two-Shaft Type FF-II (structure) 001. S-67-420)

The responsibility for notifying potential subcontractors and suppliers of these changes remains with the prime contractor.

Sincerely,

*Mike Coleman*

Proposal Development Specialist  
Proposal Management Section



**ADDENDUM NO. 02**

**1060-10-71/1060-47-70/1330-47-71/2788-03-70**

**April 5, 2024**

**Special Provisions**

- 45. Culvert Pipe Liners 18-Inch, Item 520.9700.S.001;  
Cleaning Culvert Pipes for Liner Verification, Item 520.9750.S.**

*Replace entire section titled B.3.1 Cement with the following:*

**B.3.1 Cement**

Furnish cement meeting the requirements of standard spec 501.2.4.1 for Type I, II, or I-L Portland Cement.

*Replace entire section titled B.3.3 Sand with the following:*

**B.3.3 Sand**

Furnish natural sand meeting the fine aggregate requirements of standard spec 501.2.7.2 and the size requirements of standard spec 614.2.6 (in ASP 6) except the percent passing the number 200 sieve shall be 0-5 percent by weight.

*Replace the first row of the table in section titled B.3.6 Cellular Grout with the following:*

Cement	ASTM C150 ASTM C595	Type I or II Type I-L
--------	------------------------	--------------------------

- 72. Deleted**

**Schedule of Items**

Attached, dated April 5, 2024, are the revised Schedule of Items Pages 1-37.

**Plan Sheets**

The following 8½ x 11-inch sheets are attached and made part of the plans for this proposal:  
Revised (1060-47-70): 33, 315, 316, 346, and 773K.

END OF ADDENDUM

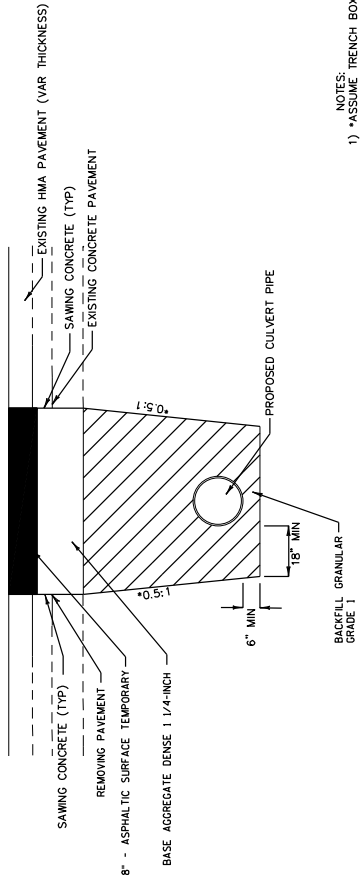

- NOTES
- 1) \*ASSUME TRENCH BOX WILL BE USED
  - 2) 1.5:1 SLOPES ARE REQUIRED FOR OPEN TRENCH.
  - 3) LOCATION TO BE BASE PATCHED WITH SHES CONCRETE PRIOR TO MILL & OVERLAY OPERATIONS
  - 4) BOTTOM OF BASE PATCH TO MATCH BOTTOM OF EXISTING CONCRETE PAVEMENT
  - 5) HMA AND BASE AGGREGATE REMOVAL TO BE PAID AS REMOVING PAVEMENT FOR BASE PATCHING.



DETAIL FOR INSTALLATION OF CULVERT PIPES  
 IH 94 CULVERT CROSSING

Addendum No. 02  
 ID 1016-47-70  
 Revised Sheet 33  
 April 5, 2024

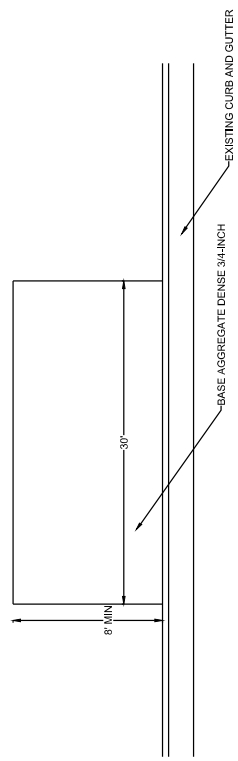

PLAN VIEW

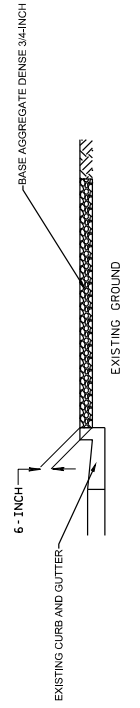

SECTION VIEW

MAINTENANCE PAD DETAIL

PROJECT NO: 1060-47-70	HWY: IH 94	COUNTY: WAUKESHA	CONSTRUCTION DETAILS	SHEET 33	E
FILE NAME: L:\DESIGN PROJECTS\1060-47-00\IH 94 WAUKESHA COUNTY\10. ROADWAY\CADD\SHEETS\PLAN\021001_LD.DWG	PLOT DATE: 4/2/2024 3:45 PM	PLOT BY: TONY BURBITZ	PLOT NAME: 1 IN=10 FT		
LAYOUT NAME: 021001_3.d					



ALL ITEMS ARE CATEGORY 0010 UNLESS OTHERWISE NOTED

ASPHALTIC PAVEMENT

CATEGORY	ROADWAY	STATION	TO	STATION	OFFSET	TACK COAT	GAL	HMA PAVEMENT	TON	3 HT 58-28 H	HMA PAVEMENT	TON	4 SMA 58-28 V	ASPHALTIC	TON	ASPHALTIC RUMBLE	STRIPS, SHOULDER	DIVIDED ROADWAY	LF	
0010	PROJECT ID 1060-47-70																			
	IH 94 EB AND RAMPS	459+30		640+00			9552		7088			10265		350					35800	
	IH 94 WB CROSS CULVERTS	459+30		640+00			10					10575		64					35768	
	IH 94 WB AND RAMPS	459+62		640+00			9739		6872			10575		350						
	IH 94 EB LANE 1/2 JOINT	459+58		640+00			100				119									
	IH 94 WB LANE 1/2 JOINT	459+62		640+00			100				119									
	IH 94 EB AND RAMPS	640+00		676+16			2782		2747		3664			51					7232	
	IH 94 WB AND RAMPS	640+00		676+16			3316		3347		4192			51					7232	
	IH 94 EB AND RAMPS	676+16		707+16			2861		1904		3891			44					6200	
	IH 94 WB AND RAMPS	676+16		707+16			2991		1897		4388			44					6200	
	IH 94 EB AND RAMPS	707+16		732+00			1960		2186		2161			35					4968	
	IH 94 WB AND RAMPS	707+16		732+00			2249		2470		2477			35					4968	
	IH 94 EB AND RAMPS	732+00		794+62			2892		2770		3376			88					8028	
	IH 94 WB AND RAMPS	732+00		794+23			3212		2942		3819			87					8028	
	IH 94 EB LANE 1/2 JOINT	640+00		772+14			74				99									
	IH 94 WB LANE 1/2 JOINT	640+00		772+14			74				99									
	IH 94 EB LANE 2/3 JOINT	640+00		772+14			103		177		88									
	IH 94 WB LANE 2/3 JOINT	640+00		772+14			103		177		88									
	CTH SS	31+00		41+50			301				643									
	STH 318	280+00		291+62			500				1070									
	ASPHALTIC SURFACE LOCATIONS						46													
	ASPHALTIC REPAIR						999				1674									
0130	MEADOWBROOK PARK & RIDE	0A+00		3A+74																
				SUBTOTAL			44242		34577		49422			1199					124424	
0010	PROJECT ID 1330-47-71																			
	NAGAWAUKEE PARK & RIDE	0+18		4+42			614				1050									
				SUBTOTAL			614				1050									
0010	PROJECT ID 2788-03-70																			
	STH 318	268+83		280+00			763				1483									
				SUBTOTAL			763				1483									
				PROJECT ID 1060-47-70 TOTAL			44242		34577		49422			1199					124424	
				PROJECT ID 1330-47-71 TOTAL			614				1050									
				PROJECT ID 2788-03-70 TOTAL			763				1483									
				CONTRACT TOTAL			45619		34577		49422			1199					124424	

Addendum No. 02  
ID 1016-47-70  
Revised Sheet 316  
April 5, 2024

UTILITY LINE OPENING

LOCATION	SPV.0060.057 UTILITY LINE OPENING (ULO)	EACH
<b>PROJECT ID 1060-47-70</b>		
IH 94 EB RAMPS & STH 318	2	
IH 94 WB RAMPS & STH 318	2	
IH 94 EB RAMPS & CTH T	1	
IH 94 WB RAMPS & CTH T	1	
STA 522+00, 162' LT	1	
STA 603+00, 108' LT	1	
STA 633+00, 109' LT	1	
<b>SUBTOTAL</b>	<b>9</b>	
<b>PROJECT ID 2788-03-70</b>		
STH 318 & SILVERNAIL RD	4	
<b>SUBTOTAL</b>	<b>4</b>	
<b>PROJECT ID 1060-47-70 TOTAL</b>	<b>9</b>	
<b>PROJECT ID 2788-03-70 TOTAL</b>	<b>4</b>	
<b>CONTRACT TOTAL</b>	<b>13</b>	

3

ALL ITEMS ARE CATEGORY 0010 UNLESS OTHERWISE NOTED

SECTION CORNERS

ROADWAY	STATION	OFFSET	EACH
<b>PROJECT ID 2788-03-70</b>			
STH 318	275+36	10' RT	1
<b>CONTRACT TOTAL</b>			<b>1</b>

3

BACKFILL SLURRY

CATEGORY	ROADWAY	STATION TO	STATION	OFFSET	COMMENTS
0010	<b>PROJECT ID 1060-47-70</b>				
	IH 94	459+30	465+00		
					CROSS CULVERTS
					0
					0
					<b>CONTRACT TOTAL</b>
					0

REMOVE AND RESET CABLE BARRIER POST

ROADWAY	STATION	OFFSET	EACH
<b>PROJECT ID 1060-47-70</b>			
IH 94	495+06	42' LT	1
<b>CONTRACT TOTAL</b>			<b>1</b>

Addendum No. 02  
ID 1016-47-70  
Revised Sheet 346  
April 5, 2024

MISCELLANEOUS QUANTITIES

PROJECT NO: 1060-47-00, 1330-47-71, 2788-03-70	COUNTY: WAUKESHA	SHEET 346	E
HWY: IH 94	PLOT DATE : 4/4/2024 4:09 PM	PLOT NAME : 030205.mxd	WISDOT / CADDS SHEET 42
FILE NAME :	PLOT BY :	PLOT SCALE : 1,000/00=1,000/000	

STATE PROJECT NUMBER  
1060-47-70

**TRAFFIC DATA**  
IH 94  
AADT (2043) 96,465  
DESIGN SPEED 70 MPH

**LIST OF DRAWINGS:**  
1. GENERAL NOTES AND DESIGN DATA  
2. GENERAL LAYOUT

**LIST OF STANDARD DESIGN DRAWINGS**  
3. I. 4-CHORD TRUSS FULL SPAN TRUSS DETAILS  
4. II. 4-CHORD TRUSS FULL SPAN CONNECTION DETAILS  
5. III. 4-CHORD TRUSS FULL SPAN CONNECTIONS 1  
6. IV. 4-CHORD TRUSS FULL SPAN CONNECTIONS 2  
7. V. 4-CHORD TRUSS FULL SPAN CATWALK DETAILS  
8. VI. 4-CHORD TRUSS FULL SPAN ELECTRICAL DETAILS  
9. VII. 4-CHORD TRUSS FULL SPAN FOUNDATIONS 1  
10. VIII. 4-CHORD TRUSS FULL SPAN FOUNDATIONS 2

**Addendum No. 02**  
**ID 1016-47-70**  
**Revised Sheet 773K**  
**April 5, 2024**

**GENERAL NOTES**  
DRAWINGS SHALL NOT BE SCALED.  
ALTERNATE DESIGNS ARE NOT ALLOWED.  
COORDINATES ON THE PLAN ARE REFERENCED TO THE WISCONSIN COUNTY COORDINATE SYSTEM (WCCS), WALKESHA COUNTY ZONE, MAD 83 (2011). ALL STATIONS AND ELEVATIONS ARE IN FEET. ELEVATIONS ARE REFERENCED TO THE NORTH AMERICAN VERTICAL DATUM NAVD 88 (2012).  
ALL REINFORCING BARS ARE IN BR/50/60 UNITS. THE FIRST DIGIT OF A THREE-DIGIT BAR MARK OR THE FIRST TWO DIGITS OF A FOUR-DIGIT BAR MARK SIGNIFIES THE BAR SIZE.  
SIGN BRIDGE ID PLAQUES SHALL BE CONSIDERED INCIDENTAL TO THE BID ITEM "TRUSS FULL SPAN 4-CHORD (TYPE)" FOR EACH APPLICABLE SIGN STRUCTURE IN THE PLAN SET. LOCATE THE ID PLAQUE TO BE INSTALLED ON THE SIGN STRUCTURE IN ACCORDANCE WITH S.D.D. 12A.4.3.  
CATWALKS ARE USED ON 4-CHORD STRUCTURES CARRYING DMS SIGNS. CATWALKS SHALL BE IDENTIFIED TO THE BID ITEM "TRUSS FULL SPAN 4-CHORD (TYPE)" FOR EACH DMS SIGN STRUCTURE IN THE PLAN SET.  
UNLESS DETAILED OTHERWISE IN THE PLANS, ALL H.S. BOLTED CONNECTIONS SHALL BE MADE WITH 3/4" DIA A325 GALVANIZED BOLTS. FIELD CONNECTIONS SHALL BE INSTALLED WITH DT1 WASHERS.  
WELDED CONNECTIONS CAN BE USED IN LIEU OF BOLTED CONNECTIONS, IF A TRUSS UNIT CAN BE GALVANIZED IN ONE PIECE.  
WELD TEST AS PER AWS D1.1.  
SEE SIGN PLATE NO. A4-6, A4-7A & A4-7B OF THE SIGN PLATE MANUAL FOR INSTRUCTIONS ON CENTERING SIGNS VERTICALLY ON THE TRUSS.  
SIGNS OR BLANKS SHALL BE INSTALLED ON TRUSS AT TIME OF ERECTION. BLANKS SHALL BE 1/4 THE LENGTH OF THE CANTILEVER SPAN, 2'-0" DEEPER THAN THE E.C.L. OF CHORDS, AND SHALL BE CENTERED ON THE BRIDGE. SIGNS SHALL BE AS DESIGNATED ON THE PLANS.  
THE INFORMATION SHOWN ON THESE DRAWINGS CONCERNING TYPE AND LOCATION OF UNDERGROUND UTILITIES IS NOT GUARANTEED TO BE ACCURATE OR ALL-INCLUSIVE. THE CONTRACTOR IS RESPONSIBLE FOR MAKING HIS OWN DETERMINATION OF THE TYPE AND LOCATION OF UTILITIES AS MAY BE NECESSARY TO AVOID DAMAGE.  
CONTRACTOR SHALL SUBMIT SHOP DRAWINGS PER THE REQUIREMENTS IN THE STANDARD SPECIFICATIONS PRIOR TO FABRICATION OF THE STRUCTURE. CONTRACTOR SHALL SHOW SIGNS ON THE SHOP DRAWINGS.  
THE CONTRACTOR SHALL BE RESPONSIBLE FOR DRILLING OR EYECAVING AND MAINTAINING A STABLE AND OPEN HOLE FOR SUBSEQUENT INSTALLATION OF CONCRETE MASONRY FOR THE DRILLED SHAFTS. PARTIAL OR FULL DEPTH TEMPORARY CASING MAY BE REQUIRED TO MAINTAIN THE STABILITY OF THE EXCAVATED HOLE FOR THE SIGN SUPPORT PRIOR TO FILLING THE HOLE WITH CONCRETE. PERMANENT CASING MADE FROM STEEL OR CORRUGATED METAL PIPE MAY BE USED IN LIEU OF TEMPORARY CASING FOR PERMANENT CASING, IF USED, SHALL BE INCIDENTAL TO THE BID ITEM "DRILLING SHAFT 36-INCH".

**DESIGN DATA**  
DESIGNED ACCORDING TO THE ASHTO "LRFD SPECIFICATIONS FOR STRUCTURAL SUPPORTS FOR HIGHWAY SIGNS, LUMINAIRES, AND TRAFFIC SIGNALS", 1ST EDITION AND INTERIM SPECIFICATIONS, AND THE WISDOT BRIDGE MANUAL.  
FOUNDATION DESIGNED ACCORDING TO THE ASHTO LRFD BRIDGE DESIGN SPECIFICATIONS, 8TH EDITION.  
DEAD LOAD: W.T. OF DMS SIGN AND SUPPORTING STRUCTURE.  
WIND PRESSURE: 120 MPH (33.6 C) GUST SPEED TO SIGN AREA & EXPOSED MEMBERS.  
WIND PRESSURE: 120 MPH (33.6 C) GUST SPEED TO SIGN AREA & EXPOSED MEMBERS.  
FOUNDATION DESIGNED ACCORDING TO THE ASHTO LRFD BRIDGE DESIGN SPECIFICATIONS, 8TH EDITION.  
WIND PRESSURE: 120 MPH (33.6 C) GUST SPEED TO SIGN AREA & EXPOSED MEMBERS.  
WIND PRESSURE: 120 MPH (33.6 C) GUST SPEED TO SIGN AREA & EXPOSED MEMBERS.  
FOUNDATION DESIGNED ACCORDING TO THE ASHTO LRFD BRIDGE DESIGN SPECIFICATIONS, 8TH EDITION.

TRANSVERSE  
LOAD CASE 1: 1.00  
LOAD CASE 2: 1.00  
LOAD CASE 3: 0.75  
LOAD COMBINATIONS  
STRENGTH (1.6 DL + 1.6 LL)  
EXTREME (1.6 DC + 1.0 W + 1.0 ICE)  
SERVICE (1.0 DC + 1.0 W)  
FATIGUE (1.0 DC + 1.0 W + 1.0 TRUCK INDUCED GUST VIBRATION)  
CONCRETE MASONRY  $f_c = 3,500$  PSI  
HIGH STRENGTH BAR STEEL  
REINFORCEMENT, GRADE 60  $f_y = 60,000$  PSI  
STRUCTURAL ANGLES, PLATES,  
AND BARS - ASTM A709 GRADE 36  $f_y = 36,000$  PSI  
CHORDS & COLUMN PIPE - ASTM 500 GRADE C  $f_y = 46,000$  PSI  
HIGH STRENGTH BOLTS - A325  $f_y = 92,000$  PSI  
ANCHOR RODS - ASTM F1554 GRADE 55  $f_y = 55,000$  PSI  
HEAVY HEX NUTS FOR ANCHOR RODS - ASTM A563A  
WASHERS FOR ANCHOR RODS = ASTM F436

**FOUNDATION DATA**  
DRILLED SHAFTS ARE SUPPORTED ON DRILLED SHAFTS THAT HAVE BEEN DESIGNED FOR STRESS HEREIN. SINGLE GREATER THAN OR EQUAL TO 24" (610 MM) DIAMETER. OR A CONCRETE VALUE GREATER THAN OR EQUAL TO 750 PSF (COHESIVE SOILS) AND A UNIT WEIGHT OF 125 PCF. THE GROUND WATER TABLE IS ASSUMED TO BE AT A DEPTH OF 10'-0" BELOW THE GROUND SURFACE. ACTUAL WATER LEVEL AT THE SITE MAY VARY. THE REGION GEOTECHNICAL ENGINEER SHALL BE CONSULTED FOR THE PROPERTIES OF THE GROUND. THE CONTRACTOR SHALL CONFIRM THESE PROPERTIES PRIOR TO PLACEMENT OF THE DRILLED SHAFT CONCRETE.

**TOTAL ESTIMATED QUANTITIES**

BID ITEM NO.	BID ITEM	UNIT	S-67-420
531.2096	DRILLING SHAFT 36-INCH	LF	88
531.6120.001	FOUNDATION TWO-SHAFT TYPE II S-67-420	EA	2
532.6120.001	TRUSS FULL SPAN 4-CHORD TYPE II S-67-420	EA	1

**STRUCTURE DATA**

SIGN STR	ACTUAL SIGN AREA	ACTUAL SIGN DEPTH	DMS WEIGHT	STANDARD DESIGN TRUSS TYPE II
S-67-420	193 SF	7'-10"	3,300 LB.	

*[Signature]*  
SDR  
04/04/24



NO.	DATE	REVISION	BY

DAAR ENGINEERING, INC.  
www.daarcorp.com  
414-225-9817 / 53212  
STATE OF WISCONSIN  
DEPARTMENT OF TRANSPORTATION  
ACCEPTED  
CHIEF STRUCTURES REGION ENGINEER  
DATE

STRUCTURE S-67-420

WALKESHA COUNTY  
WISCONSIN  
I-94 W/ OVERHEAD DMS SIGN BRIDGE

DESIGN SPEC. DATE  
DESIGNED BY DATE  
DRAWN BY DATE  
CHECKED BY DATE  
PLANS DATE

GENERAL NOTES & DESIGN DATA  
SHEET 1 OF 10  
773K

DESIGN CONSULTANT  
TOM ROMENESKO, PE  
(608) 896-1370

BRIDGE OFFICE CONTACT  
AARON BONK, PE  
(608) 281-0281

DESIGN DATE: 4/7/2024 3:40:59 PM  
PLOT BY: TOM WAGAN  
PLOT SCALE: 1:1



Proposal Schedule of Items

Proposal ID: 20240409007 Project(s): 1060-10-71, 1060-47-70, 1330-47-71, 2788-03-70

Federal ID(s): N/A, N/A, N/A, N/A

SECTION: 0001 Contract Items

Alt Set ID: Alt Mbr ID:

Proposal Line Number	Item ID Description	Approximate Quantity and Units	Unit Price	Bid Amount
0002	201.0105 Clearing	9.000 STA	_____.	_____.
0004	201.0120 Clearing	50.000 ID	_____.	_____.
0006	201.0205 Grubbing	9.000 STA	_____.	_____.
0008	201.0220 Grubbing	50.000 ID	_____.	_____.
0010	203.0100 Removing Small Pipe Culverts	6.000 EACH	_____.	_____.
0012	203.0220 Removing Structure (structure) 001. C-67-25	1.000 EACH	_____.	_____.
0014	203.0220 Removing Structure (structure) 002. C-67-865	1.000 EACH	_____.	_____.
0016	203.0220 Removing Structure (structure) 003. R-67-49	1.000 EACH	_____.	_____.
0018	203.0220 Removing Structure (structure) 004. B-67-245	1.000 EACH	_____.	_____.
0020	204.0100 Removing Concrete Pavement	945.000 SY	_____.	_____.
0022	204.0109.S Removing Concrete Surface Partial Depth	101,248.000 SF	_____.	_____.
0024	204.0110 Removing Asphaltic Surface	10,165.000 SY	_____.	_____.
0026	204.0115 Removing Asphaltic Surface Butt Joints	4,783.000 SY	_____.	_____.
0028	204.0120 Removing Asphaltic Surface Milling	492,497.000 SY	_____.	_____.
0030	204.0126.S Removing Asphaltic Longitudinal Notched Wedge Joint Milling	70,112.000 LF	_____.	_____.



Proposal Schedule of Items

Proposal ID: 20240409007 Project(s): 1060-10-71, 1060-47-70, 1330-47-71, 2788-03-70

Federal ID(s): N/A, N/A, N/A, N/A

SECTION: 0001 Contract Items

Alt Set ID: Alt Mbr ID:

Proposal Line Number	Item ID Description	Approximate Quantity and Units	Unit Price	Bid Amount
0032	204.0130 Removing Curb	384.000 LF	_____.	_____.
0034	204.0150 Removing Curb & Gutter	2,992.000 LF	_____.	_____.
0036	204.0155 Removing Concrete Sidewalk	337.000 SY	_____.	_____.
0038	204.0157 Removing Concrete Barrier	970.000 LF	_____.	_____.
0040	204.0165 Removing Guardrail	12,690.000 LF	_____.	_____.
0042	204.0170 Removing Fence	2,504.000 LF	_____.	_____.
0044	204.0195 Removing Concrete Bases	56.000 EACH	_____.	_____.
0046	204.0210 Removing Manholes	1.000 EACH	_____.	_____.
0048	204.0220 Removing Inlets	7.000 EACH	_____.	_____.
0050	204.0245 Removing Storm Sewer (size) 001. 12-Inch	39.000 LF	_____.	_____.
0052	204.0245 Removing Storm Sewer (size) 002. 24-Inch	32.000 LF	_____.	_____.
0054	204.0246 Removing Ancillary Structure (structure) 001. S-67-215	1.000 EACH	_____.	_____.
0056	204.0246 Removing Ancillary Structure (structure) 002. S-67-216	1.000 EACH	_____.	_____.
0058	204.0270 Abandoning Culvert Pipes	4.000 EACH	_____.	_____.
0060	204.9060.S Removing (item description) 001. Crash Cushion	2.000 EACH	_____.	_____.





Proposal Schedule of Items

Proposal ID: 20240409007 Project(s): 1060-10-71, 1060-47-70, 1330-47-71, 2788-03-70

Federal ID(s): N/A, N/A, N/A, N/A

SECTION: 0001 Contract Items

Alt Set ID: Alt Mbr ID:

Proposal Line Number	Item ID Description	Approximate Quantity and Units	Unit Price	Bid Amount
0062	204.9060.S Removing (item description) 002. Bicycle Rack	1.000 EACH	_____.	_____.
0064	204.9060.S Removing (item description) 003. Existing Ramp Gate Assembly	1.000 EACH	_____.	_____.
0066	204.9060.S Removing (item description) 021. Traffic Signals IH 94 EB Ramps & CTH SS	1.000 EACH	_____.	_____.
0068	204.9060.S Removing (item description) 041. Removing Traffic Signals STH 318 & Silvernail Rd.	1.000 EACH	_____.	_____.
0070	204.9060.S Removing (item description) 042. Removing Loop Detector Wire & Lead-in Cable STH 318 & Silvernail Rd.	1.000 EACH	_____.	_____.
0072	204.9060.S Removing (item description) 051. Traffic Signals IH 94 EB Ramps & STH 318	1.000 EACH	_____.	_____.
0074	204.9060.S Removing (item description) 052. Loop Detector Wire and Lead In Cable IH 94 EB Ramps & STH 318	1.000 EACH	_____.	_____.
0076	204.9060.S Removing (item description) 061. Traffic Signals IH 94 WB Ramps & STH 318	1.000 EACH	_____.	_____.
0078	204.9060.S Removing (item description) 062. Loop Detector Wire and Lead In Cable IH 94 WB Ramps & STH 318	1.000 EACH	_____.	_____.
0080	204.9060.S Removing (item description) 071. Traffic Signals IH 94 EB Ramps & CTH T	1.000 EACH	_____.	_____.
0082	204.9060.S Removing (item description) 072. Loop Detector Wire and Lead In Cable IH 94 EB Ramps & CTH T	1.000 EACH	_____.	_____.
0084	204.9060.S Removing (item description) 081. Traffic Signals IH 94 WB Ramps & CTH T	1.000 EACH	_____.	_____.



Proposal Schedule of Items

Proposal ID: 20240409007 Project(s): 1060-10-71, 1060-47-70, 1330-47-71, 2788-03-70

Federal ID(s): N/A, N/A, N/A, N/A

SECTION: 0001 Contract Items

Alt Set ID: Alt Mbr ID:

Proposal Line Number	Item ID Description	Approximate Quantity and Units	Unit Price	Bid Amount
0086	204.9060.S Removing (item description) 082. Loop Detector Wire and Lead In Cable IH 94 WB Ramps & CTH T	1.000 EACH	_____.	_____.
0088	204.9060.S Removing (item description) 401. Lighting Units	5.000 EACH	_____.	_____.
0090	204.9060.S Removing (item description) 402. Luminaires	12.000 EACH	_____.	_____.
0092	204.9090.S Removing (item description) 001. Cable Barrier	2,348.000 LF	_____.	_____.
0094	205.0100 Excavation Common	2,960.000 CY	_____.	_____.
0096	206.1001 Excavation for Structures Bridges (structure) 001. B-67-245	1.000 EACH	_____.	_____.
0098	206.2001 Excavation for Structures Culverts (structure) 001. C-67-25	1.000 EACH	_____.	_____.
0100	208.0100 Borrow	2,469.000 CY	_____.	_____.
0102	209.1100 Backfill Granular Grade 1	656.000 CY	_____.	_____.
0104	210.1500 Backfill Structure Type A	464.000 TON	_____.	_____.
0106	210.2500 Backfill Structure Type B	38.000 TON	_____.	_____.
0108	211.0101 Prepare Foundation for Asphaltic Paving (project) 001. 1060-47-70	0.880 EACH	_____.	_____.
0110	211.0101 Prepare Foundation for Asphaltic Paving (project) 002. 1330-47-71	0.010 EACH	_____.	_____.
0112	211.0101 Prepare Foundation for Asphaltic Paving (project) 003. 2788-03-70	0.020 EACH	_____.	_____.



Proposal Schedule of Items

Proposal ID: 20240409007 Project(s): 1060-10-71, 1060-47-70, 1330-47-71, 2788-03-70

Federal ID(s): N/A, N/A, N/A, N/A

SECTION: 0001 Contract Items

Alt Set ID: Alt Mbr ID:

Proposal Line Number	Item ID Description	Approximate Quantity and Units	Unit Price	Bid Amount
0114	211.0101 Prepare Foundation for Asphaltic Paving (project) 004. 1060-10-71	0.090 EACH	_____.	_____.
0116	213.0100 Finishing Roadway (project) 001. 1060-47-70	1.000 EACH	_____.	_____.
0118	213.0100 Finishing Roadway (project) 002. 1330-47-71	1.000 EACH	_____.	_____.
0120	213.0100 Finishing Roadway (project) 003. 2788-03-70	1.000 EACH	_____.	_____.
0122	213.0100 Finishing Roadway (project) 004. 1060-10-71	1.000 EACH	_____.	_____.
0124	305.0110 Base Aggregate Dense 3/4-Inch	2,683.000 TON	_____.	_____.
0126	305.0120 Base Aggregate Dense 1 1/4-Inch	1,631.000 TON	_____.	_____.
0128	390.0100 Removing Pavement for Base Patching	4,162.000 CY	_____.	_____.
0130	390.0405 Base Patching Concrete SHES	4,162.000 CY	_____.	_____.
0132	415.0070 Concrete Pavement 7-Inch	100.000 SY	_____.	_____.
0134	415.0080 Concrete Pavement 8-Inch	107.000 SY	_____.	_____.
0136	415.0090 Concrete Pavement 9-Inch	371.000 SY	_____.	_____.
0138	415.0410 Concrete Pavement Approach Slab	507.000 SY	_____.	_____.
0140	416.0610 Drilled Tie Bars	669.000 EACH	_____.	_____.
0142	416.0620 Drilled Dowel Bars	21,530.000 EACH	_____.	_____.



Proposal Schedule of Items

Proposal ID: 20240409007 Project(s): 1060-10-71, 1060-47-70, 1330-47-71, 2788-03-70

Federal ID(s): N/A, N/A, N/A, N/A

SECTION: 0001 Contract Items

Alt Set ID: Alt Mbr ID:

Proposal Line Number	Item ID Description	Approximate Quantity and Units	Unit Price	Bid Amount
0144	416.1710 Concrete Pavement Repair	92.000 SY	_____.	_____.
0146	416.1715 Concrete Pavement Repair SHES	824.000 SY	_____.	_____.
0148	416.1720 Concrete Pavement Replacement	430.000 SY	_____.	_____.
0150	416.1725 Concrete Pavement Replacement SHES	589.000 SY	_____.	_____.
0152	455.0605 Tack Coat	45,917.000 GAL	_____.	_____.
0154	460.0105.S HMA Percent Within Limits (PWL) Test Strip Volumetrics	1.000 EACH	_____.	_____.
0156	460.0110.S HMA Percent Within Limits (PWL) Test Strip Density	2.000 EACH	_____.	_____.
0158	460.0115.S HMA Pavement Test Strip Volumetrics	1.000 EACH	_____.	_____.
0160	460.0120.S HMA Pavement Test Strip Density	3.000 EACH	_____.	_____.
0162	460.2000 Incentive Density HMA Pavement	35,576.000 DOL	1.00000	35,576.00
0164	460.2005 Incentive Density PWL HMA Pavement	34,580.000 DOL	1.00000	34,580.00
0166	460.2007 Incentive Density HMA Pavement Longitudinal Joints	17,800.000 DOL	1.00000	17,800.00
0168	460.2010 Incentive Air Voids HMA Pavement	34,580.000 DOL	1.00000	34,580.00
0170	460.6224 HMA Pavement 4 MT 58-28 S	6,613.000 TON	_____.	_____.
0172	460.7423 HMA Pavement 3 HT 58-28 H	34,577.000 TON	_____.	_____.



Proposal Schedule of Items

Proposal ID: 20240409007 Project(s): 1060-10-71, 1060-47-70, 1330-47-71, 2788-03-70

Federal ID(s): N/A, N/A, N/A, N/A

SECTION: 0001 Contract Items

Alt Set ID: Alt Mbr ID:

Proposal Line Number	Item ID Description	Approximate Quantity and Units	Unit Price	Bid Amount
0174	460.8624 HMA Pavement 4 SMA 58-28 V	49,422.000 TON	_____.	_____.
0176	460.9000.S Material Transfer Vehicle 001. 1060-47-70	1.000 EACH	_____.	_____.
0178	465.0105 Asphaltic Surface	709.000 TON	_____.	_____.
0180	465.0115 Asphaltic Surface Detours	585.000 TON	_____.	_____.
0182	465.0125 Asphaltic Surface Temporary	2,208.000 TON	_____.	_____.
0184	465.0305 Asphaltic Surface Safety Islands	109.000 TON	_____.	_____.
0186	465.0310 Asphaltic Curb	160.000 LF	_____.	_____.
0188	465.0315 Asphaltic Flumes	11.000 SY	_____.	_____.
0190	465.0510 Asphaltic Rumble Strips, Shoulder Divided Roadway	124,424.000 LF	_____.	_____.
0192	502.0100 Concrete Masonry Bridges	201.000 CY	_____.	_____.
0194	502.3200 Protective Surface Treatment	156.000 SY	_____.	_____.
0196	502.3205 Pigmented Surface Sealer Reseal	473.000 SY	_____.	_____.
0198	502.4204 Adhesive Anchors No. 4 Bar	298.000 EACH	_____.	_____.
0200	504.0100 Concrete Masonry Culverts	6.100 CY	_____.	_____.
0202	505.0600 Bar Steel Reinforcement HS Coated Structures	19,905.000 LB	_____.	_____.



Proposal Schedule of Items

Proposal ID: 20240409007 Project(s): 1060-10-71, 1060-47-70, 1330-47-71, 2788-03-70

Federal ID(s): N/A, N/A, N/A, N/A

SECTION: 0001 Contract Items

Alt Set ID: Alt Mbr ID:

Proposal Line Number	Item ID Description	Approximate Quantity and Units	Unit Price	Bid Amount
0204	505.0904 Bar Couplers No. 4	4.000 EACH	_____.	_____.
0206	505.0905 Bar Couplers No. 5	36.000 EACH	_____.	_____.
0208	505.0906 Bar Couplers No. 6	10.000 EACH	_____.	_____.
0210	506.2610 Bearing Pads Elastomeric Laminated	8.000 EACH	_____.	_____.
0212	506.7050.S Removing Bearings (structure) 001. B-67-245	8.000 EACH	_____.	_____.
0214	509.0301 Preparation Decks Type 1	9.000 SY	_____.	_____.
0216	509.0302 Preparation Decks Type 2	2.500 SY	_____.	_____.
0218	509.0310.S Sawing Pavement Deck Preparation Areas	111.000 LF	_____.	_____.
0220	509.1500 Concrete Surface Repair	118.000 SF	_____.	_____.
0222	509.2100.S Concrete Masonry Deck Repair	1.100 CY	_____.	_____.
0224	509.9050.S Cleaning Parapets	1,201.000 LF	_____.	_____.
0226	511.1200 Temporary Shoring (structure) 001. C-67-25	50.000 SF	_____.	_____.
0228	511.1200 Temporary Shoring (structure) 002. R-67-159	1,000.000 SF	_____.	_____.
0230	511.1200 Temporary Shoring (structure) 003. B-67-245	800.000 SF	_____.	_____.
0232	516.0500 Rubberized Membrane Waterproofing	88.000 SY	_____.	_____.



Proposal Schedule of Items

Proposal ID: 20240409007 Project(s): 1060-10-71, 1060-47-70, 1330-47-71, 2788-03-70

Federal ID(s): N/A, N/A, N/A, N/A

SECTION: 0001 Contract Items

Alt Set ID: Alt Mbr ID:

Proposal Line Number	Item ID Description	Approximate Quantity and Units	Unit Price	Bid Amount
0234	520.8000 Concrete Collars for Pipe	11.000 EACH	_____.	_____.
0236	520.9700.S Culvert Pipe Liners (size) 001. 18-Inch	236.000 LF	_____.	_____.
0238	520.9750.S Cleaning Culvert Pipes for Liner Verification	3.000 EACH	_____.	_____.
0240	521.1012 Apron Endwalls for Culvert Pipe Steel 12-Inch	4.000 EACH	_____.	_____.
0242	521.1018 Apron Endwalls for Culvert Pipe Steel 18-Inch	1.000 EACH	_____.	_____.
0244	521.3118 Culvert Pipe Corrugated Steel 18-Inch	40.000 LF	_____.	_____.
0246	522.0412 Culvert Pipe Reinforced Concrete Class IV 12-Inch	96.000 LF	_____.	_____.
0248	522.0418 Culvert Pipe Reinforced Concrete Class IV 18-Inch	371.000 LF	_____.	_____.
0250	522.0424 Culvert Pipe Reinforced Concrete Class IV 24-Inch	8.000 LF	_____.	_____.
0252	522.1012 Apron Endwalls for Culvert Pipe Reinforced Concrete 12-Inch	2.000 EACH	_____.	_____.
0254	522.1018 Apron Endwalls for Culvert Pipe Reinforced Concrete 18-Inch	3.000 EACH	_____.	_____.
0256	522.2419 Culvert Pipe Reinforced Concrete Horizontal Elliptical Class HE-IV 19x30-Inch	75.000 LF	_____.	_____.
0258	522.2619 Apron Endwalls for Culvert Pipe Reinforced Concrete Horizontal Elliptical 19x30-Inch	2.000 EACH	_____.	_____.



Proposal Schedule of Items

Proposal ID: 20240409007 Project(s): 1060-10-71, 1060-47-70, 1330-47-71, 2788-03-70

Federal ID(s): N/A, N/A, N/A, N/A

SECTION: 0001 Contract Items

Alt Set ID: Alt Mbr ID:

Proposal Line Number	Item ID Description	Approximate Quantity and Units	Unit Price	Bid Amount
0260	524.0624 Apron Endwalls for Culvert Pipe Salvaged 24-Inch	1.000 EACH	_____.	_____.
0262	530.0112 Culvert Pipe Corrugated Polyethylene 12-Inch	131.000 LF	_____.	_____.
0264	531.1100 Concrete Masonry Ancillary Structures Type NS	36.000 CY	_____.	_____.
0266	531.1140 Steel Reinforcement HS Ancillary Structures Type NS	4,968.000 LB	_____.	_____.
0268	531.2020 Drilling Shaft 20-Inch	7.000 LF	_____.	_____.
0270	531.2024 Drilling Shaft 24-Inch	304.000 LF	_____.	_____.
0272	531.2036 Drilling Shaft 36-Inch	118.000 LF	_____.	_____.
0274	531.4030 Foundation Camera Pole 30-FT	1.000 EACH	_____.	_____.
0276	531.4050 Foundation Camera Pole 50-FT	3.000 EACH	_____.	_____.
0278	531.6120 Foundation Two-Shaft Type FF-II (structure) 001. S-67-420	1.000 EACH	_____.	_____.
0280	532.6120 Truss Full Span 4-Chord Type II (structure) 001. S-67-420	2.000 EACH	_____.	_____.
0282	601.0115 Concrete Curb Type G	218.000 LF	_____.	_____.
0284	601.0411 Concrete Curb & Gutter 30-Inch Type D	768.000 LF	_____.	_____.
0286	601.0413 Concrete Curb & Gutter 6-Inch Sloped 30-Inch Type G	2,254.000 LF	_____.	_____.





Proposal Schedule of Items

Proposal ID: 20240409007 Project(s): 1060-10-71, 1060-47-70, 1330-47-71, 2788-03-70

Federal ID(s): N/A, N/A, N/A, N/A

SECTION: 0001 Contract Items

Alt Set ID: Alt Mbr ID:

Proposal Line Number	Item ID Description	Approximate Quantity and Units	Unit Price	Bid Amount
0288	601.0588 Concrete Curb & Gutter 4-Inch Sloped 36-Inch Type TBT	168.000 LF	_____.	_____.
0290	601.0590 Concrete Curb & Gutter 4-Inch Sloped 36-Inch Type TBTT	334.000 LF	_____.	_____.
0292	601.0600 Concrete Curb Pedestrian	23.000 LF	_____.	_____.
0294	602.0405 Concrete Sidewalk 4-Inch	1,272.000 SF	_____.	_____.
0296	602.0410 Concrete Sidewalk 5-Inch	3,736.000 SF	_____.	_____.
0298	602.0505 Curb Ramp Detectable Warning Field Yellow	140.000 SF	_____.	_____.
0300	602.0605 Curb Ramp Detectable Warning Field Radial Yellow	95.000 SF	_____.	_____.
0302	602.3010 Concrete Surface Drains	3.000 CY	_____.	_____.
0304	603.0105 Concrete Barrier Single-Faced 32-Inch	40.000 LF	_____.	_____.
0306	603.1132 Concrete Barrier Type S32	10.000 LF	_____.	_____.
0308	603.1142 Concrete Barrier Type S42	10.000 LF	_____.	_____.
0310	603.3211 Concrete Barrier Transition Type F32SF to S32	1.000 EACH	_____.	_____.
0312	603.3475 Concrete Barrier Transition Type F51DF to S42	1.000 EACH	_____.	_____.
0314	603.8000 Concrete Barrier Temporary Precast Delivered	6,390.000 LF	_____.	_____.



Proposal Schedule of Items

Proposal ID: 20240409007 Project(s): 1060-10-71, 1060-47-70, 1330-47-71, 2788-03-70

Federal ID(s): N/A, N/A, N/A, N/A

SECTION: 0001 Contract Items

Alt Set ID: Alt Mbr ID:

Proposal Line Number	Item ID Description	Approximate Quantity and Units	Unit Price	Bid Amount
0316	603.8125 Concrete Barrier Temporary Precast Installed	6,493.000 LF	_____.	_____.
0318	604.0400 Slope Paving Concrete	11.000 SY	_____.	_____.
0320	604.0500 Slope Paving Crushed Aggregate	672.000 SY	_____.	_____.
0322	606.0100 Riprap Light	4.000 CY	_____.	_____.
0324	606.0200 Riprap Medium	57.000 CY	_____.	_____.
0326	606.0300 Riprap Heavy	28.000 CY	_____.	_____.
0328	608.0312 Storm Sewer Pipe Reinforced Concrete Class III 12-Inch	46.000 LF	_____.	_____.
0330	608.0324 Storm Sewer Pipe Reinforced Concrete Class III 24-Inch	32.000 LF	_____.	_____.
0332	611.0430 Reconstructing Inlets	16.000 EACH	_____.	_____.
0334	611.0530 Manhole Covers Type J	6.000 EACH	_____.	_____.
0336	611.0624 Inlet Covers Type H	4.000 EACH	_____.	_____.
0338	611.0654 Inlet Covers Type V	25.000 EACH	_____.	_____.
0340	611.2005 Manholes 5-FT Diameter	1.000 EACH	_____.	_____.
0342	611.3004 Inlets 4-FT Diameter	1.000 EACH	_____.	_____.
0344	611.3225 Inlets 2x2.5-FT	6.000 EACH	_____.	_____.



Proposal Schedule of Items

Proposal ID: 20240409007 Project(s): 1060-10-71, 1060-47-70, 1330-47-71, 2788-03-70

Federal ID(s): N/A, N/A, N/A, N/A

SECTION: 0001 Contract Items

Alt Set ID: Alt Mbr ID:

Proposal Line Number	Item ID Description	Approximate Quantity and Units	Unit Price	Bid Amount
0346	611.3230 Inlets 2x3-FT	2.000 EACH	_____.	_____.
0348	611.8110 Adjusting Manhole Covers	6.000 EACH	_____.	_____.
0350	611.8115 Adjusting Inlet Covers	9.000 EACH	_____.	_____.
0352	611.9710 Salvaged Inlet Covers	3.000 EACH	_____.	_____.
0354	612.0106 Pipe Underdrain 6-Inch	70.000 LF	_____.	_____.
0356	612.0406 Pipe Underdrain Wrapped 6-Inch	235.000 LF	_____.	_____.
0358	612.0700 Drain Tile Exploration	70.000 LF	_____.	_____.
0360	612.0806 Apron Endwalls for Underdrain Reinforced Concrete 6-Inch	2.000 EACH	_____.	_____.
0362	613.1100.S Cable Barrier Type 1	2,183.000 LF	_____.	_____.
0364	613.1200.S Cable Barrier End Terminal Type 1	3.000 EACH	_____.	_____.
0366	614.0010 Barrier System Grading Shaping Finishing	15.000 EACH	_____.	_____.
0368	614.0150 Anchor Assemblies for Steel Plate Beam Guard	2.000 EACH	_____.	_____.
0370	614.0230 Steel Thrie Beam	13.000 LF	_____.	_____.
0372	614.0396 Guardrail Mow Strip Asphalt	190.000 SY	_____.	_____.
0374	614.0397 Guardrail Mow Strip Emulsified Asphalt	5,499.000 SY	_____.	_____.



Proposal Schedule of Items

Proposal ID: 20240409007 Project(s): 1060-10-71, 1060-47-70, 1330-47-71, 2788-03-70

Federal ID(s): N/A, N/A, N/A, N/A

SECTION: 0001 Contract Items

Alt Set ID: Alt Mbr ID:

Proposal Line Number	Item ID Description	Approximate Quantity and Units	Unit Price	Bid Amount
0376	614.0400 Adjusting Steel Plate Beam Guard	378.000 LF	_____.	_____.
0378	614.0800 Crash Cushions Permanent	1.000 EACH	_____.	_____.
0380	614.0805 Crash Cushions Permanent Low Maintenance	1.000 EACH	_____.	_____.
0382	614.0905 Crash Cushions Temporary	15.000 EACH	_____.	_____.
0384	614.0920 Salvaged Rail	478.000 LF	_____.	_____.
0386	614.0950 Replacing Guardrail Posts and Blocks	75.000 EACH	_____.	_____.
0388	614.0951 Replacing Guardrail Rail and Hardware	49.000 LF	_____.	_____.
0390	614.0952 Replacing Guardrail Reflectors	2.000 EACH	_____.	_____.
0392	614.2300 MGS Guardrail 3	11,151.000 LF	_____.	_____.
0394	614.2330 MGS Guardrail 3 K	275.000 LF	_____.	_____.
0396	614.2350 MGS Guardrail Short Radius	33.000 LF	_____.	_____.
0398	614.2500 MGS Thrie Beam Transition	674.000 LF	_____.	_____.
0400	614.2610 MGS Guardrail Terminal EAT	26.000 EACH	_____.	_____.
0402	614.2620 MGS Guardrail Terminal Type 2	15.000 EACH	_____.	_____.
0404	616.0100 Fence Woven Wire (height) 001. 4-FT	2,262.000 LF	_____.	_____.
0406	616.0206 Fence Chain Link 6-FT	242.000 LF	_____.	_____.



Proposal Schedule of Items

Proposal ID: 20240409007 Project(s): 1060-10-71, 1060-47-70, 1330-47-71, 2788-03-70

Federal ID(s): N/A, N/A, N/A, N/A

SECTION: 0001 Contract Items

Alt Set ID: Alt Mbr ID:

Proposal Line Number	Item ID Description	Approximate Quantity and Units	Unit Price	Bid Amount
0408	616.0700.S Fence Safety	2,470.000 LF	_____.	_____.
0410	618.0100 Maintenance and Repair of Haul Roads (project) 001. 1060-10-71	1.000 EACH	_____.	_____.
0412	619.1000 Mobilization	1.000 EACH	_____.	_____.
0414	620.0300 Concrete Median Sloped Nose	67.000 SF	_____.	_____.
0416	624.0100 Water	849.000 MGAL	_____.	_____.
0418	625.0100 Topsoil	2,989.000 SY	_____.	_____.
0420	625.0500 Salvaged Topsoil	11,571.000 SY	_____.	_____.
0422	627.0200 Mulching	100.000 SY	_____.	_____.
0424	628.1504 Silt Fence	10,359.000 LF	_____.	_____.
0426	628.1520 Silt Fence Maintenance	10,359.000 LF	_____.	_____.
0428	628.1905 Mobilizations Erosion Control	15.000 EACH	_____.	_____.
0430	628.1910 Mobilizations Emergency Erosion Control	15.000 EACH	_____.	_____.
0432	628.2002 Erosion Mat Class I Type A	492.000 SY	_____.	_____.
0434	628.2004 Erosion Mat Class I Type B	10,875.000 SY	_____.	_____.
0436	628.2006 Erosion Mat Urban Class I Type A	665.000 SY	_____.	_____.
0438	628.7005 Inlet Protection Type A	14.000 EACH	_____.	_____.



Proposal Schedule of Items

Proposal ID: 20240409007 Project(s): 1060-10-71, 1060-47-70, 1330-47-71, 2788-03-70

Federal ID(s): N/A, N/A, N/A, N/A

SECTION: 0001 Contract Items

Alt Set ID: Alt Mbr ID:

Proposal Line Number	Item ID Description	Approximate Quantity and Units	Unit Price	Bid Amount
0440	628.7010 Inlet Protection Type B	119.000 EACH	_____.	_____.
0442	628.7015 Inlet Protection Type C	66.000 EACH	_____.	_____.
0444	628.7504 Temporary Ditch Checks	80.000 LF	_____.	_____.
0446	628.7555 Culvert Pipe Checks	11.000 EACH	_____.	_____.
0448	628.7560 Tracking Pads	2.000 EACH	_____.	_____.
0450	628.7570 Rock Bags	10.000 EACH	_____.	_____.
0452	629.0205 Fertilizer Type A	4.000 CWT	_____.	_____.
0454	629.0210 Fertilizer Type B	102.500 CWT	_____.	_____.
0456	630.0120 Seeding Mixture No. 20	14.000 LB	_____.	_____.
0458	630.0130 Seeding Mixture No. 30	50.000 LB	_____.	_____.
0460	630.0140 Seeding Mixture No. 40	10.000 LB	_____.	_____.
0462	630.0200 Seeding Temporary	69.000 LB	_____.	_____.
0464	630.0500 Seed Water	286.000 MGAL	_____.	_____.
0466	631.0300 Sod Water	74.000 MGAL	_____.	_____.
0468	631.1000 Sod Lawn	2,708.000 SY	_____.	_____.
0470	631.1100 Sod Erosion Control	5.000 SY	_____.	_____.



Proposal Schedule of Items

Proposal ID: 20240409007 Project(s): 1060-10-71, 1060-47-70, 1330-47-71, 2788-03-70

Federal ID(s): N/A, N/A, N/A, N/A

SECTION: 0001 Contract Items

Alt Set ID: Alt Mbr ID:

Proposal Line Number	Item ID Description	Approximate Quantity and Units	Unit Price	Bid Amount
0472	633.5200 Markers Culvert End	65.000 EACH	_____.	_____.
0474	634.0618 Posts Wood 4x6-Inch X 18-FT	288.000 EACH	_____.	_____.
0476	634.0622 Posts Wood 4x6-Inch X 22-FT	7.000 EACH	_____.	_____.
0478	634.0814 Posts Tubular Steel 2x2-Inch X 14-FT	25.000 EACH	_____.	_____.
0480	634.0816 Posts Tubular Steel 2x2-Inch X 16-FT	2.000 EACH	_____.	_____.
0482	634.0885 Posts Tubular Steel 2x2-Inch X 8.5-FT	12.000 EACH	_____.	_____.
0484	635.0200 Sign Supports Structural Steel HS	20,900.000 LB	_____.	_____.
0486	637.1220 Signs Type I Reflective SH	3,074.000 SF	_____.	_____.
0488	637.1230 Signs Type I Reflective F	90.000 SF	_____.	_____.
0490	637.2210 Signs Type II Reflective H	2,718.705 SF	_____.	_____.
0492	637.2215 Signs Type II Reflective H Folding	585.380 SF	_____.	_____.
0494	637.2230 Signs Type II Reflective F	228.000 SF	_____.	_____.
0496	638.2101 Moving Signs Type I	2.000 EACH	_____.	_____.
0498	638.2102 Moving Signs Type II	18.000 EACH	_____.	_____.
0500	638.2601 Removing Signs Type I	25.000 EACH	_____.	_____.
0502	638.2602 Removing Signs Type II	374.000 EACH	_____.	_____.



Proposal Schedule of Items

Proposal ID: 20240409007 Project(s): 1060-10-71, 1060-47-70, 1330-47-71, 2788-03-70

Federal ID(s): N/A, N/A, N/A, N/A

SECTION: 0001 Contract Items

Alt Set ID: Alt Mbr ID:

Proposal Line Number	Item ID Description	Approximate Quantity and Units	Unit Price	Bid Amount
0504	638.3000 Removing Small Sign Supports	272.000 EACH	_____.	_____.
0506	638.3100 Removing Structural Steel Sign Supports	36.000 EACH	_____.	_____.
0508	643.0300 Traffic Control Drums	141,812.000 DAY	_____.	_____.
0510	643.0420 Traffic Control Barricades Type III	9,817.000 DAY	_____.	_____.
0512	643.0500 Traffic Control Flexible Tubular Marker Posts	35.000 EACH	_____.	_____.
0514	643.0600 Traffic Control Flexible Tubular Marker Bases	35.000 EACH	_____.	_____.
0516	643.0705 Traffic Control Warning Lights Type A	18,199.000 DAY	_____.	_____.
0518	643.0715 Traffic Control Warning Lights Type C	15,870.000 DAY	_____.	_____.
0520	643.0800 Traffic Control Arrow Boards	1,707.000 DAY	_____.	_____.
0522	643.0900 Traffic Control Signs	39,448.000 DAY	_____.	_____.
0524	643.0910 Traffic Control Covering Signs Type I	4.000 EACH	_____.	_____.
0526	643.0920 Traffic Control Covering Signs Type II	19.000 EACH	_____.	_____.
0528	643.1000 Traffic Control Signs Fixed Message	378.000 SF	_____.	_____.
0530	643.1050 Traffic Control Signs PCMS	675.000 DAY	_____.	_____.
0532	643.1070 Traffic Control Cones 42-Inch	8,544.000 DAY	_____.	_____.
0534	643.1500 Traffic Control Speed Radar Trailer	260.000 DAY	_____.	_____.





Proposal Schedule of Items

Proposal ID: 20240409007 Project(s): 1060-10-71, 1060-47-70, 1330-47-71, 2788-03-70

Federal ID(s): N/A, N/A, N/A, N/A

SECTION: 0001 Contract Items

Alt Set ID: Alt Mbr ID:

Proposal Line Number	Item ID Description	Approximate Quantity and Units	Unit Price	Bid Amount
0536	643.3105 Temporary Marking Line Paint 4-Inch	1,246.000 LF	_____.	_____.
0538	643.3150 Temporary Marking Line Removable Tape 4-Inch	27,942.000 LF	_____.	_____.
0540	643.3165 Temporary Marking Line Paint 6-Inch	304,294.000 LF	_____.	_____.
0542	643.3180 Temporary Marking Line Removable Tape 6-Inch	2,340.000 LF	_____.	_____.
0544	643.3250 Temporary Marking Line Removable Tape 8-Inch	505.000 LF	_____.	_____.
0546	643.3265 Temporary Marking Line Paint 10-Inch	33,703.000 LF	_____.	_____.
0548	643.3760 Temporary Marking Raised Pavement Marker Type I	24.000 EACH	_____.	_____.
0550	643.3770 Temporary Marking Raised Pavement Marker Type II	282.000 EACH	_____.	_____.
0552	643.3850 Temporary Marking Stop Line Removable Tape 18-Inch	150.000 LF	_____.	_____.
0554	643.4100 Traffic Control Interim Lane Closure	291.000 EACH	_____.	_____.
0556	643.5000 Traffic Control	1.000 EACH	_____.	_____.
0558	644.1410 Temporary Pedestrian Surface Asphalt	192.000 SF	_____.	_____.
0560	644.1430 Temporary Pedestrian Surface Plate	208.000 SF	_____.	_____.
0562	644.1601 Temporary Pedestrian Curb Ramp	118.000 DAY	_____.	_____.



Proposal Schedule of Items

Proposal ID: 20240409007 Project(s): 1060-10-71, 1060-47-70, 1330-47-71, 2788-03-70

Federal ID(s): N/A, N/A, N/A, N/A

SECTION: 0001 Contract Items

Alt Set ID: Alt Mbr ID:

Proposal Line Number	Item ID Description	Approximate Quantity and Units	Unit Price	Bid Amount
0564	644.1605 Temporary Pedestrian Detectable Warning Field	70.000 SF	_____.	_____.
0566	644.1810 Temporary Pedestrian Barricade	2,578.000 LF	_____.	_____.
0568	645.0120 Geotextile Type HR	30.000 SY	_____.	_____.
0570	645.0130 Geotextile Type R	19.000 SY	_____.	_____.
0572	646.1020 Marking Line Epoxy 4-Inch	26,497.000 LF	_____.	_____.
0574	646.2020 Marking Line Epoxy 6-Inch	20,283.000 LF	_____.	_____.
0576	646.2025 Marking Line Grooved Black Epoxy 6-Inch	28,347.000 LF	_____.	_____.
0578	646.2040 Marking Line Grooved Wet Ref Epoxy 6-Inch	153,923.000 LF	_____.	_____.
0580	646.2050 Marking Line Grooved Permanent Tape 6-Inch	28,347.000 LF	_____.	_____.
0582	646.3020 Marking Line Epoxy 8-Inch	3,613.000 LF	_____.	_____.
0584	646.4020 Marking Line Epoxy 10-Inch	3,203.000 LF	_____.	_____.
0586	646.4025 Marking Line Grooved Black Epoxy 10-Inch	194.000 LF	_____.	_____.
0588	646.4050 Marking Line Grooved Permanent Tape 10-Inch	16,851.000 LF	_____.	_____.
0590	646.5020 Marking Arrow Epoxy	106.000 EACH	_____.	_____.
0592	646.5120 Marking Word Epoxy	36.000 EACH	_____.	_____.



Proposal Schedule of Items

Proposal ID: 20240409007 Project(s): 1060-10-71, 1060-47-70, 1330-47-71, 2788-03-70

Federal ID(s): N/A, N/A, N/A, N/A

SECTION: 0001 Contract Items

Alt Set ID: Alt Mbr ID:

Proposal Line Number	Item ID Description	Approximate Quantity and Units	Unit Price	Bid Amount
0594	646.5205 Marking Symbol Paint	12.000 EACH	_____.	_____.
0596	646.5220 Marking Symbol Epoxy	13.000 EACH	_____.	_____.
0598	646.5520 Marking Outfall Epoxy	5.000 EACH	_____.	_____.
0600	646.6120 Marking Stop Line Epoxy 18-Inch	984.000 LF	_____.	_____.
0602	646.6220 Marking Yield Line Epoxy 18-Inch	82.000 EACH	_____.	_____.
0604	646.7120 Marking Diagonal Epoxy 12-Inch	2,016.000 LF	_____.	_____.
0606	646.7220 Marking Chevron Epoxy 24-Inch	1,726.000 LF	_____.	_____.
0608	646.7420 Marking Crosswalk Epoxy Transverse Line 6-Inch	409.000 LF	_____.	_____.
0610	646.8020 Marking Corrugated Median Epoxy	72.000 SF	_____.	_____.
0612	646.8120 Marking Curb Epoxy	1,010.000 LF	_____.	_____.
0614	646.8220 Marking Island Nose Epoxy	9.000 EACH	_____.	_____.
0616	646.9000 Marking Removal Line 4-Inch	599.000 LF	_____.	_____.
0618	646.9010 Marking Removal Line Water Blasting 4-Inch	1,976.000 LF	_____.	_____.
0620	646.9055 Marking Removal Line Grooved Contrast Permanent Tape 4-Inch	4,600.000 LF	_____.	_____.
0622	646.9100 Marking Removal Line 8-Inch	280.000 LF	_____.	_____.



Proposal Schedule of Items

Proposal ID: 20240409007 Project(s): 1060-10-71, 1060-47-70, 1330-47-71, 2788-03-70

Federal ID(s): N/A, N/A, N/A, N/A

SECTION: 0001 Contract Items

Alt Set ID: Alt Mbr ID:

Proposal Line Number	Item ID Description	Approximate Quantity and Units	Unit Price	Bid Amount
0624	646.9110 Marking Removal Line Water Blasting 8-Inch	832.000 LF	_____.	_____.
0626	646.9200 Marking Removal Line Wide	55.000 LF	_____.	_____.
0628	646.9210 Marking Removal Line Water Blasting Wide	70.000 LF	_____.	_____.
0630	646.9300 Marking Removal Special Marking	12.000 EACH	_____.	_____.
0632	646.9310 Marking Removal Special Marking Water Blasting	11.000 EACH	_____.	_____.
0634	652.0125 Conduit Rigid Metallic 2-Inch	85.000 LF	_____.	_____.
0636	652.0225 Conduit Rigid Nonmetallic Schedule 40 2-Inch	5,402.000 LF	_____.	_____.
0638	652.0235 Conduit Rigid Nonmetallic Schedule 40 3-Inch	2,048.000 LF	_____.	_____.
0640	652.0240 Conduit Rigid Nonmetallic Schedule 40 4-Inch	24.000 LF	_____.	_____.
0642	652.0605 Conduit Special 2-Inch	800.000 LF	_____.	_____.
0644	652.0615 Conduit Special 3-Inch	3,951.000 LF	_____.	_____.
0646	652.0700.S Install Conduit into Existing Item	12.000 EACH	_____.	_____.
0648	652.0800 Conduit Loop Detector	4,295.000 LF	_____.	_____.
0650	653.0135 Pull Boxes Steel 24x36-Inch	22.000 EACH	_____.	_____.
0652	653.0140 Pull Boxes Steel 24x42-Inch	64.000 EACH	_____.	_____.



Proposal Schedule of Items

Proposal ID: 20240409007 Project(s): 1060-10-71, 1060-47-70, 1330-47-71, 2788-03-70

Federal ID(s): N/A, N/A, N/A, N/A

SECTION: 0001 Contract Items

Alt Set ID: Alt Mbr ID:

Proposal Line Number	Item ID Description	Approximate Quantity and Units	Unit Price	Bid Amount
0654	653.0905 Removing Pull Boxes	96.000 EACH	_____.	_____.
0656	654.0101 Concrete Bases Type 1	13.000 EACH	_____.	_____.
0658	654.0102 Concrete Bases Type 2	5.000 EACH	_____.	_____.
0660	654.0105 Concrete Bases Type 5	2.000 EACH	_____.	_____.
0662	654.0110 Concrete Bases Type 10	3.000 EACH	_____.	_____.
0664	654.0113 Concrete Bases Type 13	5.000 EACH	_____.	_____.
0666	654.0120 Concrete Bases Type 10-Special	10.000 EACH	_____.	_____.
0668	654.0217 Concrete Control Cabinet Bases Type 9 Special	3.000 EACH	_____.	_____.
0670	654.1239 Concrete Control Cabinet Bases ITS	1.000 EACH	_____.	_____.
0672	655.0210 Cable Traffic Signal 3-14 AWG	4,259.000 LF	_____.	_____.
0674	655.0230 Cable Traffic Signal 5-14 AWG	2,713.000 LF	_____.	_____.
0676	655.0240 Cable Traffic Signal 7-14 AWG	4,374.000 LF	_____.	_____.
0678	655.0260 Cable Traffic Signal 12-14 AWG	3,535.000 LF	_____.	_____.
0680	655.0270 Cable Traffic Signal 15-14 AWG	158.000 LF	_____.	_____.
0682	655.0320 Cable Type UF 2-10 AWG Grounded	4,018.000 LF	_____.	_____.
0684	655.0510 Electrical Wire Traffic Signals 12 AWG	432.000 LF	_____.	_____.



Proposal Schedule of Items

Proposal ID: 20240409007 Project(s): 1060-10-71, 1060-47-70, 1330-47-71, 2788-03-70

Federal ID(s): N/A, N/A, N/A, N/A

SECTION: 0001 Contract Items

Alt Set ID: Alt Mbr ID:

Proposal Line Number	Item ID Description	Approximate Quantity and Units	Unit Price	Bid Amount
0686	655.0515 Electrical Wire Traffic Signals 10 AWG	10,975.000 LF	_____.	_____.
0688	655.0610 Electrical Wire Lighting 12 AWG	4,464.000 LF	_____.	_____.
0690	655.0615 Electrical Wire Lighting 10 AWG	280.000 LF	_____.	_____.
0692	655.0620 Electrical Wire Lighting 8 AWG	9,930.000 LF	_____.	_____.
0694	655.0625 Electrical Wire Lighting 6 AWG	10,420.000 LF	_____.	_____.
0696	655.0635 Electrical Wire Lighting 2 AWG	160.000 LF	_____.	_____.
0698	655.0640 Electrical Wire Lighting 1 AWG	18.000 LF	_____.	_____.
0700	655.0700 Loop Detector Lead In Cable	20,435.000 LF	_____.	_____.
0702	655.0800 Loop Detector Wire	12,982.000 LF	_____.	_____.
0704	655.0900 Traffic Signal EVP Detector Cable	4,259.000 LF	_____.	_____.
0706	656.0201 Electrical Service Meter Breaker Pedestal (location) 041. STH 318 & Silvernail Rd.	1.000 EACH	_____.	_____.
0708	656.0201 Electrical Service Meter Breaker Pedestal (location) 051. IH 94 EB Ramps & STH 318	1.000 EACH	_____.	_____.
0710	656.0201 Electrical Service Meter Breaker Pedestal (location) 061. IH 94 WB Ramps & STH 318	1.000 EACH	_____.	_____.
0712	656.0201 Electrical Service Meter Breaker Pedestal (location) 071. IH 94 EB Ramps & CTH T	1.000 EACH	_____.	_____.



Proposal Schedule of Items

Proposal ID: 20240409007 Project(s): 1060-10-71, 1060-47-70, 1330-47-71, 2788-03-70

Federal ID(s): N/A, N/A, N/A, N/A

SECTION: 0001 Contract Items

Alt Set ID: Alt Mbr ID:

Proposal Line Number	Item ID Description	Approximate Quantity and Units	Unit Price	Bid Amount
0714	656.0201 Electrical Service Meter Breaker Pedestal (location) 081. IH 94 WB Ramps & CTH T	1.000 EACH	_____.	_____.
0716	656.0201 Electrical Service Meter Breaker Pedestal (location) 300. MBDMS670040	1.000 EACH	_____.	_____.
0718	656.0201 Electrical Service Meter Breaker Pedestal (location) 301. MBCCTV670244	1.000 EACH	_____.	_____.
0720	656.0501 Electrical Service Breaker Disconnect Box (location) 300. DMS670040	1.000 EACH	_____.	_____.
0722	656.0501 Electrical Service Breaker Disconnect Box (location) 301. CCTV670244	1.000 EACH	_____.	_____.
0724	657.0100 Pedestal Bases	15.000 EACH	_____.	_____.
0726	657.0255 Transformer Bases Breakaway 11 1/2-Inch Bolt Circle	8.000 EACH	_____.	_____.
0728	657.0305 Poles Type 2	3.000 EACH	_____.	_____.
0730	657.0310 Poles Type 3	2.000 EACH	_____.	_____.
0732	657.0420 Traffic Signal Standards Aluminum 13-FT	8.000 EACH	_____.	_____.
0734	657.0425 Traffic Signal Standards Aluminum 15-FT	4.000 EACH	_____.	_____.
0736	657.0430 Traffic Signal Standards Aluminum 10-FT	3.000 EACH	_____.	_____.
0738	657.0609 Luminaire Arms Single Member 4-Inch Clamp 6-FT	2.000 EACH	_____.	_____.
0740	658.0173 Traffic Signal Face 3S 12-Inch	64.000 EACH	_____.	_____.



Proposal Schedule of Items

Proposal ID: 20240409007 Project(s): 1060-10-71, 1060-47-70, 1330-47-71, 2788-03-70

Federal ID(s): N/A, N/A, N/A, N/A

SECTION: 0001 Contract Items

Alt Set ID: Alt Mbr ID:

Proposal Line Number	Item ID Description	Approximate Quantity and Units	Unit Price	Bid Amount
0742	658.0174 Traffic Signal Face 4S 12-Inch	14.000 EACH	_____.	_____.
0744	658.0416 Pedestrian Signal Face 16-Inch	6.000 EACH	_____.	_____.
0746	658.0500 Pedestrian Push Buttons	6.000 EACH	_____.	_____.
0748	658.5070 Signal Mounting Hardware (location) 021. IH 94 EB Ramps & CTH SS	1.000 EACH	_____.	_____.
0750	658.5070 Signal Mounting Hardware (location) 041. STH 318 & Silvernail Rd.	1.000 EACH	_____.	_____.
0752	658.5070 Signal Mounting Hardware (location) 051. IH 94 EB Ramps & STH 318	1.000 EACH	_____.	_____.
0754	658.5070 Signal Mounting Hardware (location) 061. IH 94 WB Ramps & STH 318	1.000 EACH	_____.	_____.
0756	658.5070 Signal Mounting Hardware (location) 071. IH 94 EB Ramps & CTH T	1.000 EACH	_____.	_____.
0758	658.5070 Signal Mounting Hardware (location) 081. IH 94 WB Ramps and CTH T	1.000 EACH	_____.	_____.
0760	659.1125 Luminaires Utility LED C	29.000 EACH	_____.	_____.
0762	659.5000.S Lamp, Ballast, LED, Switch Disposal by Contractor	127.000 EACH	_____.	_____.
0764	661.0201 Temporary Traffic Signals for Intersections (location) 041. STH 318 & Silvernail Rd.	1.000 EACH	_____.	_____.
0766	661.0201 Temporary Traffic Signals for Intersections (location) 051. IH 94 EB Ramps & STH 318	1.000 EACH	_____.	_____.





Proposal Schedule of Items

Proposal ID: 20240409007 Project(s): 1060-10-71, 1060-47-70, 1330-47-71, 2788-03-70

Federal ID(s): N/A, N/A, N/A, N/A

SECTION: 0001 Contract Items

Alt Set ID: Alt Mbr ID:

Proposal Line Number	Item ID Description	Approximate Quantity and Units	Unit Price	Bid Amount
0768	661.0201 Temporary Traffic Signals for Intersections (location) 061. IH 94 WB Ramps & STH 318	1.000 EACH	_____.	_____.
0770	661.0201 Temporary Traffic Signals for Intersections (location) 071. IH 94 EB Ramps & CTH T	1.000 EACH	_____.	_____.
0772	661.0201 Temporary Traffic Signals for Intersections (location) 081. IH 94 WB Ramps & CTH T	1.000 EACH	_____.	_____.
0774	662.1040.S Ramp Closure Gates 40-FT	2.000 EACH	_____.	_____.
0776	662.6020.S Ramp Closure Barricade Rack 2-Unit	2.000 EACH	_____.	_____.
0778	662.6030.S Ramp Closure Barricade Rack 3-Unit	1.000 EACH	_____.	_____.
0780	670.0101 Field System Integrator 071. Traffic Signal Interconnect	1.000 EACH	_____.	_____.
0782	670.0101 Field System Integrator 300. FTMS	1.000 EACH	_____.	_____.
0784	670.0201 ITS Documentation 071. Traffic Signal Interconnect	1.000 EACH	_____.	_____.
0786	670.0201 ITS Documentation 300. FTMS	1.000 EACH	_____.	_____.
0788	673.1200.S Install ITS Field Cabinet	1.000 EACH	_____.	_____.
0790	673.1225.S Install Pole Mounted Cabinet	2.000 EACH	_____.	_____.
0792	674.0300 Remove Cable	130.000 LF	_____.	_____.
0794	674.0400 Reinstall Cable	60.000 LF	_____.	_____.



Proposal Schedule of Items

Proposal ID: 20240409007 Project(s): 1060-10-71, 1060-47-70, 1330-47-71, 2788-03-70

Federal ID(s): N/A, N/A, N/A, N/A

SECTION: 0001 Contract Items

Alt Set ID: Alt Mbr ID:

Proposal Line Number	Item ID Description	Approximate Quantity and Units	Unit Price	Bid Amount
0796	675.0100 Install Controller Ramp Meter Processor Assembly	1.000 EACH	_____.	_____.
0798	675.0300 Install Mounted Controller Microwave Detector Assembly	4.000 EACH	_____.	_____.
0800	677.0130 Install Camera Pole 30-FT	1.000 EACH	_____.	_____.
0802	677.0150 Install Camera Pole 50-FT	3.000 EACH	_____.	_____.
0804	677.0200 Install Camera Assembly	4.000 EACH	_____.	_____.
0806	677.9051.S Removing 50-FT Camera Pole	1.000 EACH	_____.	_____.
0808	677.9200.S Removing CCTV Camera	1.000 EACH	_____.	_____.
0810	678.0006 Install Fiber Optic Cable Outdoor Plant 6-CT	2,630.000 LF	_____.	_____.
0812	678.0100.S Install Overhead Freeway DMS Full Matrix	1.000 EACH	_____.	_____.
0814	678.0200 Fiber Optic Splice Enclosure	3.000 EACH	_____.	_____.
0816	678.0300 Fiber Optic Splice	12.000 EACH	_____.	_____.
0818	678.0400 Fiber Optic Termination	82.000 EACH	_____.	_____.
0820	678.0501 Communication System Testing 071. Traffic Signal Interconnect	1.000 EACH	_____.	_____.
0822	678.0501 Communication System Testing 300. FTMS	1.000 EACH	_____.	_____.
0824	678.0600 Install Ethernet Switches	11.000 EACH	_____.	_____.



Proposal Schedule of Items

Proposal ID: 20240409007 Project(s): 1060-10-71, 1060-47-70, 1330-47-71, 2788-03-70

Federal ID(s): N/A, N/A, N/A, N/A

SECTION: 0001 Contract Items

Alt Set ID: Alt Mbr ID:

Proposal Line Number	Item ID Description	Approximate Quantity and Units	Unit Price	Bid Amount
0826	690.0150 Sawing Asphalt	9,472.000 LF	_____.	_____.
0828	690.0250 Sawing Concrete	49,548.000 LF	_____.	_____.
0830	715.0720 Incentive Compressive Strength Concrete Pavement	500.000 DOL	1.00000	500.00
0832	740.0440 Incentive IRI Ride	58,000.000 DOL	1.00000	58,000.00
0834	999.1950.S Bicycle Rack Asphalt or Concrete-Mounted	2.000 EACH	_____.	_____.
0838	SPV.0045 Special 001. Basic Traffic Queue Warning System	30.000 DAY	_____.	_____.
0840	SPV.0045 Special 002. Digital Speed Reduction System (DSRS)	291.000 DAY	_____.	_____.
0842	SPV.0060 Special 001. Tension Anchor Rods	64.000 EACH	_____.	_____.
0844	SPV.0060 Special 002. Remove Grout Pad	2.000 EACH	_____.	_____.
0846	SPV.0060 Special 003. Remove Debris and Regrade	1.000 EACH	_____.	_____.
0848	SPV.0060 Special 004. Adjust Sign	2.000 EACH	_____.	_____.
0850	SPV.0060 Special 005. U-Bolt	16.000 EACH	_____.	_____.
0852	SPV.0060 Special 006. Remove Catwalk	5.000 EACH	_____.	_____.
0854	SPV.0060 Special 007. Lower Structure	3.000 EACH	_____.	_____.
0856	SPV.0060 Special 008. Re-install Truss/Arm	2.000 EACH	_____.	_____.



Proposal Schedule of Items

Proposal ID: 20240409007 Project(s): 1060-10-71, 1060-47-70, 1330-47-71, 2788-03-70

Federal ID(s): N/A, N/A, N/A, N/A

SECTION: 0001 Contract Items

Alt Set ID: Alt Mbr ID:

Proposal Line Number	Item ID Description	Approximate Quantity and Units	Unit Price	Bid Amount
0858	SPV.0060 Special 009. Vertical Sign Support	1.000 EACH	_____.	_____.
0860	SPV.0060 Special 010. Strapping C-67-1570	2.000 EACH	_____.	_____.
0862	SPV.0060 Special 011. Catwalk Repair	1.000 EACH	_____.	_____.
0864	SPV.0060 Special 012. Replace Conduit Connector	6.000 EACH	_____.	_____.
0866	SPV.0060 Special 050. Survey Project	1.000 EACH	_____.	_____.
0868	SPV.0060 Special 051. Baseline CPM Progress Schedule	1.000 EACH	_____.	_____.
0870	SPV.0060 Special 052. Monthly CPM Progress Schedule Updates	14.000 EACH	_____.	_____.
0872	SPV.0060 Special 053. Traffic Control Close-Open Freeway Entrance Ramp	45.000 EACH	_____.	_____.
0874	SPV.0060 Special 054. Traffic Control Full Freeway Closure	10.000 EACH	_____.	_____.
0876	SPV.0060 Special 055. Mobilization Emergency Pavement Repair	8.000 EACH	_____.	_____.
0878	SPV.0060 Special 056. Field Facilities Office Space	1.000 EACH	_____.	_____.
0880	SPV.0060 Special 057. Utility Line Opening (ULO)	15.000 EACH	_____.	_____.
0882	SPV.0060 Special 058. Section Corner Monuments Special	2.000 EACH	_____.	_____.
0884	SPV.0060 Special 059. Remove and Reset Cable Barrier Post	1.000 EACH	_____.	_____.



Proposal Schedule of Items

Proposal ID: 20240409007 Project(s): 1060-10-71, 1060-47-70, 1330-47-71, 2788-03-70

Federal ID(s): N/A, N/A, N/A, N/A

SECTION: 0001 Contract Items

Alt Set ID: Alt Mbr ID:

Proposal Line Number	Item ID Description	Approximate Quantity and Units	Unit Price	Bid Amount
0886	SPV.0060 Special 060. Curb Ramp Grading and Shaping	9.000 EACH	_____.	_____.
0888	SPV.0060 Special 101. Concrete Barrier Transition to Curb	2.000 EACH	_____.	_____.
0890	SPV.0060 Special 102. Fastening Sewer Access Covers	6.000 EACH	_____.	_____.
0892	SPV.0060 Special 103. Reset Existing Bearings	18.000 EACH	_____.	_____.
0894	SPV.0060 Special 201. Install Poles Type 9	1.000 EACH	_____.	_____.
0896	SPV.0060 Special 202. Install Poles Type 9 Special	1.000 EACH	_____.	_____.
0898	SPV.0060 Special 203. Install Poles Type 10	2.000 EACH	_____.	_____.
0900	SPV.0060 Special 204. Install Poles Type 10 Special	9.000 EACH	_____.	_____.
0902	SPV.0060 Special 205. Install Poles Type 12	1.000 EACH	_____.	_____.
0904	SPV.0060 Special 206. Install Poles Type 13	4.000 EACH	_____.	_____.
0906	SPV.0060 Special 207. Install Monotube Arms 15-FT	1.000 EACH	_____.	_____.
0908	SPV.0060 Special 208. Install Monotube Arms 25-FT	2.000 EACH	_____.	_____.
0910	SPV.0060 Special 209. Install Monotube Arms 35-FT-Special	3.000 EACH	_____.	_____.
0912	SPV.0060 Special 210. Install Monotube Arms 45-FT-Special	7.000 EACH	_____.	_____.



Proposal Schedule of Items

Proposal ID: 20240409007 Project(s): 1060-10-71, 1060-47-70, 1330-47-71, 2788-03-70

Federal ID(s): N/A, N/A, N/A, N/A

SECTION: 0001 Contract Items

Alt Set ID: Alt Mbr ID:

Proposal Line Number	Item ID Description	Approximate Quantity and Units	Unit Price	Bid Amount
0914	SPV.0060 Special 211. Install Monotube Arms 50-FT	2.000 EACH	_____.	_____.
0916	SPV.0060 Special 212. Install Monotube Arms 55-FT	3.000 EACH	_____.	_____.
0918	SPV.0060 Special 213. Install Luminaire Arms Steel 15-FT	23.000 EACH	_____.	_____.
0920	SPV.0060 Special 214. Traffic Signal Reflective Backplate 3S	3.000 EACH	_____.	_____.
0922	SPV.0060 Special 215. Traffic Signal Reflective Backplate 4S	2.000 EACH	_____.	_____.
0924	SPV.0060 Special 216. Trnspt & Install State Furn Traffic Signal Cabinet STH 318 & Silvernail Road	1.000 EACH	_____.	_____.
0926	SPV.0060 Special 217. Trnspt & Install State Furn Traffic Signal Cabinet IH 94 EB Ramps & STH 318	1.000 EACH	_____.	_____.
0928	SPV.0060 Special 218. Trnspt & Install State Furn Traffic Signal Cabinet IH 94 WB Ramps & STH 318	1.000 EACH	_____.	_____.
0930	SPV.0060 Special 219. Trnspt & Install State Furn Traffic Signal Cabinet IH 94 EB Ramps & CTH T	1.000 EACH	_____.	_____.
0932	SPV.0060 Special 220. Trnspt & Install State Furn Traffic Signal Cabinet IH 94 WB Ramps & CTH T	1.000 EACH	_____.	_____.
0934	SPV.0060 Special 221. Trnspt & Install State Furn EVP Heads & Con Light STH 318 & Silvernail Road	1.000 EACH	_____.	_____.



Proposal Schedule of Items

Proposal ID: 20240409007 Project(s): 1060-10-71, 1060-47-70, 1330-47-71, 2788-03-70

Federal ID(s): N/A, N/A, N/A, N/A

SECTION: 0001 Contract Items

Alt Set ID: Alt Mbr ID:

Proposal Line Number	Item ID Description	Approximate Quantity and Units	Unit Price	Bid Amount
0936	SPV.0060 Special 222. Trnspt & Install State Furn EVP Heads & Con Light IH 94 EB Ramps & STH 318	1.000 EACH	_____.	_____.
0938	SPV.0060 Special 223. Trnspt & Install State Furn EVP Heads & Con Light IH 94 WB Ramps & STH 318	1.000 EACH	_____.	_____.
0940	SPV.0060 Special 224. Trnspt & Install State Furn EVP Heads & Con Light IH 94 EB Ramps & CTH T	1.000 EACH	_____.	_____.
0942	SPV.0060 Special 225. Trnspt & Install State Furn EVP Heads & Con Light IH 94 WB Ramps & CTH T	1.000 EACH	_____.	_____.
0944	SPV.0060 Special 226. Trnspt Traffic Signals & Inter Lighting Materials STH 318 & Silvernail Road	1.000 EACH	_____.	_____.
0946	SPV.0060 Special 227. Trnspt Traffic Signals & Inter Lighting Materials IH 94 EB Ramps & STH 318	1.000 EACH	_____.	_____.
0948	SPV.0060 Special 228. Trnspt Traffic Signals & Inter Lighting Materials IH 94 WB Ramps & STH 318	1.000 EACH	_____.	_____.
0950	SPV.0060 Special 229. Trnspt Traffic Signals & Inter Lighting Materials IH 94 EB Ramps & CTH T	1.000 EACH	_____.	_____.
0952	SPV.0060 Special 230. Trnspt Traffic Signals & Inter Lighting Materials IH 94 WB Ramps & CTH T	1.000 EACH	_____.	_____.
0954	SPV.0060 Special 231. Trnspt & Install S-F Radar Detection System IH 94 EB Ramps & CTH T	1.000 EACH	_____.	_____.



Proposal Schedule of Items

Proposal ID: 20240409007 Project(s): 1060-10-71, 1060-47-70, 1330-47-71, 2788-03-70

Federal ID(s): N/A, N/A, N/A, N/A

SECTION: 0001 Contract Items

Alt Set ID: Alt Mbr ID:

Proposal Line Number	Item ID Description	Approximate Quantity and Units	Unit Price	Bid Amount
0956	SPV.0060 Special 232. Trnspt & Install S-F Radar Detection System IH 94 WB Ramps & CTH T	1.000 EACH	_____.	_____.
0958	SPV.0060 Special 233. Airport Obstruction Lights L810	15.000 EACH	_____.	_____.
0960	SPV.0060 Special 234. Concrete Control Cabinet Bases Type 9 Special Super P	2.000 EACH	_____.	_____.
0962	SPV.0060 Special 235. Temporary EVP System STH 318 & Silvernail Road	1.000 EACH	_____.	_____.
0964	SPV.0060 Special 236. Temporary EVP System IH 94 EB Ramps & STH 318	1.000 EACH	_____.	_____.
0966	SPV.0060 Special 237. Temporary EVP System IH 94 WB Ramps & STH 318	1.000 EACH	_____.	_____.
0968	SPV.0060 Special 238. Temporary EVP System IH 94 EB Ramps & CTH T	1.000 EACH	_____.	_____.
0970	SPV.0060 Special 239. Temporary EVP System IH 94 WB Ramps & CTH T	1.000 EACH	_____.	_____.
0972	SPV.0060 Special 250. Remove and Reinstall Fiber Optic Pigtail STH 318 & Silvernail Road	1.000 EACH	_____.	_____.
0974	SPV.0060 Special 251. Remove and Reinstall Fiber Optic Pigtail IH 94 EB Ramps & STH 318	1.000 EACH	_____.	_____.
0976	SPV.0060 Special 252. Remove and Reinstall Fiber Optic Pigtail IH 94 WB Ramps & STH 318	1.000 EACH	_____.	_____.
0978	SPV.0060 Special 253. Remove and Reinstall Fiber Optic Pigtail IH 94 EB Ramps & CTH T	1.000 EACH	_____.	_____.





Proposal Schedule of Items

Proposal ID: 20240409007 Project(s): 1060-10-71, 1060-47-70, 1330-47-71, 2788-03-70

Federal ID(s): N/A, N/A, N/A, N/A

SECTION: 0001 Contract Items

Alt Set ID: Alt Mbr ID:

Proposal Line Number	Item ID Description	Approximate Quantity and Units	Unit Price	Bid Amount
0980	SPV.0060 Special 254. Remove and Reinstall Fiber Optic Pigtail IH 94 WB Ramps & CTH T	1.000 EACH	_____.	_____.
0982	SPV.0060 Special 255. Relocate Existing Pull Box	1.000 EACH	_____.	_____.
0984	SPV.0060 Special 300. Remove Pole	2.000 EACH	_____.	_____.
0986	SPV.0060 Special 301. Ground Rod	5.000 EACH	_____.	_____.
0988	SPV.0060 Special 302. Refocus Vehicle Detector Assembly	24.000 EACH	_____.	_____.
0990	SPV.0060 Special 303. Removing Controller Cabinet Base	1.000 EACH	_____.	_____.
0992	SPV.0060 Special 304. Removing Controller Cabinet	1.000 EACH	_____.	_____.
0994	SPV.0060 Special 401. Modify Lighting Control Cabinets 120/240	1.000 EACH	_____.	_____.
0996	SPV.0060 Special 402. Maintenance of Lighting Systems (1060-47-70)	1.000 EACH	_____.	_____.
0998	SPV.0060 Special 403. Lighting System Integrator (1060-47-70)	1.000 EACH	_____.	_____.
1000	SPV.0060 Special 404. Lighting System Survey (1060-47-70)	1.000 EACH	_____.	_____.
1002	SPV.0090 Special 001. Concrete Barrier 51-Inch Special	688.000 LF	_____.	_____.
1004	SPV.0090 Special 002. Marking Epoxy 4-Inch Black Non Grooved	1,046.000 LF	_____.	_____.



Proposal Schedule of Items

Proposal ID: 20240409007 Project(s): 1060-10-71, 1060-47-70, 1330-47-71, 2788-03-70

Federal ID(s): N/A, N/A, N/A, N/A

SECTION: 0001 Contract Items

Alt Set ID: Alt Mbr ID:

Proposal Line Number	Item ID Description	Approximate Quantity and Units	Unit Price	Bid Amount
1006	SPV.0090 Special 003. Marking Epoxy 6-Inch Black Non Grooved	1,896.000 LF	_____.	_____.
1008	SPV.0090 Special 004. Marking Epoxy 8-Inch Black Non Grooved	221.000 LF	_____.	_____.
1010	SPV.0090 Special 005. Marking Epoxy 10-Inch Black Non Grooved	290.000 LF	_____.	_____.
1012	SPV.0090 Special 006. Concrete Barrier Wall Epoxy Crack Sealing	850.000 LF	_____.	_____.
1014	SPV.0090 Special 300. Outdoor Rated Network Cable	360.000 LF	_____.	_____.
1016	SPV.0090 Special 401. Cable Aerial Aluminum 6 AWG Triplex	1,030.000 LF	_____.	_____.
1018	SPV.0165 Special 001. Repair Galvanized Coating	26.000 SF	_____.	_____.
1020	SPV.0165 Special 002. Wall Modular Block Mechanically Stabilized Earth R-67-159	1,240.000 SF	_____.	_____.
1022	SPV.0165 Special 003. Concrete Barrier Wall Surface Repair	640.000 SF	_____.	_____.
1024	SPV.0180 Special 001. Methacrylate Flood Seal	8,944.000 SY	_____.	_____.
1026	SPV.0180 Special 002. Resin Binder High Friction Surface Treatment	7,274.000 SY	_____.	_____.
1028	SPV.0180 Special 003. Micromilling for Base Patching	45,212.000 SY	_____.	_____.
1030	SPV.0195 Special 001. HMA Longitudinal Joint Repair	2,100.000 TON	_____.	_____.



Proposal Schedule of Items

Proposal ID: 20240409007 Project(s): 1060-10-71, 1060-47-70, 1330-47-71, 2788-03-70

Federal ID(s): N/A, N/A, N/A, N/A

SECTION: 0001 Contract Items

Alt Set ID: Alt Mbr ID:

Proposal Line Number	Item ID Description	Approximate Quantity and Units	Unit Price	Bid Amount
1032	SPV.0195 Special 002. Asphaltic Repair	183.000 TON	_____.	_____.
	<b>Section: 0001</b>		<b>Total:</b>	_____.
			<b>Total Bid:</b>	_____.





# Wisconsin Department of Transportation

April 5, 2024

Division of Transportation Systems Development  
Bureau of Project Development  
4822 Madison Yards Way, 4<sup>th</sup> Floor South  
Madison, WI 53705

Telephone: (608) 266-1631  
Facsimile (FAX): (608) 266-8459

## NOTICE TO ALL CONTRACTORS:

**Proposal #07: 1060-10-71**  
**IH 94 East West Freeway**  
**CTH T and CTH JJ (B-67-240,245)**  
**IH 94**  
**Waukesha County**

**1060-47-70**  
**IH 94 East West Freeway**  
**STH 83 to STH 16**  
**IH 94**  
**Waukesha County**

**1330-47-71**  
**C Delafield, State Road 83**  
**Nagawaukee Park and Ride Lot**  
**Off Sys**  
**Waukesha County**

**2788-03-70**  
**C Waukesha Meadowbrook Road**  
**Rolling Ridge Dr to IH 94 EB Ramps**  
**STH 318**  
**Waukesha County**

## Letting of April 9, 2024

This is Addendum No. 03, which provides for the following:

### Schedule of Items:

Revised Bid Item Quantities					
Bid Item	Item Description	Unit	Proposal Total Prior to Addendum	Proposal Quantity Change (-)	Proposal Total After Addendum
531.6120	Foundation Two-Shaft Type FF-II (structure) 001. S-67-420	EACH	1	1	2
532.6120	Truss Full Span 4-Chord Type II (structure) 001. S-67-420	EACH	2	-1	1

### Schedule of Items

Attached, dated April 5, 2024, are the revised Schedule of Items Page 10.

The responsibility for notifying potential subcontractors and suppliers of these changes remains with the prime contractor.

Sincerely,

*Mike Coleman*

Proposal Development Specialist  
Proposal Management Section

END OF ADDENDUM



Proposal Schedule of Items

Proposal ID: 20240409007 Project(s): 1060-10-71, 1060-47-70, 1330-47-71, 2788-03-70

Federal ID(s): N/A, N/A, N/A, N/A

SECTION: 0001 Contract Items

Alt Set ID: Alt Mbr ID:

Proposal Line Number	Item ID Description	Approximate Quantity and Units	Unit Price	Bid Amount
0260	524.0624 Apron Endwalls for Culvert Pipe Salvaged 24-Inch	1.000 EACH	_____.	_____.
0262	530.0112 Culvert Pipe Corrugated Polyethylene 12-Inch	131.000 LF	_____.	_____.
0264	531.1100 Concrete Masonry Ancillary Structures Type NS	36.000 CY	_____.	_____.
0266	531.1140 Steel Reinforcement HS Ancillary Structures Type NS	4,968.000 LB	_____.	_____.
0268	531.2020 Drilling Shaft 20-Inch	7.000 LF	_____.	_____.
0270	531.2024 Drilling Shaft 24-Inch	304.000 LF	_____.	_____.
0272	531.2036 Drilling Shaft 36-Inch	118.000 LF	_____.	_____.
0274	531.4030 Foundation Camera Pole 30-FT	1.000 EACH	_____.	_____.
0276	531.4050 Foundation Camera Pole 50-FT	3.000 EACH	_____.	_____.
0278	531.6120 Foundation Two-Shaft Type FF-II (structure) 001. S-67-420	2.000 EACH	_____.	_____.
0280	532.6120 Truss Full Span 4-Chord Type II (structure) 001. S-67-420	1.000 EACH	_____.	_____.
0282	601.0115 Concrete Curb Type G	218.000 LF	_____.	_____.
0284	601.0411 Concrete Curb & Gutter 30-Inch Type D	768.000 LF	_____.	_____.
0286	601.0413 Concrete Curb & Gutter 6-Inch Sloped 30-Inch Type G	2,254.000 LF	_____.	_____.