



Wisconsin Department of Transportation

May 9, 2024

Division of Transportation Systems Development

Bureau of Project Development
4822 Madison Yards Way, 4th Floor South
Madison, WI 53705

Telephone: (608) 266-1631
Facsimile (FAX): (608) 266-8459

NOTICE TO ALL CONTRACTORS:

Proposal #02: 1071-07-79, WISC2024351
La Crosse – Sparta
(Safety Rest Area 16 Sparta Building)
IH 90
Monroe County

Letting of May 14, 2024

This is Addendum No. 02, which provides for the following:

Special Provisions:

Revised Special Provisions	
Article No.	Description
28	Site Furnishings
40	Rest Area Building General, Item SPV.0060.11; Maintenance Building General, Item SPV.0060.15
42	Rest Area Building HVAC, Item SPV.0060.13; Maintenance Building HVAC, Item SPV.0060.17
43	Rest Area Building Electrical, Item SPV.0060.14; Maintenance Building Electrical, Item SPV.0060.18

Plan Sheets:

Revised Plan Sheets	
Plan Sheet	Plan Sheet Title (brief description of changes to sheet)
77	Revised Building Architectural Plan (A1-50) – Updated manual roller shade profile information
78	Revised Building Architectural Plan (A1-51) – Clarified mounting and revised comments in furniture schedule
208	Revised Building Architectural Plan (E5-14) – Add circuit for data rack receptacle to panel schedule
213	Revised Building Architectural Plan (T2-00) – Updated technology plans & keynote legend
215	Revised Building Architectural Plan (T4-12) – Updated main building cabinet elevation & added maintenance shed cabinet elevation
216	Revised Building Architectural Plan (T5-11) – Updated riser diagrams
217	Revised Building Architectural Plan (T6-11) – Updated schedules

254	Revised Building Architectural Plan (G-E2-13) – Add quad receptacle at data rack location
255	Revised Building Architectural Plan (G-T2-13) – Updated technology plans & keynote legend

The responsibility for notifying potential subcontractors and suppliers of these changes remains with the prime contractor.

Sincerely,

Mike Coleman

Proposal Development Specialist
Proposal Management Section

ADDENDUM NO. 02

1071-07-79

May 9, 2024

Special Provisions

28. Site Furnishings.

*Replace section 2.2 (f) (2) under subsection titled **Part 2 Products** under section titled **Section 32 33 00** –*

Site Furnishings with the following:

2. Model: Concrete Trash Receptacle with Domed Plastic Top, Model No. TF1150 and 39 Gal. Plastic Liner, Model No. TF1635

40. Rest Area Building General, Item SPV.0060.11; Maintenance Building General, Item SPV.0060.15.

Add Section 07 42 13.23 - Metal Composite Material Wall Panels

Section 07 42 13.23 - Metal Composite Material Wall Panels

PART 1 GENERAL

1.1 SECTION INCLUDES

- A. Exterior cladding consisting of formed metal composite material (MCM) sheet, secondary supports, and anchors to structure, attached to solid backup.
- B. Matching flashing and trim.

1.2 RELATED REQUIREMENTS

- A. Section 07 25 00 - Weather Barriers: Water-resistive barrier behind wall panel system.
- B. Section 07 62 00 - Sheet Metal Flashing and Trim: Metal flashing components integrated with this wall system.

1.3 REFERENCE STANDARDS

- A. ASTM A36/A36M - Standard Specification for Carbon Structural Steel; 2019.
- B. ASTM A123/A123M - Standard Specification for Zinc (Hot-Dip Galvanized) Coatings on Iron and Steel Products; 2017.
- C. ASTM A153/A153M - Standard Specification for Zinc Coating (Hot-Dip) on Iron and Steel Hardware; 2023.
- D. ASTM A276/A276M - Standard Specification for Stainless Steel Bars and Shapes; 2017.
- E. ASTM A480/A480M - Standard Specification for General Requirements for Flat-Rolled Stainless and Heat-Resisting Steel Plate, Sheet, and Strip; 2022a.
- F. ASTM A653/A653M - Standard Specification for Steel Sheet, Zinc-Coated (Galvanized) or Zinc-Iron Alloy-Coated (Galvannealed) by the Hot-Dip Process; 2023.
- G. ASTM A666 - Standard Specification for Annealed or Cold-Worked Austenitic Stainless Steel Sheet, Strip, Plate, and Flat Bar; 2023.
- H. ASTM A792/A792M - Standard Specification for Steel Sheet, 55% Aluminum-Zinc Alloy-Coated by the Hot-Dip Process; 2022.

- I. ASTM B209/B209M - Standard Specification for Aluminum and Aluminum-Alloy Sheet and Plate; 2021a.
- J. ASTM B221 - Standard Specification for Aluminum and Aluminum-Alloy Extruded Bars, Rods, Wire, Profiles, and Tubes; 2021.
- K. ASTM B221M - Standard Specification for Aluminum and Aluminum-Alloy Extruded Bars, Rods, Wire, Profiles, and Tubes (Metric); 2021.
- L. ASTM D523 - Standard Test Method for Specular Gloss; 2014 (Reapproved 2018).
- M. ASTM D1781 - Standard Test Method for Climbing Drum Peel for Adhesives; 1998 (Reapproved 2021).
- N. ASTM D1929 - Standard Test Method for Determining Ignition Temperature of Plastics; 2023.
- O. ASTM D2244 - Standard Practice for Calculation of Color Tolerances and Color Differences from Instrumentally Measured Color Coordinates; 2023.
- P. ASTM D4145 - Standard Test Method for Coating Flexibility of Prepainted Sheet; 2010 (Reapproved 2022).
- Q. ASTM D4214 - Standard Test Methods for Evaluating the Degree of Chalking of Exterior Paint Films; 2023.
- R. ASTM E84 - Standard Test Method for Surface Burning Characteristics of Building Materials; 2023b.
- S. NFPA 285 - Standard Fire Test Method for Evaluation of Fire Propagation Characteristics of Exterior Wall Assemblies Containing Combustible Components; 2023.

1.4 ADMINISTRATIVE REQUIREMENTS

- A. Pre-Installation Meeting: Convene one week before starting work of this section to verify project requirements, coordinate with installers of other work, establish condition and completeness of building substrate, and review manufacturers' installation instructions and warranty requirements.
 - 1. Require attendance by the installer and relevant sub-contractors.
 - 2. Include MCM sheet manufacturer's representative and wall system manufacturer's representative to review storage and handling procedures.
 - 3. Review in detail truck transportation, parking, vertical transportation, schedule, personnel, installation of adjacent materials and substrate.
 - 4. Review procedures for protection of work and other construction.

1.5 SUBMITTALS

- A. See Section 01 30 00 - Administrative Requirements for submittal procedures.
- B. Product Data - MCM Sheets: Manufacturer's data sheets on each product to be used, including thickness, physical characteristics, and finish, and:
 - 1. Finish manufacturer's data sheet showing physical and performance characteristics.
 - 2. Storage and handling requirements and recommendations.
 - 3. Fabrication instructions and recommendations.
 - 4. Specimen warranty for finish, as specified herein.
- C. Product Data - Wall System: Manufacturer's data sheets on each product to be used, including:
 - 1. Physical characteristics of components shown on shop drawings.

2. Storage and handling requirements and recommendations.
 3. Installation instructions and recommendations.
 4. Specimen warranty for wall system, as specified herein.
- D. Shop Drawings: Show layout and elevations, dimensions and thickness of panels, connections, details and location of joints, sealants and gaskets, method of anchorage, support clips, exposed fasteners, number of anchors, supports, reinforcement, trim, flashings, and accessories.
1. Indicate panel numbering system.
 2. Differentiate between shop and field fabrication.
 3. Indicate substrates and adjacent work with which the wall system must be coordinated.
 4. Include large-scale details of anchorages and connecting elements.
 5. Include large-scale details or schematic, exploded or isometric diagrams to fully explain flashing at a scale of not less than 1-1/2 inches per 12 inches.
 6. Include design engineer's stamp or seal on shop drawings for attachments and anchors.
- E. Verification Samples: For each finish product specified, submit at least three samples, minimum size 12 inch square, and representing actual product in color and texture.
- F. Manufacturer's Field Reports: Provide within 48 hours of field review. State what was observed and what changes, if any, were requested or required.
- G. Maintenance Data: Care of finishes and warranty requirements.
- H. Executed Warranty: Submit warranty and ensure that forms have been completed in Owner's name and registered with manufacturer.

1.6 DELIVERY, STORAGE, AND HANDLING

- A. Deliver products in manufacturer's original, unopened, undamaged containers with identification labels intact.
1. Protect finishes by applying heavy-duty removable plastic film during production.
 2. Package for protection against transportation damage.
 3. Provide markings to identify components consistently with drawings.
 4. Exercise care in unloading, storing, and installing panels to prevent bending, warping, twisting, and surface damage.
- B. Store products protected from exposure to harmful weather conditions and at temperature conditions recommended by manufacturer.
1. Store in well-ventilated space out of direct sunlight.
 2. Protect from moisture and condensation with tarpaulins or other suitable weathertight covering installed to provide ventilation.
 3. Store at a slope to ensure positive drainage of accumulated water.
 4. Do not store in enclosed space where ambient temperature can exceed 120 degrees F.
 5. Avoid contact with other materials that might cause staining, denting, or other surface damage.

1.7 WARRANTY

- A. MCM Sheet Manufacturer's Finish Warranty: Provide manufacturer's written warranty stating that the finish will perform as follows for minimum of 20 years:
 - 1. Chalking: No more than that represented by a No. 8 rating based on ASTM D4214.
 - 2. Color Retention: No fading or color change in excess of 5 Hunter color difference units, calculated in accordance with ASTM D2244.
 - 3. Gloss Retention: Minimum of 30 percent gloss retention, when tested in accordance with ASTM D523.

PART 2 PRODUCTS

2.1 MANUFACTURERS

- A. Basis of Design: Alucobond Rainscreen Composite Wall Panel System.
- B. Metal Composite Material (MCM) Sheet Manufacturers:
 - 1. ALUCOBOND by 3A Composites USA; ALUCOBOND PLUS: www.alucobondusa.com/#sle.
 - 2. Alfrex, LLC; Alfrex fr: www.alfrexusa.com/#sle.
 - 3. ALPOLIC Materials; ALPOLIC/fr (Fire Retardant core): www.alpolic-americas.com/#sle.
 - 4. Alucoil North America LLC; larson by Alucoil, FR Core (fire resistant): www.alucoilnorthamerica.com/#sle.
 - 5. Arconic Architectural Products, Inc; Reynobond: www.arconic.com.com/#sle.
 - 6. Citadel Architectural Products, Inc; Envelope 2000: www.citadelap.com/#sle.
 - 7. Fairview Architectural LLC; VitraBond (Fire Rated): www.fairview-na.com/#sle.
 - 8. Metal Construction Association: www.metalconstruction.org.
 - 9. Substitutions: See Section 01 60 00 - Product Requirements.
- C. Wall Panel System Manufacturers:
 - 1. Listed Material Sheet Manufacturers.
 - 2. Americlad: www.americlad.com.
 - 3. Kanalco Ltd: www.kanalco.com/#sle.
 - 4. Laminators Inc: www.laminators.com.
 - 5. Metal Construction Association: www.metalconstruction.org.
 - 6. Metal Design Systems, Inc: www.metaldesignsystems.com.
 - 7. Petersen Aluminum Corporation: www.pac-clad.com/#sle.
 - 8. Progressive Building Systems: www.pbsmetals.com.
 - 9. Protean: www.protean.com.
 - 10. SGH Concepts: sghconcepts.com.
 - 11. Specialty Systems, Inc: www.specialtysystemsinc.com.
 - 12. TFC Canopy: www.tfccanopy.com.
 - 13. Substitutions: See Section 01 60 00 - Product Requirements.

2.2 WALL PANEL SYSTEM

- A. Wall Panel System: Metal panels, fasteners, and anchors designed to be supported by framing or other substrate provided by others; provide installed panel system capable of maintaining specified performance without defects, damage, or failure.
 - 1. Provide structural design by or under direct supervision of a Structural Engineer licensed in the State in which the Project is located.
 - 2. Provide panel jointing using a reveal joint without gaskets or sealant.
 - 3. Anchor panels to supporting framing without exposed fasteners.
- B. Performance Requirements
 - 1. Thermal Movement: Provide for free and noiseless vertical and horizontal thermal movement due to expansion and contraction under material temperature range of minus 20 degrees F to 180 degrees F without buckling, opening of joints, undue stress on fasteners, or other detrimental effects; allow for ambient temperature at time of fabrication, assembly, and erection procedures.
- C. Panels: 1 inch deep pans formed of metal composite material sheet by routing back edges of sheet, removing corners, and folding edges.
 - 1. Reinforce corners with riveted aluminum angles.
 - 2. Provide concealed attachment to supporting structure by adhering attachment members to back of panel; attachment members may also function as stiffeners.
 - 3. Maintain maximum panel bow of 0.8 percent of panel dimension in width and length; provide stiffeners of sufficient size and strength to maintain panel flatness without showing local stresses or read-through on panel face.
 - 4. Secure members to back face of panels using structural silicone sealant approved by MCM sheet manufacturer.
 - 5. Fabricate panels under controlled shop conditions.
 - 6. Where final dimensions cannot be established by field measurement before commencement of manufacturing, make allowance for field adjustments without requiring field fabrication of panels.
 - 7. Fabricate as indicated on drawings and as recommended by MCM sheet manufacturer.
 - a. Make panel lines, breaks, curves, and angles sharp and true.
 - b. Keep plane surfaces free from warp or buckle.
 - c. Keep panel surfaces free of scratches or marks caused during fabrication.
 - 8. Provide joint details providing a watertight and structurally sound wall panel system that allows no uncontrolled water penetration on inside face of panel system.

2.3 MATERIALS

- A. Metal Composite Material (MCM) Sheet: Two sheets of aluminum sandwiching a core of extruded thermoplastic material; no foamed insulation material content.
 - 1. Alternate Metal Composite Material (MCM) Sheet: Citadel Architectural Products, Inc; Envelope 2000 is considered equivalent to other MCM product materials specified.
 - 2. Overall Sheet Thickness: 4 mm, minimum.
 - 3. Face Sheet Thickness: 0.019 inch, minimum.
 - 4. Bond and Peel Strength: No adhesive failure of the bond between the core and the skin nor cohesive failure of the core itself below 22.4 inch-pound/inch with no

degradation in bond performance, when tested in accordance with ASTM D1781, simulating resistance to panel delamination, after 8 hours of submersion in boiling water and after 21 days of immersion in water at 70 degrees F.

5. Surface Burning Characteristics: Flame spread index of 25, maximum; smoke developed index of 450 maximum; when tested in accordance with ASTM E84.
 6. Flammability: Self-ignition temperature of 650 degrees F or greater when tested in accordance with ASTM D1929.
 7. Factory Finish: One coat fluoropolymer resin coating, approved by the coating manufacturer for the length of warranty specified for the project, and applied by coil manufacturing facility that specializes in coil applied finishes.
 - a. Coating Flexibility: Pass ASTM D4145 minimum 1T-bend, at time of manufacturing.
 - b. Long-Term Performance: Not less than that specified under WARRANTY in PART 1.
 8. Colors: As scheduled on the drawings.
- B. Metal Framing Members: Include sub-girts, zee-clips, base and sill angles and channels, hat-shaped and rigid channels, and furring channels required for complete installation.
1. Provide material strength, dimensions, configuration as required to meet applied loads and in compliance with applicable building code.
 2. Sheet Steel Components: ASTM A653/A653M galvanized to G90/Z275 or zinc-iron alloy-coated to A60/ZF180; or ASTM A792/A792M aluminum-zinc coated to AZ60/AZM180.
 3. Stainless Steel Sheet Components: ASTM A480/A480M.
 4. Aluminum Components: ASTM B209/B209M; or ASTM B221 (ASTM B221M).
 5. Panel Support Framing: See Section 05 40 00.

2.4 FINISHES

- A. Factory Finish: Two coat fluoropolymer resin coating, approved by coating manufacturer for length of warranty specified for project, and applied by coil manufacturing facility that specializes in coil applied finishes.
1. Coating Flexibility: Pass ASTM D4145 minimum 1T Bend at time of manufacturing.
 2. Long-Term Performance: Not less than that specified under WARRANTY in PART 1.

2.5 ACCESSORIES

- A. Flashing: Sheet aluminum; 0.040 inch thick, minimum; finish and color to match MCM sheet; see Section 07 62 00 for additional requirements.
- B. Support for Cladding and Continuous Insulation: Thermal clips.
1. Thermally-broken clips that provide attachment support for girts, angles, channels, and other cladding support framing.
 2. Galvanized Steel Support Clip: 14 gauge, 0.0747 inch, G90/Z275 galvanized support clip complying with ASTM A653/A653M, with integral glass fiber reinforced polyamide thermal isolator pad.
 3. Fasteners: As recommended by clip manufacturer.
- C. Anchors, Clips, and Accessories: Use one of the following:

1. Stainless steel complying with ASTM A276/A276M, ASTM A480/A480M, or ASTM A666.
 2. Steel complying with ASTM A36/A36M and hot-dip zinc coating to ASTM A153/A153M.
 3. Steel complying with ASTM A36/A36M and hot-dip galvanized to ASTM A123/A123M, with Coating Thickness Grade of 100.
- D. Fasteners:
1. Exposed Fasteners: Stainless steel; permitted only where absolutely unavoidable and subject to prior approval of the Architect.
 2. Screws: Self-drilling or self-tapping Type 410 stainless steel or zinc-alloy steel hex washer head, with EPDM or PVC washer under heads of fasteners bearing on weather side of metal wall panels.
 3. Bolts: Stainless steel.
 4. Fasteners for Flashing and Trim: Blind fasteners of high-strength aluminum or stainless steel.
- E. Provide panel system manufacturer's and installer's standard corrosion resistant accessories, including fasteners, clips, anchorage devices, and attachments.

PART 3 EXECUTION

3.1 EXAMINATION

- A. Examine dimensions, tolerances, and interfaces with other work.
1. Verify that weather barrier system is properly installed; see Section 07 25 00 for requirements.
- B. Examine substrate on-site to determine that conditions are acceptable for product installation in accordance with manufacturer's written instructions.
- C. If substrate preparation is the responsibility of another installer, notify Architect of unsatisfactory preparation before proceeding.
- D. Notify Architect in writing of conditions detrimental to proper and timely completion of work, and do not proceed with erection until unsatisfactory conditions have been corrected.

3.2 PREPARATION

- A. Protect adjacent work areas and finish surfaces from damage during installation.

3.3 INSTALLATION

- A. Do not install products that are defective, including warped, bowed, dented, and broken members, and members with damaged finishes.
- B. Comply with instructions and recommendations of MCM sheet manufacturer and wall system manufacturer, as well as with approved shop drawings.
- C. Install wall system securely allowing for necessary thermal and structural movement; comply with wall system manufacturer's instructions for installation of concealed fasteners.
- D. Do not handle or tool products during erection in manner that damages finish, decreases strength, or results in visual imperfection or failure in performance. Return component parts that require alteration to shop for refabrication, if possible, or for replacement with new parts.
- E. Do not form panels in field unless required by wall system manufacturer and approved by the Architect; comply with MCM sheet manufacturer's instructions and recommendations for field forming.

- F. Separate dissimilar metals; use gasket fasteners, isolation shims, or isolation tape where needed to eliminate possibility of electrolytic action between metals.
- G. Install flashings as indicated on shop drawings. At flashing butt joints, provide a lap strap under flashing and seal lapped surfaces with a full bed of non-hardening sealant.
- H. Install square, plumb, straight, and true, accurately fitted, with tight joints and intersections maintaining the following installation tolerances:
 - 1. Variation From Plane or Location: 1/2 inch in 30 feet of length and up to 3/4 inch in 300 feet, maximum.
 - 2. Deviation of Vertical Member From True Line: 0.1 inch in 25 feet run, maximum.
 - 3. Deviation of Horizontal Member From True Line: 0.1 inch in 25 feet run, maximum.
 - 4. Offset From True Alignment Between Two Adjacent Members Abutting End To End, In Line: 0.03 inch, maximum.
- I. Replace damaged products.
 - 1. Exception: Field repairs of minor damage to finishes are permitted only when approved in writing by Architect, panel manufacturer, and fabricator.
 - 2. Field Repairs to Finishes: Using materials and methods sufficient that repairs are not discernible when viewed at distance of 10 feet under all typical light conditions experienced at the project.

3.4 FIELD QUALITY CONTROL

- A. See Section 01 40 00 - Quality Requirements for additional requirements.
- B. Wall System Manufacturer's Field Services: Provide field services consisting of product use recommendations and periodic site visits for inspection of product installation in accordance with instructions.
- C. Site Visits: Schedule two site visits during execution of installation.

3.5 CLEANING

- A. Ensure weep holes and drainage channels are unobstructed and free of dirt and sealants.
- B. Remove protective film after installation of joint sealers, after cleaning of adjacent materials, and immediately prior to completion of work.
- C. Remove temporary coverings and protection of adjacent work areas.
- D. Clean installed products in accordance with manufacturer's instructions.

3.6 PROTECTION

PART 1 - GENERAL

1.1 RELATED DOCUMENTS

- A. Drawings and general provisions of the Contract, including General and Supplementary Conditions and Division 1 Specification Sections, apply to this Section.

1.2 SUMMARY

- A. This Section includes commercial door hardware for the following:

1. Swinging doors.
- B. Door hardware includes, but is not necessarily limited to, the following:
1. Mechanical door hardware.
 2. Cylinders specified for doors in other sections.
- C. Related Sections:
1. Division 08 Section "Hollow Metal Doors and Frames".
 2. Division 08 Section "Aluminum-Framed Entrances and Storefronts".
- D. Codes and References: Comply with the version year adopted by the Authority Having Jurisdiction.
1. ANSI A117.1 - Accessible and Usable Buildings and Facilities.
 2. ICC/IBC - International Building Code.
 3. NFPA 70 - National Electrical Code.
 4. NFPA 80 - Fire Doors and Windows.
 5. NFPA 101 - Life Safety Code.
 6. NFPA 105 - Installation of Smoke Door Assemblies.
 7. State Building Codes, Local Amendments.
- E. Standards: All hardware specified herein shall comply with the following industry standards as applicable. Any undated reference to a standard shall be interpreted as referring to the latest edition of that standard:
1. ANSI/BHMA Certified Product Standards - A156 Series.
 2. UL10C - Positive Pressure Fire Tests of Door Assemblies.
 3. ANSI/UL 294 - Access Control System Units.
 4. UL 305 - Panic Hardware.
 5. ANSI/UL 437- Key Locks.

1.3 SUBMITTALS

- A. Product Data: Manufacturer's product data sheets including installation details, material descriptions, dimensions of individual components and profiles, operational descriptions and finishes.
- B. Door Hardware Schedule: Prepared by or under the supervision of supplier, detailing, fabrication and assembly of door hardware, as well as procedures and diagrams. Coordinate the final Door Hardware Schedule with doors, frames, and related work to ensure proper size, thickness, hand, function, and finish of door hardware.
1. Format: Comply with scheduling sequence and vertical format in DHI's "Sequence and Format for the Hardware Schedule."
 2. Organization: Organize the Door Hardware Schedule into door hardware sets indicating complete designations of every item required for each door or opening. Organize door hardware sets in same order as in the Door Hardware Sets at the end of Part 3. Submittals that do not follow the same format and order as the Door Hardware Sets will be rejected and subject to resubmission.
 3. Content: Include the following information:
 - a. Type, style, function, size, label, hand, and finish of each door hardware item.

- b. Manufacturer of each item.
 - c. Fastenings and other pertinent information.
 - d. Location of door hardware set, cross-referenced to Drawings, both on floor plans and in door and frame schedule.
 - e. Explanation of abbreviations, symbols, and codes contained in schedule.
 - f. Mounting locations for door hardware.
 - g. Door and frame sizes and materials.
 - h. Warranty information for each product.
4. Submittal Sequence: Submit the final Door Hardware Schedule at earliest possible date, particularly where approval of the Door Hardware Schedule must precede fabrication of other work that is critical in the Project construction schedule. Include Product Data, Samples, Shop Drawings of other work affected by door hardware, and other information essential to the coordinated review of the Door Hardware Schedule.
- C. Keying Schedule: After a keying meeting with the owner has taken place prepare a separate keying schedule detailing final instructions. Submit the keying schedule in electronic format. Include keying system explanation, door numbers, key set symbols, hardware set numbers and special instructions. Owner must approve submitted keying schedule prior to the ordering of permanent cylinders/cores.
- D. Informational Submittals:
- 1. Product Test Reports: Indicating compliance with cycle testing requirements, based on evaluation of comprehensive tests performed by manufacturer and witnessed by a qualified independent testing agency.
- E. Operating and Maintenance Manuals: Provide manufacturers operating and maintenance manuals for each item comprising the complete door hardware installation in quantity as required in Division 01, Closeout Procedures.

1.4 QUALITY ASSURANCE

- A. Manufacturers Qualifications: Engage qualified manufacturers with a minimum 5 years of documented experience in producing hardware and equipment similar to that indicated for this Project and that have a proven record of successful in-service performance.
- B. Certified Products: Where specified, products must maintain a current listing in the Builders Hardware Manufacturers Association (BHMA) Certified Products Directory (CPD).
- C. Installer Qualifications: A minimum 3 years documented experience installing both standard and electrified door hardware similar in material, design, and extent to that indicated for this Project and whose work has resulted in construction with a record of successful in-service performance.
- D. Door Hardware Supplier Qualifications: Experienced commercial door hardware distributors with a minimum 5 years documented experience supplying both mechanical and electromechanical hardware installations comparable in material, design, and extent to that indicated for this Project. Supplier recognized as a factory direct distributor by the manufacturers of the primary materials with a warehousing facility in Project's vicinity. Supplier to have on staff a certified Architectural Hardware Consultant (AHC) available during the course of the Work to consult with Contractor, Architect, and Owner concerning both standard and electromechanical door hardware and keying.
- E. Source Limitations: Obtain each type and variety of door hardware specified in this section from a single source unless otherwise indicated.

1. Electrified modifications or enhancements made to a source manufacturer's product line by a secondary or third party source will not be accepted.
- F. Each unit to bear third party permanent label indicating compliance with the referenced testing standards.
- G. Keying Conference: Conduct conference to comply with requirements in Division 01 Section "Project Meetings." Keying conference to incorporate the following criteria into the final keying schedule document:
1. Function of building, purpose of each area and degree of security required.
 2. Plans for future key system expansion.
 3. Requirements for key control storage and software.
 4. Installation of permanent keys, cylinder cores and software.
 5. Address and requirements for delivery of keys.
- H. Pre-Submittal Conference: Conduct coordination conference in compliance with requirements in Division 01 Section "Project Meetings" with attendance by representatives of Supplier(s), Installer(s), and Contractor(s) to review proper methods and the procedures for receiving, handling, and installing door hardware.
1. Prior to installation of door hardware, conduct a project specific training meeting to instruct the installing contractors' personnel on the proper installation and adjustment of their respective products. Product training to be attended by installers of door hardware (including electromechanical hardware) for aluminum, hollow metal and wood doors. Training will include the use of installation manuals, hardware schedules, templates and physical product samples as required.
 2. Inspect and discuss electrical roughing-in, power supply connections, and other preparatory work performed by other trades.
 3. Review sequence of operation narratives for each unique access controlled opening.
 4. Review and finalize construction schedule and verify availability of materials.
 5. Review the required inspecting, testing, commissioning, and demonstration procedures
- I. At completion of installation, provide written documentation that components were applied according to manufacturer's instructions and recommendations and according to approved schedule.

1.5 DELIVERY, STORAGE, AND HANDLING

- A. Inventory door hardware on receipt and provide secure lock-up and shelving for door hardware delivered to Project site. Do not store electronic access control hardware, software or accessories at Project site without prior authorization.
- B. Tag each item or package separately with identification related to the final Door Hardware Schedule, and include basic installation instructions with each item or package.
- C. Deliver, as applicable, permanent keys, cylinders, cores, access control credentials, software and related accessories directly to Owner via registered mail or overnight package service. Instructions for delivery to the Owner shall be established at the "Keying Conference".

1.6 COORDINATION

- A. Templates: Obtain and distribute to the parties involved templates for doors, frames, and other work specified to be factory prepared for installing standard and electrified hardware. Check Shop

Drawings of other work to confirm that adequate provisions are made for locating and installing hardware to comply with indicated requirements.

- B. Door and Frame Preparation: Doors and corresponding frames are to be prepared, reinforced and pre-wired (if applicable) to receive the installation of the specified electrified, monitoring, signaling and access control system hardware without additional in-field modifications.

1.7 WARRANTY

- A. General Warranty: Reference Division 01, General Requirements. Special warranties specified in this Article shall not deprive Owner of other rights Owner may have under other provisions of the Contract Documents and shall be in addition to, and run concurrent with, other warranties made by Contractor under requirements of the Contract Documents.
- B. Warranty Period: Written warranty, executed by manufacturer(s), agreeing to repair or replace components of standard and electrified door hardware that fails in materials or workmanship within specified warranty period after final acceptance by the Owner. Failures include, but are not limited to, the following:
 - 1. Structural failures including excessive deflection, cracking, or breakage.
 - 2. Faulty operation of the hardware.
 - 3. Deterioration of metals, metal finishes, and other materials beyond normal weathering.
 - 4. Electrical component defects and failures within the systems operation.
- C. Warranty Period: Unless otherwise indicated, warranty shall be one year from date of Substantial Completion.

PART 2 - PRODUCTS

2.1 SCHEDULED DOOR HARDWARE

- A. General: Provide door hardware for each door to comply with requirements in Door Hardware Sets and each referenced section that products are to be supplied under.
- B. Designations: Requirements for quantity, item, size, finish or color, grade, function, and other distinctive qualities of each type of door hardware are indicated in the Door Hardware Sets at the end of Part 3. Products are identified by using door hardware designations, as follows:
 - 1. Named Manufacturer's Products: Product designation and manufacturer are listed for each door hardware type required for the purpose of establishing requirements. Manufacturers' names are abbreviated in the Door Hardware Schedule.
- C. Please note that ASSA ABLOY is transitioning the Yale Commercial brand to Arrow. This affects only the brand name; the products and product numbers will remain unchanged. The brand transition is expected to be complete in or about May of 2024, and products shipping after that time will be branded Arrow.
- D. Substitutions: Requests for substitution and product approval for inclusive mechanical and electromechanical door hardware in compliance with the specifications must be submitted in writing and in accordance with the procedures and time frames outlined in Division 01, Substitution Procedures. Approval of requests is at the discretion of the architect, owner, and their designated consultants.

2.2 HANGING DEVICES

A. Hinges: ANSI/BHMA A156.1 butt hinges with number of hinge knuckles and other options as specified in the Door Hardware Sets.

1. Quantity: Provide the following hinge quantity:
 - a. Two Hinges: For doors with heights up to 60 inches.
 - b. Three Hinges: For doors with heights 61 to 90 inches.
 - c. Four Hinges: For doors with heights 91 to 120 inches.
 - d. For doors with heights more than 120 inches, provide 4 hinges, plus 1 hinge for every 30 inches of door height greater than 120 inches.
2. Hinge Size: Provide the following, unless otherwise indicated, with hinge widths sized for door thickness and clearances required:
 - a. Widths up to 3'0": 4-1/2" standard or heavy weight as specified.
 - b. Sizes from 3'1" to 4'0": 5" standard or heavy weight as specified.
3. Hinge Weight and Base Material: Unless otherwise indicated, provide the following:
 - a. Exterior Doors: Heavy weight, non-ferrous, ball bearing or oil impregnated bearing hinges unless Hardware Sets indicate standard weight.
 - b. Interior Doors: Standard weight, steel, ball bearing or oil impregnated bearing hinges unless Hardware Sets indicate heavy weight.
4. Hinge Options: Comply with the following:
 - a. Non-removable Pins: With the exception of electric through wire hinges, provide set screw in hinge barrel that, when tightened into a groove in hinge pin, prevents removal of pin while door is closed; for the all out-swinging lockable doors.
5. Manufacturers:
 - a. McKinney (MK) - TA/T4A Series, 5 knuckle.
 - b. Hager
 - c. Stanley

B. Continuous Geared Hinges: ANSI/BHMA A156.26 Grade 1-600 continuous geared hinge. with minimum 0.120-inch thick extruded 6063-T6 aluminum alloy hinge leaves and a minimum overall width of 4 inches. Hinges are non-handed, reversible and fabricated to template screw locations. Factory trim hinges to suit door height and prepare for electrical cut-outs.

1. Manufacturers:
 - a. Pemko (PE).

2.3 DOOR OPERATING TRIM

A. Flush Bolts and Surface Bolts: Provide products conforming to ANSI/BHMA A156.3 and A156.16, Grade 1.

1. Flush bolts to be furnished with top rod of sufficient length to allow bolt retraction device location approximately six feet from the floor.
2. Furnish dust proof strikes for bottom bolts.
3. Surface bolts to be minimum 8" in length and U.L. listed for labeled fire doors and U.L. listed for windstorm components where applicable.
4. Provide related accessories (mounting brackets, strikes, coordinators, etc.) as required for appropriate installation and operation.
5. Manufacturers:
 - a. Rockwood (RO).

B. Door Push Plates and Pulls: ANSI/BHMA A156.6 door pushes and pull units of type and design specified in the Hardware Sets. Coordinate and provide proper width and height as required where conflicting hardware dictates.

1. Push/Pull Plates: Minimum .050 inch thick, size as indicated in hardware sets, with beveled edges, secured with exposed screws unless otherwise indicated.
2. Door Pull and Push Bar Design: Size, shape, and material as indicated in the hardware sets. Minimum clearance of 2 1/2-inches from face of door unless otherwise indicated.
3. Offset Pull Design: Size, shape, and material as indicated in the hardware sets. Minimum clearance of 2 1/2-inches from face of door and offset of 90 degrees unless otherwise indicated.
4. Pulls, where applicable, shall be provided with a 10" clearance from the finished floor on the push side to accommodate wheelchair accessibility.
5. Fasteners: Provide manufacturer's designated fastener type as indicated in Hardware Sets.
6. Manufacturers:
 - a. Rockwood (RO).
 - b. Hiawatha
 - c. Quality
 - d. Ives
 - e. Burns

2.4 CYLINDERS AND KEYING

A. General: Cylinder manufacturer to have minimum (10) years experience designing secured master key systems and have on record a published security keying system policy.

1. Manufacturers:
 - a. BEST Interchangeable Core, SFIC (Small Format), 6-7 Pin, or equivalent.

B. Cylinder Types: Original manufacturer cylinders able to supply the following cylinder formats and types:

1. Threaded mortise cylinders with rings and cams to suit hardware application.
2. Rim cylinders with back plate, flat-type vertical or horizontal tailpiece, and raised trim ring.
3. Bored or cylindrical lock cylinders with tailpieces as required to suit locks.
4. Tubular deadlocks and other auxiliary locks.
5. Mortise and rim cylinder collars to be solid and recessed to allow the cylinder face to be flush and be free spinning with matching finishes.

6. Keyway: "Best" To be determined as directed by Owner.
- C. Keying System: Each type of lock and cylinders to be factory keyed.
1. Supplier shall conduct a "Keying Conference" to define and document keying system instructions and requirements.
 2. Furnish factory cut, nickel-silver large bow permanently inscribed with a visual key control number as directed by Owner.
- D. Key Quantity: Provide the following minimum number of keys:
1. Change Keys per Cylinder: Two (2)
 2. Master Keys (per Master Key Level/Group): Five (5).
 3. Construction Keys (where required): Ten (10).
- E. Construction Keying: Provide construction master keyed cylinders.
- F. Key Registration List (Bitting List):
1. Provide keying transcript list to Owner's representative in the proper format for importing into key control software.
 2. Provide transcript list in writing or electronic file as directed by the Owner.

2.5 KEY CONTROL

- A. Key Control Cabinet: Provide a key control system including envelopes, labels, and tags with self-locking key clips, receipt forms, 3-way visible card index, temporary markers, permanent markers, and standard metal cabinet. Key control cabinet shall have expansion capacity of 150% of the number of locks required for the project.
1. Manufacturers:
 - a. Lund Equipment (LU).
 - b. MMF Industries (MM).
 - c. Telkee (TK).

2.6 MECHANICAL LOCKS AND LATCHING DEVICES

- A. Mortise Locksets, Grade 1 (Heavy Duty): ANSI/BHMA A156.13, Series 1000, Operational Grade 1 Certified Products Directory (CPD) listed. Locksets are to be manufactured with a corrosion resistant steel case and be field-reversible for handing without disassembly of the lock body.
1. Heavy duty mortise locks shall have a ten-year warranty.
 2. Extended cycle test: Locks to have been cycle tested in ordinance with ANSI/BHMA 156.13 requirements to 12.3 million cycles or greater.
 3. Manufacturers:
 - a. Arrow, formerly known as Yale (YA) - 8800FL Series.
 - b. Corbin Russwin
 - c. Sargent

d. Schlage

2.7 LOCK AND LATCH STRIKES

- A. Strikes: Provide manufacturer's standard strike with strike box for each latch or lock bolt, with curved lip extended to protect frame, finished to match door hardware set, unless otherwise indicated, and as follows:
1. Flat-Lip Strikes: For locks with three-piece antifriction latchbolts, as recommended by manufacturer.
 2. Extra-Long-Lip Strikes: For locks used on frames with applied wood casing trim.
 3. Aluminum-Frame Strike Box: Provide manufacturer's special strike box fabricated for aluminum framing.
 4. Double-lipped strikes: For locks at double acting doors. Furnish with retractable stop for rescue hardware applications.
- B. Standards: Comply with the following:
1. Strikes for Mortise Locks and Latches: BHMA A156.13.
 2. Strikes for Bored Locks and Latches: BHMA A156.2.
 3. Strikes for Auxiliary Deadlocks: BHMA A156.36.
 4. Dustproof Strikes: BHMA A156.16.

2.8 CONVENTIONAL EXIT DEVICES

- A. General Requirements: All exit devices specified herein shall meet or exceed the following criteria:
1. Exit devices shall have a five-year warranty.
 2. At doors not requiring a fire rating, provide devices complying with NFPA 101 and listed and labeled for "Panic Hardware" according to UL305. Provide proper fasteners as required by manufacturer including sex nuts and bolts at openings specified in the Hardware Sets.
 3. Where exit devices are required on fire rated doors, provide devices complying with NFPA 80 and with UL labeling indicating "Fire Exit Hardware". Provide devices with the proper fasteners for installation as tested and listed by UL. Consult manufacturer's catalog and template book for specific requirements.
 4. Except on fire rated doors, provide exit devices with hex key dogging device to hold the pushbar and latch in a retracted position. Provide optional keyed cylinder dogging on devices where specified in Hardware Sets.
 5. Devices must fit flat against the door face with no gap that permits unauthorized dogging of the push bar. The addition of filler strips is required in any case where the door light extends behind the device as in a full glass configuration.
 6. Lever Operating Trim: Where exit devices require lever trim, furnish manufacturer's heavy duty escutcheon trim with threaded studs for thru-bolts.
 - a. Lock Trim Design: As indicated in Hardware Sets, provide finishes and designs to match that of the specified locksets.
 - b. Where function of exit device requires a cylinder, provide a cylinder (Rim or Mortise) as specified in Hardware Sets.

7. Vertical Rod Exit Devices: Where surface or concealed vertical rod exit devices are used at interior openings, provide as less bottom rod (LBR) unless otherwise indicated. Provide dust proof strikes where thermal pins are required to project into the floor.
 8. Narrow Stile Applications: At doors constructed with narrow stiles, or as specified in Hardware Sets, provide devices designed for maximum 2" wide stiles.
 9. Dummy Push Bar: Nonfunctioning push bar matching functional push bar.
 10. Rail Sizing: Provide exit device rails factory sized for proper door width application.
 11. Through Bolt Installation: For exit devices and trim as indicated in Door Hardware Sets.
- B. Tubular Panic Devices: ANSI/BHMA A156.3, Grade 1 Certified Products Directory (CPD) listed panic and fire exit hardware devices furnished in the functions specified in the Hardware Sets. Device to be ADA compliant requiring less than 5 lbs. of force to activate. Post mounting with optional mechanical dogging. Provide proper fasteners as required by manufacturer to meet application requirements. Provide exit devices on both leaves of pairs of doors.
1. Style: Exposed vertical rod. 1-1/4" grip diameter with interior operating panic handle in combination with exterior fixed pull handle. Panic mechanism shall be concealed within brass or stainless steel tubing. Optional entrance from exterior by a keyed cylinder.
 2. Configurations (provide as specified):
 - a. Half Height L-Shape Pull.
 3. Push/pull operation when dogged from the inside.
 4. Latching: Top latching. Reversed, flat, Pullman style. Roller-type latching not acceptable.
 5. Engraved "PUSH" signage with optional paint infill and boundary grooves.
 6. Manufacturers:
 - a. Rockwood (RO) - PDU8500 Series.
 - b. Corbin Russwin
 - c. Von Duprin
 - d. Sargent
 - e. Precision
 - f. Monarch

2.9 DOOR CLOSERS

- A. All door closers specified herein shall meet or exceed the following criteria:
1. General: Door closers to be from one manufacturer, matching in design and style, with the same type door preparations and templates regardless of application or spring size. Closers to be non-handed with full sized covers.
 2. Standards: Closers to comply with UL-10C for Positive Pressure Fire Test and be U.L. listed for use of fire rated doors.
 3. Size of Units: Comply with manufacturer's written recommendations for sizing of door closers depending on size of door, exposure to weather, and anticipated frequency of use. Where

closers are indicated for doors required to be accessible to the Americans with Disabilities Act, provide units complying with ANSI ICC/A117.1.

4. Closer Arms: Provide heavy duty, forged steel closer arms unless otherwise indicated in Hardware Sets.
5. Closers shall not be installed on exterior or corridor side of doors; where possible install closers on door for optimum aesthetics.
6. Closer Accessories: Provide door closer accessories including custom templates, special mounting brackets, spacers and drop plates as required for proper installation. Provide through-bolt and security type fasteners as specified in the hardware sets.

B. Door Closers, Surface Mounted (Heavy Duty): ANSI/BHMA A156.4, Grade 1 Certified Products Directory (CPD) listed surface mounted, heavy duty door closers with complete spring power adjustment, sizes 1 thru 6; and fully operational adjustable according to door size, frequency of use, and opening force. Closers to be rack and pinion type, one piece cast iron or aluminum alloy body construction, with adjustable backcheck and separate non-critical valves for closing sweep and latch speed control. Provide non-handed units standard.

1. Heavy duty surface mounted door closers shall have a 30-year warranty.
2. Manufacturers:
 - a. Arrow, formerly known as Yale (YA) - 4400 Series.
 - b. Corbin Russwin
 - c. LCN
 - d. Norton
 - e. Sargent

C. Door Closers, Surface Mounted (Unitrol): ANSI/BHMA A156.4, Grade 1 Certified Products Directory (CPD) listed surface mounted closers with door stop mechanism to absorb dead stop shock on arm and top hinge. Hold-open arms to have a spring loaded mechanism in addition to shock absorber assembly. Arms to be provided with rigid steel main arm and secondary arm lengths proportional to the door width.

1. Manufacturers:
 - a. Arrow, formerly known as Yale (YA) - Unitrol Series.

2.10 ARCHITECTURAL TRIM

A. Door Protective Trim

1. General: Door protective trim units to be of type and design as specified below or in the Hardware Sets.
2. Size: Fabricate protection plates (kick, armor, or mop) not more than 2" less than door width (LDW) on stop side of single doors and 1" LDW on stop side of pairs of doors, and not more than 1" less than door width on pull side. Coordinate and provide proper width and height as required where conflicting hardware dictates. Height to be as specified in the Hardware Sets.

3. Where plates are applied to fire rated doors with the top of the plate more than 16" above the bottom of the door, provide plates complying with NFPA 80. Consult manufacturer's catalog and template book for specific requirements for size and applications.
4. Protection Plates: ANSI/BHMA A156.6 protection plates (kick, armor, or mop), fabricated from the following:
 - a. Stainless Steel: 300 grade, 050-inch thick.
5. Options and fasteners: Provide manufacturer's designated fastener type as specified in the Hardware Sets. Provide countersunk screw holes.
6. Manufacturers:
 - a. Rockwood (RO).
 - b. Hiawatha
 - c. Quality
 - d. Ives
 - e. Burns

2.11 DOOR STOPS AND HOLDERS

- A. General: Door stops and holders to be of type and design as specified below or in the Hardware Sets.
- B. Door Stops and Bumpers: ANSI/BHMA A156.16, Grade 1 door stops and wall bumpers. Provide wall bumpers, either convex or concave types with anchorage as indicated, unless floor or other types of door stops are specified in Hardware Sets. Do not mount floor stops where they will impede traffic. Where floor or wall bumpers are not appropriate, provide overhead type stops and holders.
 1. Manufacturers:
 - a. Rockwood (RO).

2.12 ARCHITECTURAL SEALS

- A. General: Thresholds, weatherstripping, and gasket seals to be of type and design as specified below or in the Hardware Sets. Provide continuous weatherstrip gasketing on exterior doors and provide smoke, light, or sound gasketing on interior doors where indicated. At exterior applications provide non-corrosive fasteners and elsewhere where indicated.
- B. Smoke Labeled Gasketing: Assemblies complying with NFPA 105 that are listed and labeled by a testing and inspecting agency acceptable to authorities having jurisdiction, for smoke control ratings indicated, based on testing according to UL 1784.
 1. Provide smoke labeled perimeter gasketing at all smoke labeled openings.
- C. Fire Labeled Gasketing: Assemblies complying with NFPA 80 that are listed and labeled by a testing and inspecting agency acceptable to authorities having jurisdiction, for fire ratings indicated, based on testing according to UL-10C.

1. Provide intumescent seals as indicated to meet UL10C Standard for Positive Pressure Fire Tests of Door Assemblies, and NPFA 252, Standard Methods of Fire Tests of Door Assemblies.
- D. Sound-Rated Gasketing: Assemblies that are listed and labeled by a testing and inspecting agency, for sound ratings indicated.
- E. Replaceable Seal Strips: Provide only those units where resilient or flexible seal strips are easily replaceable and readily available from stocks maintained by manufacturer.
- F. Manufacturers:
 1. Pemko (PE).
 2. Zero
 3. Reese
 4. National Guard

2.13 FABRICATION

- A. Fasteners: Provide door hardware manufactured to comply with published templates generally prepared for machine, wood, and sheet metal screws. Provide screws according to manufacturers recognized installation standards for application intended.

2.14 FINISHES

- A. Standard: Designations used in the Hardware Sets and elsewhere indicate hardware finishes complying with ANSI/BHMA A156.18, including coordination with traditional U.S. finishes indicated by certain manufacturers for their products.
- B. Provide quality of finish, including thickness of plating or coating (if any), composition, hardness, and other qualities complying with manufacturer's standards, but in no case less than specified by referenced standards for the applicable units of hardware
- C. Protect mechanical finishes on exposed surfaces from damage by applying a strippable, temporary protective covering before shipping.

PART 3 - EXECUTION

3.1 EXAMINATION

- A. Examine scheduled openings, with Installer present, for compliance with requirements for installation tolerances, labeled fire door assembly construction, wall and floor construction, and other conditions affecting performance.
- B. Notify architect of any discrepancies or conflicts between the door schedule, door types, drawings and scheduled hardware. Proceed only after such discrepancies or conflicts have been resolved in writing.

3.2 PREPARATION

- A. Hollow Metal Doors and Frames: Comply with ANSI/DHI A115 series.
- B. Wood Doors: Comply with ANSI/DHI A115-W series.

3.3 INSTALLATION

- A. Install each item of mechanical and electromechanical hardware and access control equipment to comply with manufacturer's written instructions and according to specifications.
 - 1. Installers are to be trained and certified by the manufacturer on the proper installation and adjustment of fire, life safety, and security products including: hanging devices; locking devices; closing devices; and seals.
- B. Mounting Heights: Mount door hardware units at heights indicated in following applicable publications, unless specifically indicated or required to comply with governing regulations:
 - 1. Standard Steel Doors and Frames: DHI's "Recommended Locations for Architectural Hardware for Standard Steel Doors and Frames."
 - 2. DHI TDH-007-20: Installation Guide for Doors and Hardware.
 - 3. Where indicated to comply with accessibility requirements, comply with ANSI A117.1 "Accessibility Guidelines for Buildings and Facilities."
 - 4. Provide blocking in drywall partitions where wall stops or other wall mounted hardware is located.
- C. Retrofitting: Install door hardware to comply with manufacturer's published templates and written instructions. Where cutting and fitting are required to install door hardware onto or into surfaces that are later to be painted or finished in another way, coordinate removal, storage, and reinstallation of surface protective trim units with finishing work specified in Division 9 Sections. Do not install surface-mounted items until finishes have been completed on substrates involved.
- D. Thresholds: Set thresholds for exterior and acoustical doors in full bed of sealant complying with requirements specified in Division 7 Section "Joint Sealants."
- E. Storage: Provide a secure lock up for hardware delivered to the project but not yet installed. Control the handling and installation of hardware items so that the completion of the work will not be delayed by hardware losses before and after installation.

3.4 ADJUSTING

- A. Initial Adjustment: Adjust and check each operating item of door hardware and each door to ensure proper operation or function of every unit. Replace units that cannot be adjusted to operate as intended. Adjust door control devices to compensate for final operation of heating and ventilating equipment and to comply with referenced accessibility requirements.

3.5 CLEANING AND PROTECTION

- A. Protect all hardware stored on construction site in a covered and dry place. Protect exposed hardware installed on doors during the construction phase. Install any and all hardware at the latest possible time frame.

- B. Clean adjacent surfaces soiled by door hardware installation.
- C. Clean operating items as necessary to restore proper finish. Provide final protection and maintain conditions that ensure door hardware is without damage or deterioration at time of owner occupancy.

3.6 DEMONSTRATION

- A. Instruct Owner's maintenance personnel to adjust, operate, and maintain mechanical and electromechanical door hardware.

3.7 DOOR HARDWARE SETS

- A. The hardware sets represent the design intent and direction of the owner and architect. They are a guideline only and should not be considered a detailed hardware schedule. Discrepancies, conflicting hardware and missing items should be brought to the attention of the architect with corrections made prior to the bidding process. Omitted items not included in a hardware set should be scheduled with the appropriate additional hardware required for proper application and functionality.

1. Quantities listed are for each pair of doors, or for each single door.
2. The supplier is responsible for handing and sizing all products.
3. Where multiple options for a piece of hardware are given in a single line item, the supplier shall provide the appropriate application for the opening.

- B. Manufacturer's Abbreviations:

1. MK - McKinney
2. PE - Pemko
3. RO - Rockwood
4. YA - Arrow, formerly known as Yale
6. OT - Other

Hardware Sets

Set: 1.0

Doors: 101A, 103A

2	Continuous Hinge	CFM_SLF-HD1 x Length Required	PE	087100
2	Storefront Panic Device	PDU8500-1 01 (Keyed as Required)	US32D RO	087100
2	Drop Plate	486	689 YA	087100
2	Blade Stop	891	689 YA	087100
2	Surface Closer	UNI4400 (HD PA SPG STP Arm - EXT)	689 YA	087100

1	Threshold	273x224AFGT x MSES25SS x Length Required	PE	087100
1	Gasketing	Provided By Door/Frame Supplier	OT	
2	Sweep	3452CNB x Length Required	PE	087100

Notes: Perimeter Weatherstrip by the Aluminum Door Manufacturer.

Set: 2.0

Doors: 111A

6	Hinge, Full Mortise, Hvy Wt	T4A3386 (NRP and size as required)	US32D	MK	087100
1	Self Latching Flush Bolt Set	2845 / 2945 (as required)	US26D	RO	087100
1	Dust Proof Strike	570	US26D	RO	087100
1	Storeroom or Closet Lock	TBR 8805RL (Keyed as Required)	630	YA	087100
2	Surface Closer	UNI4410 (HD PA SPG STP Arm w/HO - EXT)	689	YA	087100
2	Kick Plate	K1050 10" high CSK BEV	US32D	RO	087100
1	Threshold	175A MSES25SS x Length Required		PE	087100
1	Gasketing	303AS (Head & Jambs)		PE	087100
1	Rain Guard	346C x Width of Frame Head		PE	087100
2	Sweep	3452CNB x Length Required		PE	087100
2	Astragal	29324CNB x Door Height		PE	087100

Set: 2.1

Doors: 110A

3	Hinge, Full Mortise, Hvy Wt	T4A3386 (NRP and size as required)	US32D	MK	087100
1	Storeroom or Closet Lock	TBR 8805RL (Keyed as Required)	630	YA	087100
1	Surface Closer	UNI4400 (HD PA SPG STP Arm - EXT)	689	YA	087100
1	Electric Strike	1600-CS	630	HS	087100
1	ElectroLynx Adaptor	2004M		HS	087100
1	SMART Pac Bridge Rectifier	2005M3		HS	087100
1	Kick Plate	K1050 10" high CSK BEV	US32D	RO	087100
1	Threshold	175A MSES25SS x Length Required		PE	087100
1	Gasketing	303AS (Head & Jambs)		PE	087100
1	Rain Guard	346C x Width of Frame Head		PE	087100
1	Sweep	3452CNB x Length Required		PE	087100
1	Card Reader	By Security Supplier			
1	ElectroLynx Harness (Frame)	QC-C3000P		MK	087100
1	Position Switch	DPS-MW-BK/GY/WH (as required)		SU	087100

1 Motion Sensor	XMS		SU	087100
1 Power Supply	AQD (Size and Options as required)		SU	087100
1 Wiring Diagram	Elevation and Point to Point as Specified		OT	

Notes: This opening is scheduled and is to be wired for future access control operation. Coordinate all Wiring and conduit with electrical contractor.

Intended Future Operation Description:

- The door is normally closed and secure.
- When a proper credential is presented to the Card Reader (by Others) the power supply will momentarily release the electric strike to allow entry.
- Egress from the unsecured side is always available by turning the lever on the lockset. Request to Exit Sensor on the unsecure side of the opening will signal and authorized egress to access control.
- Door Position Switch will monitor the doors OPEN/CLOSED status.
- Key on secured side will retract latch to allow entry.
- Electric Strike is Fail Secure and will remain locked in the event of a fire emergency or power outage.

Set: 3.0

NOT USED

3 Hinge, Full Mortise, Hvy Wt	T4A3386 (NRP and size as required)	US32D	MK	087100
4 Storeroom or Closet Lock	TBR 8805RL (Keyed as Required)	630	YA	087100
4 Surface Closer	UNI4400 (HD PA SPG STP Arm-EXT)	689	YA	087100
4 Kick Plate	K1050 10" high CSK BEV	US32D	RO	087100
4 Threshold	175A MSES25SS x Length Required		PE	087100
4 Gasketing	303AS (Head & Jambs)		PE	087100
4 Rain Guard	346C x Width of Frame Head		PE	087100
4 Sweep	3452CNB x Length Required		PE	087100

Set: 4.0

Doors: 101B, 103B

2 Continuous Hinge	CFM_SLF-HD1 x Length Required		PE	087100
2 Door Pull	RM3301 (Full Door Height - HD Back-to-Back Mounting)	US32D	RO	087100
2 Drop Plate	486	689	YA	087100
2 Blade Stop	891	689	YA	087100
2 Surface Closer	4420 (HD PA SPG STP Arm)	689	YA	087100
1 Gasketing	Provided By Door/Frame Supplier		OT	

Notes: Perimeter Weatherstrip and astragals by the Aluminum Door Manufacturer.

Set: 5.0

Doors: 001, 111B

3 Hinge, Full Mortise	TA2714 (NRP and size as required)	US26D	MK	087100
1 Storeroom or Closet Lock	TBR 8805RL (Keyed as Required)	630	YA	087100
1 Surface Closer (Tri-Pack)	4400 (RA or PA Mount as Required)	689	YA	087100
1 Kick Plate	K1050 10" high CSK BEV	US32D	RO	087100
1 Wall Stop	403 (or) 441CU (As Required)	US26D	RO	087100
3 Silencer	608		RO	087100

Set: 5.1

Doors: 110B

3 Hinge, Full Mortise, Hvy Wt	T4A3786 (NRP and size as required)	US26D	MK	087100
1 Storeroom or Closet Lock	TBR 8805RL (Keyed as Required)	630	YA	087100
1 Surface Closer (Tri-Pack)	4400 (RA or PA Mount as Required)	689	YA	087100
1 Electric Strike	1600-CS	630	HS	087100
1 ElectroLynx Adaptor	2004M		HS	087100
1 SMART Pac Bridge Rectifier	2005M3		HS	087100
1 Kick Plate	K1050 10" high CSK BEV	US32D	RO	087100
1 Wall Stop	403 (or) 441CU (As Required)	US26D	RO	087100
3 Silencer	608		RO	087100
1 Card Reader	By Security Supplier			
1 ElectroLynx Harness (Frame)	QC-C3000P		MK	087100
1 Position Switch	DPS-MW-BK/GY/WH (as required)		SU	087100
1 Motion Sensor	XMS		SU	087100
1 Power Supply	AQD (Size and Options as required)		SU	087100
1 Wiring Diagram	Elevation and Point to Point as Specified		OT	

Notes: This opening is scheduled and is to be wired for future access control operation. Coordinate all Wiring and conduit with electrical contractor.

Intended Future Operation Description:

- The door is normally closed and secure.
- When a proper credential is presented to the Card Reader (by Others) the power supply will momentarily release the electric strike to allow entry.
- Egress from the unsecured side is always available by turning the lever on the lockset. Request to Exit Sensor on the unsecure side of the opening will signal and authorized egress to access control.

- Door Position Switch will monitor the doors OPEN/CLOSED status.
- Key on secured side will retract latch to allow entry.
- Electric Strike is Fail Secure and will remain locked in the event of a fire emergency or power outage.

Set: 6.0

NOT USED

3 Hinge, Full Mortise	TA2714 (NRP and size as required)	US26D	MK	087100
1 Storeroom or Closet Lock	TBR 8805RL (Keyed as Required)	630	YA	087100
1 Surface Closer	4420 (HD PA SPG STP Arm)	689	YA	087100
1 Kick Plate	K1050 10" high CSK BEV	US32D	RO	087100
3 Silencer	608		RO	087100

Set: 6.1

Doors: 115

3 Hinge, Full Mortise, Hvy Wt	T4A3786 (NRP and size as required)	US26D	MK	087100
1 Rim Exit Device, Nightlatch	7150 TB627F (Keyed as Required)	630	YA	087100
1 Surface Closer	4420 (HD PA SPG STP Arm)	689	YA	087100
1 Kick Plate	K1050 10" high CSK BEV	US32D	RO	087100
3 Silencer	608		RO	087100

Set: 7.0

Doors: 113B, 114

3 Hinge, Full Mortise	TA2714 (NRP and size as required)	US26D	MK	087100
1 Office Lock	TBR 8807RL (Keyed as Required)	630	YA	087100
1 Wall Stop	403 (or) 441CU (As Required)	US26D	RO	087100
1 Silencer	608		RO	087100

Set: 8.0

Doors: 104, 105, 112

3 Hinge, Full Mortise	TA2714 (NRP and size as required)	US26D	MK	087100
1 Privacy Lock (w/OCC IND)	TBR 8802RL V21	630	YA	087100
1 Surface Closer (Tri-Pack)	4400 (RA or PA Mount as Required)	689	YA	087100
1 Kick Plate	K1050 10" high CSK BEV	US32D	RO	087100
1 Wall Stop	403 (or) 441CU (As Required)	US26D	RO	087100

3	Silencer	608		RO	087100
1	Coat Hook	RM801	US26D	RO	087100

Set: 9.0

Doors: 106A, 107A, 108A, 109A

3	Hinge, Full Mortise, Hvy Wt	T4A3786 (NRP and size as required)	US26D	MK	087100
1	Mortise Deadlock (Double Key/Classroom)	356 (Key as Required)	630	YA	087100
1	Push Plate	70C-RKW	US32D	RO	087100
1	Pull	RM3020-12 Mtg-Type 12XHD	US32-316	RO	087100
1	Surface Closer (Tri-Pack)	4400 (RA or PA Mount as Required)	689	YA	087100
1	Kick Plate	K1050 10" high CSK BEV	US32D	RO	087100
1	Wall Stop	403 (or) 441CU (As Required)	US26D	RO	087100
1	Silencer	608		RO	087100

Notes: Door can be locked into alternate jamb when opened 90 degrees. (Two Deadbolt Strikes are required)

END OF SECTION

Remove and replace Section 08 71 00.20 - Door Hardware – (Maintenance Building) with the following:

Section 08 71 00.20 - Door Hardware – (Maintenance Building)

PART 1 - GENERAL

1.1 RELATED DOCUMENTS

- A. Drawings and general provisions of the Contract, including General and Supplementary Conditions and Division 1 Specification Sections, apply to this Section.

1.2 SUMMARY

- A. This Section includes commercial door hardware for the following:
 - 1. Swinging doors.
- B. Door hardware includes, but is not necessarily limited to, the following:
 - 1. Mechanical door hardware.
 - 2. Cylinders specified for doors in other sections.

C. Related Sections:

1. Division 08 Section "Hollow Metal Doors and Frames".
2. Division 08 Section "Aluminum-Framed Entrances and Storefronts".

D. Codes and References: Comply with the version year adopted by the Authority Having Jurisdiction.

1. ANSI A117.1 - Accessible and Usable Buildings and Facilities.
2. ICC/IBC - International Building Code.
3. NFPA 70 - National Electrical Code.
4. NFPA 80 - Fire Doors and Windows.
5. NFPA 101 - Life Safety Code.
6. NFPA 105 - Installation of Smoke Door Assemblies.
7. State Building Codes, Local Amendments.

E. Standards: All hardware specified herein shall comply with the following industry standards as applicable. Any undated reference to a standard shall be interpreted as referring to the latest edition of that standard:

1. ANSI/BHMA Certified Product Standards - A156 Series.
2. UL10C - Positive Pressure Fire Tests of Door Assemblies.
3. ANSI/UL 294 - Access Control System Units.
4. UL 305 - Panic Hardware.
5. ANSI/UL 437- Key Locks.

1.3 SUBMITTALS

A. Product Data: Manufacturer's product data sheets including installation details, material descriptions, dimensions of individual components and profiles, operational descriptions and finishes.

B. Door Hardware Schedule: Prepared by or under the supervision of supplier, detailing, fabrication and assembly of door hardware, as well as procedures and diagrams. Coordinate the final Door Hardware Schedule with doors, frames, and related work to ensure proper size, thickness, hand, function, and finish of door hardware.

1. Format: Comply with scheduling sequence and vertical format in DHI's "Sequence and Format for the Hardware Schedule."
2. Organization: Organize the Door Hardware Schedule into door hardware sets indicating complete designations of every item required for each door or opening. Organize door hardware sets in same order as in the Door Hardware Sets at the end of Part 3. Submittals that do not follow the same format and order as the Door Hardware Sets will be rejected and subject to resubmission.
3. Content: Include the following information:
 - a. Type, style, function, size, label, hand, and finish of each door hardware item.
 - b. Manufacturer of each item.
 - c. Fastenings and other pertinent information.
 - d. Location of door hardware set, cross-referenced to Drawings, both on floor plans and in door and frame schedule.
 - e. Explanation of abbreviations, symbols, and codes contained in schedule.
 - f. Mounting locations for door hardware.

- g. Door and frame sizes and materials.
 - h. Warranty information for each product.
- 4. Submittal Sequence: Submit the final Door Hardware Schedule at earliest possible date, particularly where approval of the Door Hardware Schedule must precede fabrication of other work that is critical in the Project construction schedule. Include Product Data, Samples, Shop Drawings of other work affected by door hardware, and other information essential to the coordinated review of the Door Hardware Schedule.
- C. Keying Schedule: After a keying meeting with the owner has taken place prepare a separate keying schedule detailing final instructions. Submit the keying schedule in electronic format. Include keying system explanation, door numbers, key set symbols, hardware set numbers and special instructions. Owner must approve submitted keying schedule prior to the ordering of permanent cylinders/cores.
- D. Informational Submittals:
 - 1. Product Test Reports: Indicating compliance with cycle testing requirements, based on evaluation of comprehensive tests performed by manufacturer and witnessed by a qualified independent testing agency.
- E. Operating and Maintenance Manuals: Provide manufacturers operating and maintenance manuals for each item comprising the complete door hardware installation in quantity as required in Division 01, Closeout Procedures.

1.4 QUALITY ASSURANCE

- A. Manufacturers Qualifications: Engage qualified manufacturers with a minimum 5 years of documented experience in producing hardware and equipment similar to that indicated for this Project and that have a proven record of successful in-service performance.
- B. Certified Products: Where specified, products must maintain a current listing in the Builders Hardware Manufacturers Association (BHMA) Certified Products Directory (CPD).
- C. Installer Qualifications: A minimum 3 years documented experience installing both standard and electrified door hardware similar in material, design, and extent to that indicated for this Project and whose work has resulted in construction with a record of successful in-service performance.
- D. Door Hardware Supplier Qualifications: Experienced commercial door hardware distributors with a minimum 5 years documented experience supplying both mechanical and electromechanical hardware installations comparable in material, design, and extent to that indicated for this Project. Supplier recognized as a factory direct distributor by the manufacturers of the primary materials with a warehousing facility in Project's vicinity. Supplier to have on staff a certified Architectural Hardware Consultant (AHC) available during the course of the Work to consult with Contractor, Architect, and Owner concerning both standard and electromechanical door hardware and keying.
- E. Source Limitations: Obtain each type and variety of door hardware specified in this section from a single source unless otherwise indicated.
 - 1. Electrified modifications or enhancements made to a source manufacturer's product line by a secondary or third party source will not be accepted.
- F. Each unit to bear third party permanent label indicating compliance with the referenced testing standards.

- G. Keying Conference: Conduct conference to comply with requirements in Division 01 Section "Project Meetings." Keying conference to incorporate the following criteria into the final keying schedule document:
1. Function of building, purpose of each area and degree of security required.
 2. Plans for future key system expansion.
 3. Requirements for key control storage and software.
 4. Installation of permanent keys, cylinder cores and software.
 5. Address and requirements for delivery of keys.
- H. Pre-Submittal Conference: Conduct coordination conference in compliance with requirements in Division 01 Section "Project Meetings" with attendance by representatives of Supplier(s), Installer(s), and Contractor(s) to review proper methods and the procedures for receiving, handling, and installing door hardware.
1. Prior to installation of door hardware, conduct a project specific training meeting to instruct the installing contractors' personnel on the proper installation and adjustment of their respective products. Product training to be attended by installers of door hardware (including electromechanical hardware) for aluminum, hollow metal and wood doors. Training will include the use of installation manuals, hardware schedules, templates and physical product samples as required.
 2. Inspect and discuss electrical roughing-in, power supply connections, and other preparatory work performed by other trades.
 3. Review sequence of operation narratives for each unique access controlled opening.
 4. Review and finalize construction schedule and verify availability of materials.
 5. Review the required inspecting, testing, commissioning, and demonstration procedures
- I. At completion of installation, provide written documentation that components were applied according to manufacturer's instructions and recommendations and according to approved schedule.

1.5 DELIVERY, STORAGE, AND HANDLING

- A. Inventory door hardware on receipt and provide secure lock-up and shelving for door hardware delivered to Project site. Do not store electronic access control hardware, software or accessories at Project site without prior authorization.
- B. Tag each item or package separately with identification related to the final Door Hardware Schedule, and include basic installation instructions with each item or package.
- C. Deliver, as applicable, permanent keys, cylinders, cores, access control credentials, software and related accessories directly to Owner via registered mail or overnight package service. Instructions for delivery to the Owner shall be established at the "Keying Conference".

1.6 COORDINATION

- A. Templates: Obtain and distribute to the parties involved templates for doors, frames, and other work specified to be factory prepared for installing standard and electrified hardware. Check Shop Drawings of other work to confirm that adequate provisions are made for locating and installing hardware to comply with indicated requirements.
- B. Door and Frame Preparation: Doors and corresponding frames are to be prepared, reinforced and pre-wired (if applicable) to receive the installation of the specified electrified, monitoring, signaling and access control system hardware without additional in-field modifications.

1.7 WARRANTY

- A. General Warranty: Reference Division 01, General Requirements. Special warranties specified in this Article shall not deprive Owner of other rights Owner may have under other provisions of the Contract Documents and shall be in addition to, and run concurrent with, other warranties made by Contractor under requirements of the Contract Documents.
- B. Warranty Period: Written warranty, executed by manufacturer(s), agreeing to repair or replace components of standard and electrified door hardware that fails in materials or workmanship within specified warranty period after final acceptance by the Owner. Failures include, but are not limited to, the following:
 - 1. Structural failures including excessive deflection, cracking, or breakage.
 - 2. Faulty operation of the hardware.
 - 3. Deterioration of metals, metal finishes, and other materials beyond normal weathering.
 - 4. Electrical component defects and failures within the systems operation.
- C. Warranty Period: Unless otherwise indicated, warranty shall be one year from date of Substantial Completion.

PART 2 - PRODUCTS

2.1 SCHEDULED DOOR HARDWARE

- A. General: Provide door hardware for each door to comply with requirements in Door Hardware Sets and each referenced section that products are to be supplied under.
- B. Designations: Requirements for quantity, item, size, finish or color, grade, function, and other distinctive qualities of each type of door hardware are indicated in the Door Hardware Sets at the end of Part 3. Products are identified by using door hardware designations, as follows:
 - 1. Named Manufacturer's Products: Product designation and manufacturer are listed for each door hardware type required for the purpose of establishing requirements. Manufacturers' names are abbreviated in the Door Hardware Schedule.
- C. Please note that ASSA ABLOY is transitioning the Yale Commercial brand to Arrow. This affects only the brand name; the products and product numbers will remain unchanged. The brand transition is expected to be complete in or about May of 2024, and products shipping after that time will be branded Arrow.
- D. Substitutions: Requests for substitution and product approval for inclusive mechanical and electromechanical door hardware in compliance with the specifications must be submitted in writing and in accordance with the procedures and time frames outlined in Division 01, Substitution Procedures. Approval of requests is at the discretion of the architect, owner, and their designated consultants.

2.2 HANGING DEVICES

- A. Hinges: ANSI/BHMA A156.1 butt hinges with number of hinge knuckles and other options as specified in the Door Hardware Sets.

1. Quantity: Provide the following hinge quantity:
 - a. Two Hinges: For doors with heights up to 60 inches.
 - b. Three Hinges: For doors with heights 61 to 90 inches.
 - c. Four Hinges: For doors with heights 91 to 120 inches.
 - d. For doors with heights more than 120 inches, provide 4 hinges, plus 1 hinge for every 30 inches of door height greater than 120 inches.
 2. Hinge Size: Provide the following, unless otherwise indicated, with hinge widths sized for door thickness and clearances required:
 - a. Widths up to 3'0": 4-1/2" standard or heavy weight as specified.
 - b. Sizes from 3'1" to 4'0": 5" standard or heavy weight as specified.
 3. Hinge Weight and Base Material: Unless otherwise indicated, provide the following:
 - a. Exterior Doors: Heavy weight, non-ferrous, ball bearing or oil impregnated bearing hinges unless Hardware Sets indicate standard weight.
 - b. Interior Doors: Standard weight, steel, ball bearing or oil impregnated bearing hinges unless Hardware Sets indicate heavy weight.
 4. Hinge Options: Comply with the following:
 - a. Non-removable Pins: With the exception of electric through wire hinges, provide set screw in hinge barrel that, when tightened into a groove in hinge pin, prevents removal of pin while door is closed; for the all out-swinging lockable doors.
 5. Manufacturers:
 - a. McKinney (MK) - TA/T4A Series, 5 knuckle.
 - b. Hager
 - c. Stanley
- B. Continuous Geared Hinges: ANSI/BHMA A156.26 Grade 1-600 continuous geared hinge. with minimum 0.120-inch thick extruded 6063-T6 aluminum alloy hinge leaves and a minimum overall width of 4 inches. Hinges are non-handed, reversible and fabricated to template screw locations. Factory trim hinges to suit door height and prepare for electrical cut-outs.
1. Manufacturers:
 - a. Pemko (PE).

2.3 CYLINDERS AND KEYING

- A. General: Cylinder manufacturer to have minimum (10) years experience designing secured master key systems and have on record a published security keying system policy.
 1. Manufacturers:
 - a. BEST Interchangeable Core, SFIC (Small Format), 6-7 Pin, or equivalent
- B. Cylinder Types: Original manufacturer cylinders able to supply the following cylinder formats and types:

1. Threaded mortise cylinders with rings and cams to suit hardware application.
2. Rim cylinders with back plate, flat-type vertical or horizontal tailpiece, and raised trim ring.
3. Bored or cylindrical lock cylinders with tailpieces as required to suit locks.
4. Tubular deadlocks and other auxiliary locks.
5. Mortise and rim cylinder collars to be solid and recessed to allow the cylinder face to be flush and be free spinning with matching finishes.
6. Keyway: "Best" To be determined as directed by Owner.

C. Keying System: Each type of lock and cylinders to be factory keyed.

1. Supplier shall conduct a "Keying Conference" to define and document keying system instructions and requirements.
2. Furnish factory cut, nickel-silver large bow permanently inscribed with a visual key control number as directed by Owner.

D. Key Quantity: Provide the following minimum number of keys:

1. Change Keys per Cylinder: Two (2)
2. Master Keys (per Master Key Level/Group): Five (5).
3. Construction Keys (where required): Ten (10).

E. Construction Keying: Provide construction master keyed cylinders.

F. Key Registration List (Bitting List):

1. Provide keying transcript list to Owner's representative in the proper format for importing into key control software.
2. Provide transcript list in writing or electronic file as directed by the Owner.

2.4 MECHANICAL LOCKS AND LATCHING DEVICES

A. Mortise Locksets, Grade 1 (Heavy Duty): ANSI/BHMA A156.13, Series 1000, Operational Grade 1 Certified Products Directory (CPD) listed. Locksets are to be manufactured with a corrosion resistant steel case and be field-reversible for handing without disassembly of the lock body.

1. Heavy duty mortise locks shall have a ten-year warranty.
2. Extended cycle test: Locks to have been cycle tested in ordinance with ANSI/BHMA 156.13 requirements to 12.3 million cycles or greater.
3. Manufacturers:
 - a. Arrow, formerly known as Yale (YA) - 8800FL Series.
 - b. Corbin Russwin
 - c. Sargent
 - d. Schlage

2.5 LOCK AND LATCH STRIKES

A. Strikes: Provide manufacturer's standard strike with strike box for each latch or lock bolt, with curved lip extended to protect frame, finished to match door hardware set, unless otherwise indicated, and as follows:

1. Flat-Lip Strikes: For locks with three-piece antifriction latchbolts, as recommended by manufacturer.
2. Extra-Long-Lip Strikes: For locks used on frames with applied wood casing trim.
3. Aluminum-Frame Strike Box: Provide manufacturer's special strike box fabricated for aluminum framing.
4. Double-lipped strikes: For locks at double acting doors. Furnish with retractable stop for rescue hardware applications.

B. Standards: Comply with the following:

1. Strikes for Mortise Locks and Latches: BHMA A156.13.
2. Strikes for Bored Locks and Latches: BHMA A156.2.
3. Strikes for Auxiliary Deadlocks: BHMA A156.36.
4. Dustproof Strikes: BHMA A156.16.

2.6 DOOR CLOSERS

A. All door closers specified herein shall meet or exceed the following criteria:

1. General: Door closers to be from one manufacturer, matching in design and style, with the same type door preparations and templates regardless of application or spring size. Closers to be non-handed with full sized covers.
2. Standards: Closers to comply with UL-10C for Positive Pressure Fire Test and be U.L. listed for use of fire rated doors.
3. Size of Units: Comply with manufacturer's written recommendations for sizing of door closers depending on size of door, exposure to weather, and anticipated frequency of use. Where closers are indicated for doors required to be accessible to the Americans with Disabilities Act, provide units complying with ANSI ICC/A117.1.
4. Closer Arms: Provide heavy duty, forged steel closer arms unless otherwise indicated in Hardware Sets.
5. Closers shall not be installed on exterior or corridor side of doors; where possible install closers on door for optimum aesthetics.
6. Closer Accessories: Provide door closer accessories including custom templates, special mounting brackets, spacers and drop plates as required for proper installation. Provide through-bolt and security type fasteners as specified in the hardware sets.

B. Door Closers, Surface Mounted (Heavy Duty): ANSI/BHMA A156.4, Grade 1 Certified Products Directory (CPD) listed surface mounted, heavy duty door closers with complete spring power adjustment, sizes 1 thru 6; and fully operational adjustable according to door size, frequency of use, and opening force. Closers to be rack and pinion type, one piece cast iron or aluminum alloy body construction, with adjustable backcheck and separate non-critical valves for closing sweep and latch speed control. Provide non-handed units standard.

1. Heavy duty surface mounted door closers shall have a 30-year warranty.
2. Manufacturers:
 - a. Arrow, formerly known as Yale (YA) - 4400 Series.
 - b. Corbin Russwin

- c. LCN
- d. Norton
- e. Sargent

C. Door Closers, Surface Mounted (Unitrol): ANSI/BHMA A156.4, Grade 1 Certified Products Directory (CPD) listed surface mounted closers with door stop mechanism to absorb dead stop shock on arm and top hinge. Hold-open arms to have a spring loaded mechanism in addition to shock absorber assembly. Arms to be provided with rigid steel main arm and secondary arm lengths proportional to the door width.

- 1. Manufacturers:
 - a. Arrow, formerly known as Yale (YA) - Unitrol Series.

2.7 ARCHITECTURAL TRIM

A. Door Protective Trim

- 1. General: Door protective trim units to be of type and design as specified below or in the Hardware Sets.
- 2. Size: Fabricate protection plates (kick, armor, or mop) not more than 2" less than door width (LDW) on stop side of single doors and 1" LDW on stop side of pairs of doors, and not more than 1" less than door width on pull side. Coordinate and provide proper width and height as required where conflicting hardware dictates. Height to be as specified in the Hardware Sets.
- 3. Where plates are applied to fire rated doors with the top of the plate more than 16" above the bottom of the door, provide plates complying with NFPA 80. Consult manufacturer's catalog and template book for specific requirements for size and applications.
- 4. Protection Plates: ANSI/BHMA A156.6 protection plates (kick, armor, or mop), fabricated from the following:
 - a. Stainless Steel: 300 grade, 050-inch thick.
- 5. Options and fasteners: Provide manufacturer's designated fastener type as specified in the Hardware Sets. Provide countersunk screw holes.
- 6. Manufacturers:
 - a. Rockwood (RO).
 - b. Hiawatha
 - c. Quality
 - d. Ives
 - e. Burns

2.8 DOOR STOPS AND HOLDERS

A. General: Door stops and holders to be of type and design as specified below or in the Hardware Sets.

- B. Door Stops and Bumpers: ANSI/BHMA A156.16, Grade 1 door stops and wall bumpers. Provide wall bumpers, either convex or concave types with anchorage as indicated, unless floor or other types of door stops are specified in Hardware Sets. Do not mount floor stops where they will impede traffic. Where floor or wall bumpers are not appropriate, provide overhead type stops and holders.
 - 1. Manufacturers:
 - a. Rockwood (RO).

2.9 ARCHITECTURAL SEALS

- A. General: Thresholds, weatherstripping, and gasket seals to be of type and design as specified below or in the Hardware Sets. Provide continuous weatherstrip gasketing on exterior doors and provide smoke, light, or sound gasketing on interior doors where indicated. At exterior applications provide non-corrosive fasteners and elsewhere where indicated.
- B. Smoke Labeled Gasketing: Assemblies complying with NFPA 105 that are listed and labeled by a testing and inspecting agency acceptable to authorities having jurisdiction, for smoke control ratings indicated, based on testing according to UL 1784.
 - 1. Provide smoke labeled perimeter gasketing at all smoke labeled openings.
- C. Fire Labeled Gasketing: Assemblies complying with NFPA 80 that are listed and labeled by a testing and inspecting agency acceptable to authorities having jurisdiction, for fire ratings indicated, based on testing according to UL-10C.
 - 1. Provide intumescent seals as indicated to meet UL10C Standard for Positive Pressure Fire Tests of Door Assemblies, and NPFA 252, Standard Methods of Fire Tests of Door Assemblies.
- D. Sound-Rated Gasketing: Assemblies that are listed and labeled by a testing and inspecting agency, for sound ratings indicated.
- E. Replaceable Seal Strips: Provide only those units where resilient or flexible seal strips are easily replaceable and readily available from stocks maintained by manufacturer.
- F. Manufacturers:
 - 1. Pemko (PE).
 - 2. Zero
 - 3. Reese
 - 4. National Guard

2.10 FABRICATION

- A. Fasteners: Provide door hardware manufactured to comply with published templates generally prepared for machine, wood, and sheet metal screws. Provide screws according to manufacturers recognized installation standards for application intended.

2.11 FINISHES

- A. Standard: Designations used in the Hardware Sets and elsewhere indicate hardware finishes complying with ANSI/BHMA A156.18, including coordination with traditional U.S. finishes indicated by certain manufacturers for their products.
- B. Provide quality of finish, including thickness of plating or coating (if any), composition, hardness, and other qualities complying with manufacturer's standards, but in no case less than specified by referenced standards for the applicable units of hardware
- C. Protect mechanical finishes on exposed surfaces from damage by applying a strippable, temporary protective covering before shipping.

PART 3 - EXECUTION

3.1 EXAMINATION

- A. Examine scheduled openings, with Installer present, for compliance with requirements for installation tolerances, labeled fire door assembly construction, wall and floor construction, and other conditions affecting performance.
- B. Notify architect of any discrepancies or conflicts between the door schedule, door types, drawings and scheduled hardware. Proceed only after such discrepancies or conflicts have been resolved in writing.

3.2 PREPARATION

- A. Hollow Metal Doors and Frames: Comply with ANSI/DHI A115 series.
- B. Wood Doors: Comply with ANSI/DHI A115-W series.

3.3 INSTALLATION

- A. Install each item of mechanical and electromechanical hardware and access control equipment to comply with manufacturer's written instructions and according to specifications.
 - 1. Installers are to be trained and certified by the manufacturer on the proper installation and adjustment of fire, life safety, and security products including: hanging devices; locking devices; closing devices; and seals.
- B. Mounting Heights: Mount door hardware units at heights indicated in following applicable publications, unless specifically indicated or required to comply with governing regulations:
 - 1. Standard Steel Doors and Frames: DHI's "Recommended Locations for Architectural Hardware for Standard Steel Doors and Frames."
 - 2. DHI TDH-007-20: Installation Guide for Doors and Hardware.
 - 3. Where indicated to comply with accessibility requirements, comply with ANSI A117.1 "Accessibility Guidelines for Buildings and Facilities."
 - 4. Provide blocking in drywall partitions where wall stops or other wall mounted hardware is located.

- C. Retrofitting: Install door hardware to comply with manufacturer's published templates and written instructions. Where cutting and fitting are required to install door hardware onto or into surfaces that are later to be painted or finished in another way, coordinate removal, storage, and reinstallation of surface protective trim units with finishing work specified in Division 9 Sections. Do not install surface-mounted items until finishes have been completed on substrates involved.
- D. Thresholds: Set thresholds for exterior and acoustical doors in full bed of sealant complying with requirements specified in Division 7 Section "Joint Sealants."
- E. Storage: Provide a secure lock up for hardware delivered to the project but not yet installed. Control the handling and installation of hardware items so that the completion of the work will not be delayed by hardware losses before and after installation.

3.4 ADJUSTING

- A. Initial Adjustment: Adjust and check each operating item of door hardware and each door to ensure proper operation or function of every unit. Replace units that cannot be adjusted to operate as intended. Adjust door control devices to compensate for final operation of heating and ventilating equipment and to comply with referenced accessibility requirements.

3.5 CLEANING AND PROTECTION

- A. Protect all hardware stored on construction site in a covered and dry place. Protect exposed hardware installed on doors during the construction phase. Install any and all hardware at the latest possible time frame.
- B. Clean adjacent surfaces soiled by door hardware installation.
- C. Clean operating items as necessary to restore proper finish. Provide final protection and maintain conditions that ensure door hardware is without damage or deterioration at time of owner occupancy.

3.6 DEMONSTRATION

- A. Instruct Owner's maintenance personnel to adjust, operate, and maintain mechanical and electromechanical door hardware.

3.7 DOOR HARDWARE SETS

- A. The hardware sets represent the design intent and direction of the owner and architect. They are a guideline only and should not be considered a detailed hardware schedule. Discrepancies, conflicting hardware and missing items should be brought to the attention of the architect with corrections made prior to the bidding process. Omitted items not included in a hardware set should be scheduled with the appropriate additional hardware required for proper application and functionality.
 1. Quantities listed are for each pair of doors, or for each single door.
 2. The supplier is responsible for handing and sizing all products.
 3. Where multiple options for a piece of hardware are given in a single line item, the supplier shall provide the appropriate application for the opening.

B. Manufacturer's Abbreviations:

1. MK - McKinney
2. PE - Pemko
3. RO - Rockwood
4. YA - Arrow, formerly known as Yale
6. OT - Other

Hardware Sets

Set: 1.0

Doors: 101B, 101C

3 Hinge, Full Mortise, Hvy Wt	T4A3386 (NRP and size as required)	US32D	MK
1 Storeroom or Closet Lock	TBR 8805RL (Keyed as Required)	630	YA
1 Surface Closer	UNI4400 (HD PA SPG STP Arm - EXT)	689	YA
1 Kick Plate	K1050 10" high CSK BEV	US32D	RO
1 Gasketing	303AS (Head & Jambs)		PE
1 Rain Guard	346C x Width of Frame Head		PE
1 Sweep	3452CNB x Length Required		PE
1 Threshold	175A MSES25SS x Length Required		PE

Set: 2.0

Doors: 101A

1 Hardware by Door/Frame Supplier	Hardware by Door/Frame Manufacturer	OT
-----------------------------------	-------------------------------------	----

END OF SECTION

42. Rest Area Building HVAC, Item SPV.0060.13; Maintenance Building HVAC, Item SPV.0060.17.

Add the following to section titled 1.12 Approved Manufacturers: The Following Are The Approved

Control System Manufacturers under subsection titled Part 1 General under section titled Section 23 09 24 – Direct Digital Control for HVAC:

- B. Delta Controls.
- C. Honeywell International, Inc.
- D. Johnson Controls, Inc.
- E. Schneider Electric.

F. Siemens AG, Building Technologies Division.

43. Rest Area Building Electrical, Item SPV.0060.14; Maintenance Building Electrical, Item SPV.0060.18.

*Add the following to section titled 2.1 Manufactures (b) under subsection titled **Part 2 Products** under section titled Section 26 32 13 – Engine Generators:*

5. Generac Power Systems: www.generac.com/

Plan Sheets

The following 8½ x 11-inch sheets are attached and made part of the plans for this proposal:
Revised: 77-78, 208, 213, 215-217, and 254-255.

END OF ADDENDUM

MISCELLANEOUS SCHEDULE

MARK	MATERIAL TYPE	MANUFACTURER	PROFILE	COLOR	ADDITIONAL INFORMATION	COMMENTS
DIS-1	DISPLAY CASE	REFER TO SPECS	9" W X 11 1/2" D		2" METAL FRAME / SWING GLASS DOORS WITH PINES AND 2 LOCKS ON DOOR (TOP AND BOTTOM)	
WAL-1	DIMENSION WALL COVERING	GENIUM	FLAT CUT METAL 1/2" X 1/4" X 1/4" TH	STAINLESS	STAINLESS	FINAL VERBAGE TO BE APPROVED BY CLIENT PRIOR TO MANUF.
WAL-1	METAL WALL COVERING	ASIA HARDWARE	16 X 16	BLACK	TO BE INSTALLED AT EVERY 60" O.C OR CONTRACTOR RECOMMENDATION	
HDW-2	METAL COUNTER BRACKET LOCKERS	PENCO	VANGUARD DOUBLE TIER LOCKERS / PH x 1 1/2" W x 1 1/2" D	JET BLACK	SLOPE TOPS	
TS-1	TOILET PARTITIONS	SCRANTON - HINNY HIDERS	RONDEC	CHARCOAL GREY	5TH URINAL PARTITION	DOOR FRONTS ONLY - SIDE OF STALLS ARE TILED WALLS
TS-2	METAL TRIM	SCHLUTER SYSTEMS	SOLIM LINE TRANSITIONS - SLT	BLACK	INSTALL AT ALL EXTERIOR TILE CORNERS AND EXPOSED TILE LOCATIONS	
WG-1	FLOOR TRANSITION	TARKEIT	CONTRACT ROLLER	STAINLESS	INSTALL AT ALL CRT / SC LOCATIONS	
WT-1	MANUAL ROLLER SHADE	LUTRON		E SCREEN / CHARCOAL	ADHERE ON TOP OF TILE	OFFICE WINDOWS

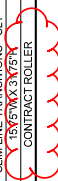

Addendum No. 02
ID 1071-07-79
Revised Sheet 77
May 9, 2024

PROJECT FINISH NOTES

- SOME SPECIFIED PRODUCTS AND FINISHES MAY HAVE SUBSTANTIAL LEAD TIMES. THE CONTRACTOR SHALL BE RESPONSIBLE FOR PLACING ORDERS IN A MANNER TO ENSURE THEIR TIMELY ARRIVAL. THE CONTRACTOR SHALL BE RESPONSIBLE FOR OBTAINING ALL NECESSARY PERMITS AND APPROVALS PRIOR TO BEGINNING WORK.
- ALL FINISH WORK SHALL BE PERFORMED IN COMPLIANCE WITH DRAWINGS AND SPECIFICATIONS. SHOP DRAWINGS, SAMPLES, AND PRODUCT DATA SHALL BE SUBMITTED TO THE ARCHITECT FOR THEIR REVIEW & APPROVAL PRIOR TO BEGINNING WORK.
- ALL WALLS TO RECEIVE PNT-1 & E-1, UNLESS NOTED OTHERWISE.
- BULKHEADS AND SOFFITS: ALL SIDES AND UNDERSIDES TO BE PAINTED THE PAINT COLOR INDICATED, UNLESS NOTED OTHERWISE.
- REFER TO REFLECTED CEILING PLANS FOR CEILING SOFFIT FINISHES AND LOCATIONS.
- PAINT ALL EXPOSED DUCTWORK, CONDUIT, ELECTRICAL EQUIPMENT, ETC. TO MATCH ADJACENT SURFACES, UNLESS NOTED OTHERWISE.
- EXTEND ALL FLOORING UNDER FURNITURE, DESKS AND COUNTERS, UNLESS NOTED OTHERWISE.
- ALL FLOORING TRANSITIONS TO BE CENTERED UNDER DOOR IN CLOSED POSITION, UNLESS NOTED OTHERWISE.
- INSTALL FLOORING PER PATTERNS REFLECTED ON FINISH PLANS. REFER TO FINISH SCHEDULE FOR ADDITIONAL NOTES.
- INSTALL DIFFERENT FLOORING TYPES PER MANUFACTURER'S RECOMMENDED METHODS, UNLESS NOTED OTHERWISE.
- FLOOR TILE AT FLOOR DRAINS TO BE INSTALLED WITH MINIMAL CUTS.
- INSTALL FIRE TREATED BLOCKING AS REQUIRED IN ALL PARTITIONS TO RECEIVE COUNTERS, SHELVING, MARKER BOARDS, TV'S, ETC.
- ALL EXPOSED ENDS OF CASEWORK TO HAVE FINISHED END PANELS.
- VERIFY GROMMET LOCATIONS WITH DESIGNER.
- IN-WALL OR WALL SUPPORT BRACKETS TO BE PAINTED TO MATCH WALL FINISH, UNLESS NOTED OTHERWISE.
- PLUMBING FIXTURES HAVE BEEN REMOVED FROM FINISH PLAN FOR VIEWING CLARITY. REFER TO THE RESPECTIVE PLANS AND DOCUMENTS FOR PLUMBING CRITERIA. ED, STAINER, SEALED AND SHOP FINISHED TO MATCH ARCHITECT'S SAMPLE WORK SHOULD BE PERFORMED IN A DUST FREE ENVIRONMENT.
- UNLESS OTHERWISE INDICATED, PROVIDE PRODUCTS OF QUALITY SPECIFIED BY AIA/AN/MAC/MI ARCHITECTURAL WOODWORK STANDARDS FOR CUSTOM GRADE.
- NOTE: REFER TO INTERIOR ELEVATIONS FOR ADDITIONAL FINISH INFORMATION.

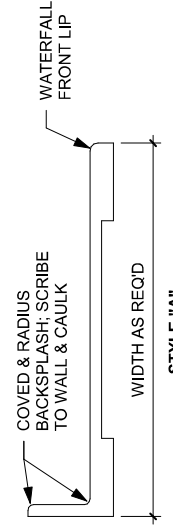
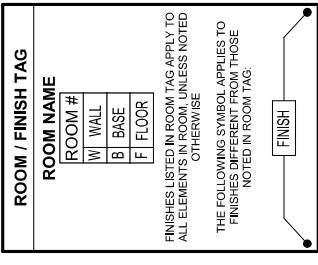
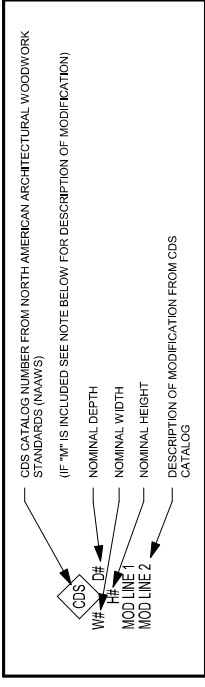

FURNITURE PLAN SHEET NOTES

- A. ALL FURNITURE SHOWN FOR REFERENCE ONLY. ALL FURNITURE TO BE PROVIDED AND INSTALLED BY OWNER UNLESS NOTED OTHERWISE. FINAL LOCATIONS AND TYPES OF FURNITURE TO BE DETERMINED BY OWNER.
- B. PROVIDE AND INSTALL BLOCKING FOR ALL EQUIPMENT AND FIXTURES.

FURNITURE SCHEDULE

MARK	MANUFACTURER	PRODUCT NAME	FINISH	ADDITIONAL INFORMATION	COMMENTS
1	ZOEFTIG	ZINARE BENCH WITH ARMS	PERFERATED METAL / SILVER ARMS AND BASE	4 SEATS / FLOOR MOUNTED	TO BE PROVIDED BY CONTRACTOR
2	ZOEFTIG	ZINARE BENCH WITH ARMS	PERFERATED METAL / SILVER ARMS AND BASE	4 SEATS / FLOOR MOUNTED	SOURCED BY CONTRACTOR

Addendum No. 02
 ID 1071-07-79
 Revised Sheet 78
 May 9, 2024

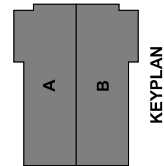
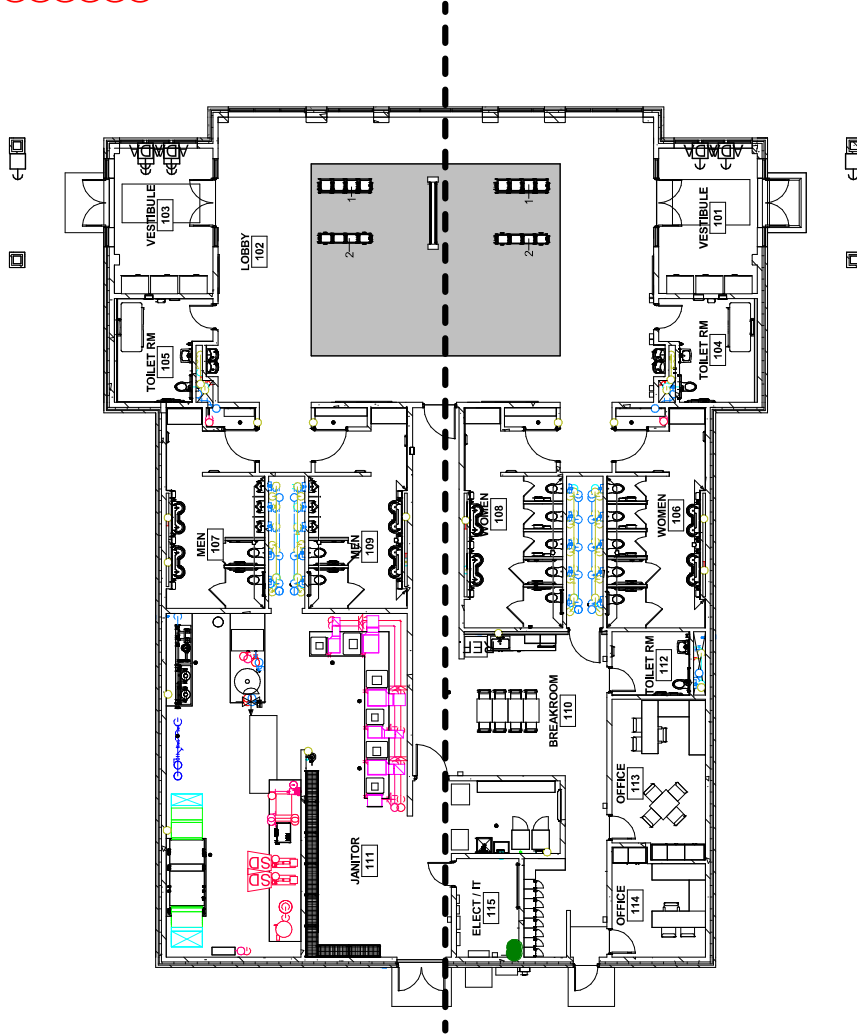

1 FURNITURE PLAN
 1/16" = 1'-0"

Branch Panel: P2

Location: Space 11
 Supply From: MDP
 Mounting: Surface
 Enclosure: Type 1

Volts: 120/208 Wye
 Phases: 3
 Wires: 4

A.I.C. Rating: 10 KAIC
 Mains Type: MCB
 Mains Rating: 200 A
 MCB Rating: 200 A

Notes:

CKT	Circuit Description	Trip	Pole	A	B	C	Pole	Trip	Circuit Description	CKT
1	RCPT - GENERATOR	20 A	1	180	500		1	20 A	MECH/BLDG CONTROL PANEL	2
3	LIGHTING	20 A	1		270	1200	1	20 A	GEN ENGINE HEATER	4
5	RCPTS - EAST WALL/EXT.	20 A	1			540	1	20 A	GARAGE DOOR	6
7	GENERATOR BATTERY...	20 A	1	1200	540		1	20 A	RCPTS - NORTH WALL	8
9	EXHAUST FAN	15 A	2		250	540	1	20 A	RCPTS - SOUTH WALL	10
11						250	1	20 A	RCPTS - SW WALL/EXTERIOR	12
13				1500	5000		1	20 A		14
15	ELECTRIC WATER HEATER (EWH-1)	20 A	3		1500	5000	3	60 A	ELECTRIC UNIT HEATER (EUH-1)	16
17						1500				18
19				5000	360		1	20 A	QUAD RCPT NEAR DATA...	20
21	ELECTRIC UNIT HEATER (EUH-2)	60 A	3		5000	0	1	20 A	SPARE	22
23							1	20 A	SPARE	24
25	BLANK	-	1	-	--		1	--	BLANK	26
27	SEWAGE EJECTOR PUMP	20 A	2		790	-	1	--	BLANK	28
29				14280 VA		790	1	--	BLANK	30
Total Load:				119 A	14488 VA	14571 VA	1	--		
Total Amps:				119 A	121 A	122 A				

Addendum No. 02
 ID 1071-07-79
 Revised Sheet 208
 May 9, 2024

Legend:

SHEET NOTES

1. WALL INFORMATION OUTLETS SHALL BE LOCATED NEXT TO POWER RECEPTACLES. COORDINATE LOCATIONS WITH ELECTRICAL CONTRACTOR PRIOR TO ROUGH-IN.
2. PROVIDE QUANTITIES AS REQUIRED BASED ON DEVICE COUNTS. REFER TO FLOOR PLANS AND SPECIFICATION FOR ADDITIONAL INFORMATION.
3. ALL ROUGH-IN BOXES AND CONDUIT SHALL BE RECESSED WHERE POSSIBLE. REFER TO ELECTRICAL PLANS AND SPECIFICATIONS FOR ADDITIONAL INFORMATION.
4. BACKGROUND MUSIC (BGM) SPEAKERS ARE SHOWN FOR GENERAL DESIGN INTENT. CONTRACTOR SHALL PROVIDE SPECIFIC MODEL, SELECTED, REFER TO PUBLIC ADDRESS SYSTEMS SPECIFICATIONS FOR ADDITIONAL INFORMATION.
5. ACCESS CONTROL SYSTEM SHALL BE ROUGH-IN & DEVICE LOCATIONS (CARD READER, DOOR CONTACT, & REQUEST TO EXIT) PRIOR TO CONSTRUCTION. REFER TO SINGLE DOOR DETAIL FOR ADDITIONAL INFORMATION.
6. COORDINATE FINAL PLACEMENT OF ALL VIDEO SURVEILLANCE CAMERA LOCATIONS WITH OWNER PRIOR TO INSTALLATION.

TECH KEYNOTE LEGEND

21	APPROXIMATE LOCATION OF WALL MOUNTED IT CABINET (SC-CAB-01) AND ASSOCIATED IT EQUIPMENT. REFER TO ELEVATION DETAIL FOR ADDITIONAL INFORMATION.
22	WALL MOUNTED (M) EYE OWNERS PROVIDED VENDING MACHINE. COORDINATE FINAL OUTLET LOCATION WITH OWNER PRIOR TO ROUGH-IN.
23	CEILING INFORMATION OUTLET (CAM) FOR INTERIOR CAMERA. COORDINATE WITH OWNER. COORDINATE FINAL OUTLET LOCATION WITH OWNER.
24	CEILING INFORMATION OUTLET (CAM) FOR INTERIOR MOUNTED SECURITY CAMERA IN VESTIBULE. COORDINATE FINAL OUTLET LOCATION WITH OWNER.
31	FUTURE ACCESS CONTROLLED DOORWAY. PROVIDE ALL USE OWNER PROVIDED CARD READER, DOOR CONTACTS & REQUEST TO EXITS. PROVIDE BLANK PLATES ON BOXES WHERE NECESSARY.
32	CEILING INFORMATION OUTLET (CAM) FOR EXTERIOR CAMERA. COORDINATE WITH OWNER. PROVIDE WEATHERPROOF EXTERIOR JUNCTION BOX AND FIRE PROOFING AS REQUIRED.
34	PROVIDE DATA CONNECTION TO LIGHTING CONTROL SYSTEM WITH PANEL PROVIDER PRIOR TO ROUGH-IN & INSTALLATION.
50	PROVIDE (Ø) 2" CONDUIT FOR INCOMING SERVICE. COORDINATE DIRECTION AND ADDITIONAL CONSTRUCTION WITH OWNER PRIOR TO CONSTRUCTION.
51	PROVIDE (Ø) 2" CONDUIT TO MAINTENANCE SHED FOR BACKBONE CABLING. COORDINATE DIRECTION AND ADDITIONAL REQUIREMENTS WITH OWNER PRIOR TO CONSTRUCTION.

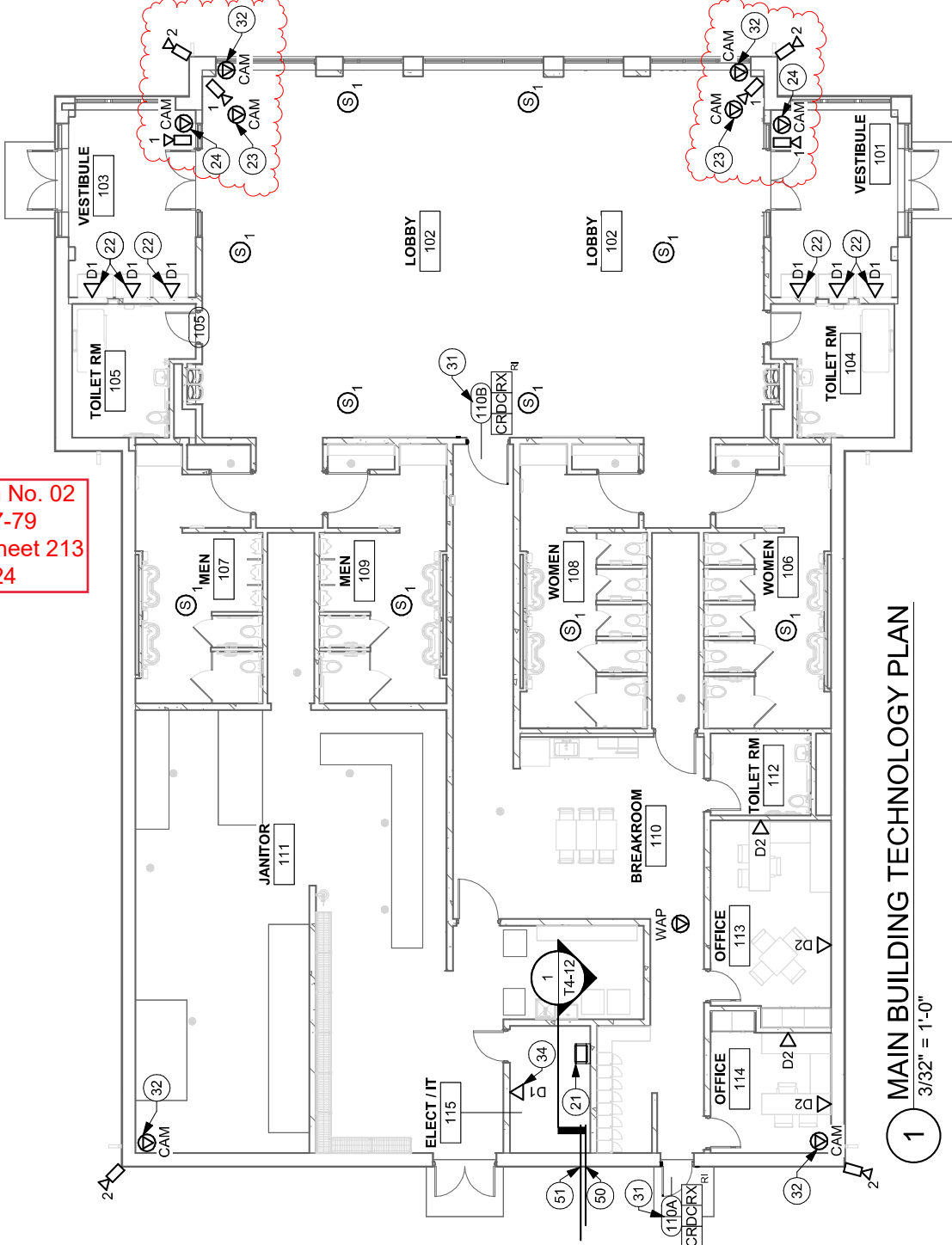

Addendum No. 02
 ID 1071-07-79
 Revised Sheet 213
 May 9, 2024

1 MAIN BUILDING TECHNOLOGY PLAN
 3/32" = 1'-0"

Addendum No. 02
ID 1071-07-79
Revised Sheet 215
May 9, 2024

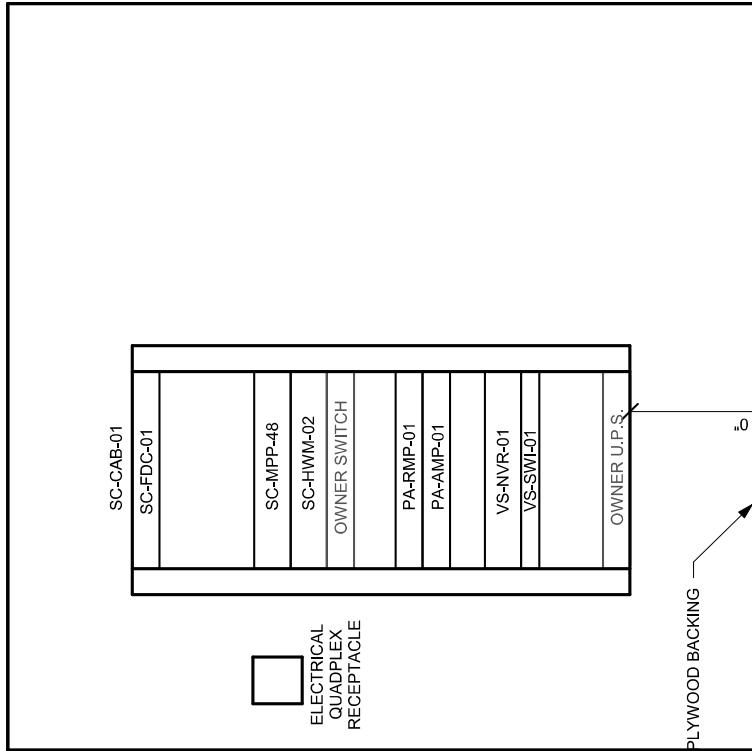

1 MDF - IT 115 - WALL MOUNTED CABINET ELEVATION
1" = 1'-0"

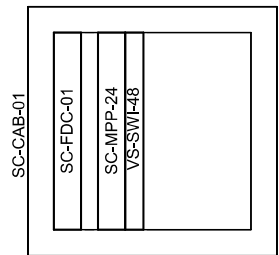

2 IDF - MAINTENANCE SHED
WALL MOUNTED CABINET ELEVATION
1" = 1'-0"

STATE PROJECT NUMBER: 1071-07-79	COUNTY: MONROE	TECHNOLOGY DETAILS	SHEET NO.: T4-12	E
HWY: IH 90	PLOT DATE: 5/7/2024 3:19:08 PM	PLOT BY: ISG ILC	PLOT SCALE: AS INDICATED	215
		PLOT NAME: RDS		

IDF MAINTENANCE 101

MDF ELECT/IT 115

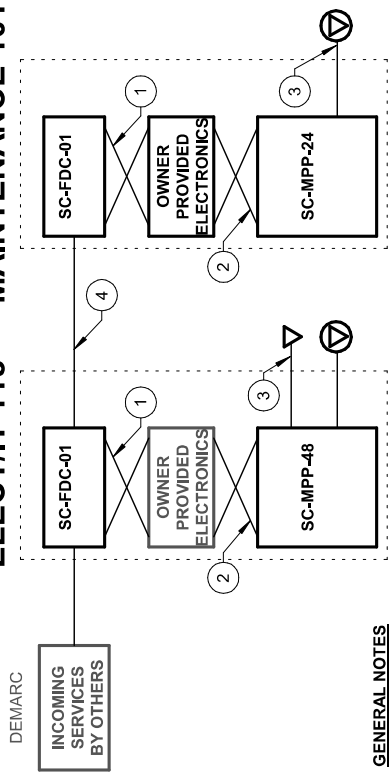

GENERAL NOTES

1. TYPICAL DEVICES SHOWN. REFER TO FLOOR PLANS FOR QUANTITIES AND LOCATIONS
2. REFER TO SPECIFICATIONS FOR ADDITIONAL INFORMATION

KEYNOTES

- 1 LC-LC FIBER PATCH CORDS BY CONTRACTOR
- 2 RJ-45 PATCH CORD BY CONTRACTOR.
- 3 CATEGORY CABLE TO DEVICES BY CONTRACTOR. REFER TO INFORMATION OUTLET CONFIGURATIONS FOR ADDITIONAL INFORMATION.
- 4 PROVIDE AT MINIMUM SINGLE-MODE OS2 12-STRAND FIBER OPTIC CABLING. PROVIDE NECESSARY EQUIPMENT FOR A FULLY FUNCTIONING SYSTEM. PROVIDE (1) 2" CONDUIT FROM MAIN IT ROOM TO MAINTENANCE SHED. COORDINATE WITH OWNER.

1 DATA RISER DIAGRAM

NOT TO SCALE

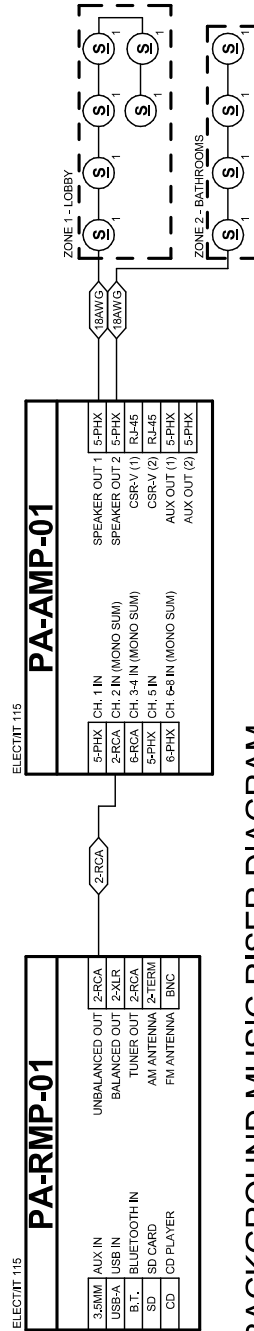

2 BACKGROUND MUSIC RISER DIAGRAM

NOT TO SCALE

Addendum No. 02
 ID 1071-07-79
 Revised Sheet 216
 May 9, 2024

CABLING TYPES	
CABLING TYPE TAG	#####
TAG	CONDUIT
18AWG	(2) 18 AWG CONDUCTORS
2-RCA	STEREO RCA CABLING

TECHNOLOGY SYMBOLS

	AC-CR-RI
	AC-DC-RI
	AC-RX-RI
	PA-SPK-01
	SC-ID-WALL
	SC-ID-CLG
	SC-CAM-01

VIDEO SURVEILLANCE SCHEDULE

DEVICE	DESCRIPTION	MODEL
VS-CAM-01	M3066 - INDOOR	AXIS M3066
VS-CAM-02	P3727 - OUTDOOR	AXIS P3727
VS-NVR-01	S3016 NVR	AXIS S3016
VS-SWI-48	VIDEO PoE SWITCH	ARUBA

ACCESS CONTROL SCHEDULE

DEVICE	DESCRIPTION	MODEL
AC-CR-RI	CARD READER, ROUGH-IN ONLY	
AC-DC-RI	DOOR CONTACT, ROUGH-IN ONLY	
AC-RX-RI	REQUEST TO EXIT, ROUGH-IN ONLY	

Addendum No. 02
ID 1071-07-79
Revised Sheet 217
May 9, 2024

INFORMATION OUTLET CONFIGURATIONS

WALL MOUNTED INFORMATION OUTLET

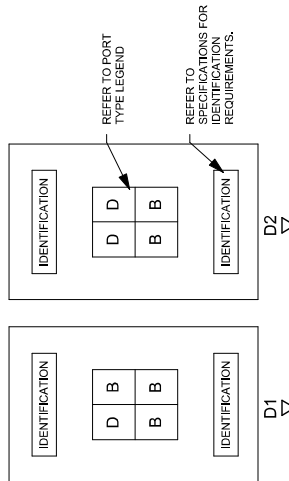

NOTES:

- PROVIDE REMOVABLE BLANK (B) INSERTS FOR ALL UNUSED PORTS.
- LOCATION OF CEILING OUTLET FOR WIRELESS ACCESS POINTS OR CAMERA. PROVIDE 15' OF SLACK LOOP COIL AT NEAREST CABLE SUPPORT FOR FUTURE RELOCATION AS REQUIRED.

CEILING SURFACE MOUNT BOX INFORMATION OUTLET

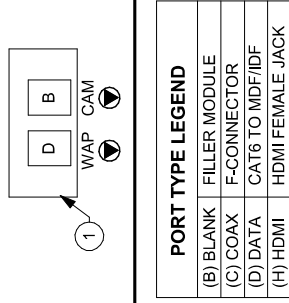

STRUCTURED CABLING SCHEDULE

DEVICE	DESCRIPTION	MODEL
SC-CAB-01	WALL MOUNTED IT CABINET - PROVIDE FAN AND FILTER KIT, ASSOCIATED HARDWARE FOR A FULLY FUNCTIONING SYSTEM	CHATSWORTH PRODUCTS 11840-748
SC-CAB-02	WALL MOUNTED IT CABINET - PROVIDE FAN AND FILTER KIT, ASSOCIATED HARDWARE FOR A FULLY FUNCTIONING SYSTEM	CHATSWORTH PRODUCTS 11900-724
SC-FDC-01	FIBER DISTRIBUTION CABINET 1RU. PROVIDE ADAPTER PANELS AS NECESSARY.	CORNING CCH-01U
SC-HWM-02	HORIZONTAL CABLE MANAGER 2 RACK UNIT, T-SHAPED CABLE GUIDES (FINGERS), SNAP-ON COVER THAT CAN BE HINGED FROM TOP OR BOTTOM.	CHATSWORTH PRODUCTS INC 13930-702
SC-ID-CLG	VARIABLES	REFER TO INFORMATION OUTLET CONFIGURATIONS FOR ADDITIONAL INFORMATION.
SC-ID-WALL	INFORMATION OUTLET - WALL	REFER TO INFORMATION OUTLET CONFIGURATIONS FOR ADDITIONAL INFORMATION.
SC-MPP-24	24-PORT MODULAR PATCH PANEL	PANDUIT CPPA24FMMWWH
SC-MPP-48	48-PORT MODULAR PATCH PANEL	PANDUIT CPPA48FMMWWH

PAGING AND BGM SCHEDULE

DEVICE	DESCRIPTION	MODEL
PA-AMP-01	2-CHANNEL RACK MOUNT AMPLIFIER AND COMMERCIAL MIXER WITH 8 TOTAL INPUTS, LOW-Z AND 70V CAPABLE.	JBL CSMA 2120
PA-RMP-01	RACK MOUNT MEDIA PLAYER WITH UNBALANCED AND BALANCED AUDIO OUTPUTS; BLUETOOTH RECEIVER, AM/FM TUNER, CD, SD AND USB INPUTS.	DENON DN-300Z
PA-SPK-01	SPEAKER - BACKGROUND MUSIC (BGM) COMPACT IN-CEILING SPEAKER, 80W LOW-Z AND 70V CAPABLE. IN ADDITION TO SPEAKER, PROVIDE ALL NECESSARY PARTS AND ACCESSORIES FOR MOUNTING TO GYPSSUM CEILING. CONTRACTOR TO VERIFY LOUD-SPEAKER CATALOG NUMBER AND INSTALLATION REQUIREMENTS PRIOR TO ORDERING. PROVIDE MANUFACTURER RECOMMENDED CABLING BASED ON POWER AND DISTANCE OF FINAL CONFIGURATION.	JBL CONTROL 24CT

SHEET NOTES

1. ALL 15A & 20A CONVENIENCE RECEPTACLES INSTALLED WITHIN PUBLIC SPACE SHALL BE TAMPER RESISTANT.
2. MAINTAIN FIRE RATING OF ALL WALLS AND FLOORS. PROVIDE FIRE PROOFING FOR ALL WALL AND FLOOR PENETRATIONS PER CODE.
3. COORDINATE WORK WITH OTHER TRADES.

ELECTRICAL KEYNOTE LEGEND

17	PROVIDE CIRCUIT TO OVERHEAD ROOF MOTOR AND MAKE CONNECTIONS TO REMOTE SWITCH AND PHOTOEYES. ALL CABLING TO BE INSTALLED WITHIN CONDUIT.
18	F&I COMBINATION MOTOR STARTER DISCONNECT FOR EXHAUST FAN. CONNECT TO GOING CONTROLLER. ACTIVATION OF CONTROLS SHALL ENERGIZE EXHAUST FAN. VERIFY COIL VOLTAGE WITH MECHANICAL PROVIDED CONTROL PANEL.
19	PROVIDE AN UNSWITCHED HOT TO MOTORIZED DAMPER FROM NEARBY AVAILABLE ELECTRICAL PANEL.
38	PROVIDE CIRCUIT TO OVERHEAD ROOF MOTOR AND MAKE CONNECTIONS TO REMOTE SWITCH AND PHOTOEYES. ALL CABLING TO BE INSTALLED WITHIN CONDUIT.
53	PROVIDE QUADRUPEX RECEPTACLE FOR WALL MOUNTED NETWORK RACK LOCATION. CONFIRM RACK LOCATION AND MOUNTING HEIGHT WITH SYSTEM INTEGRATOR.

Addendum No. 02
 ID 1071-07-79
 Revised Sheet 254
 May 9, 2024

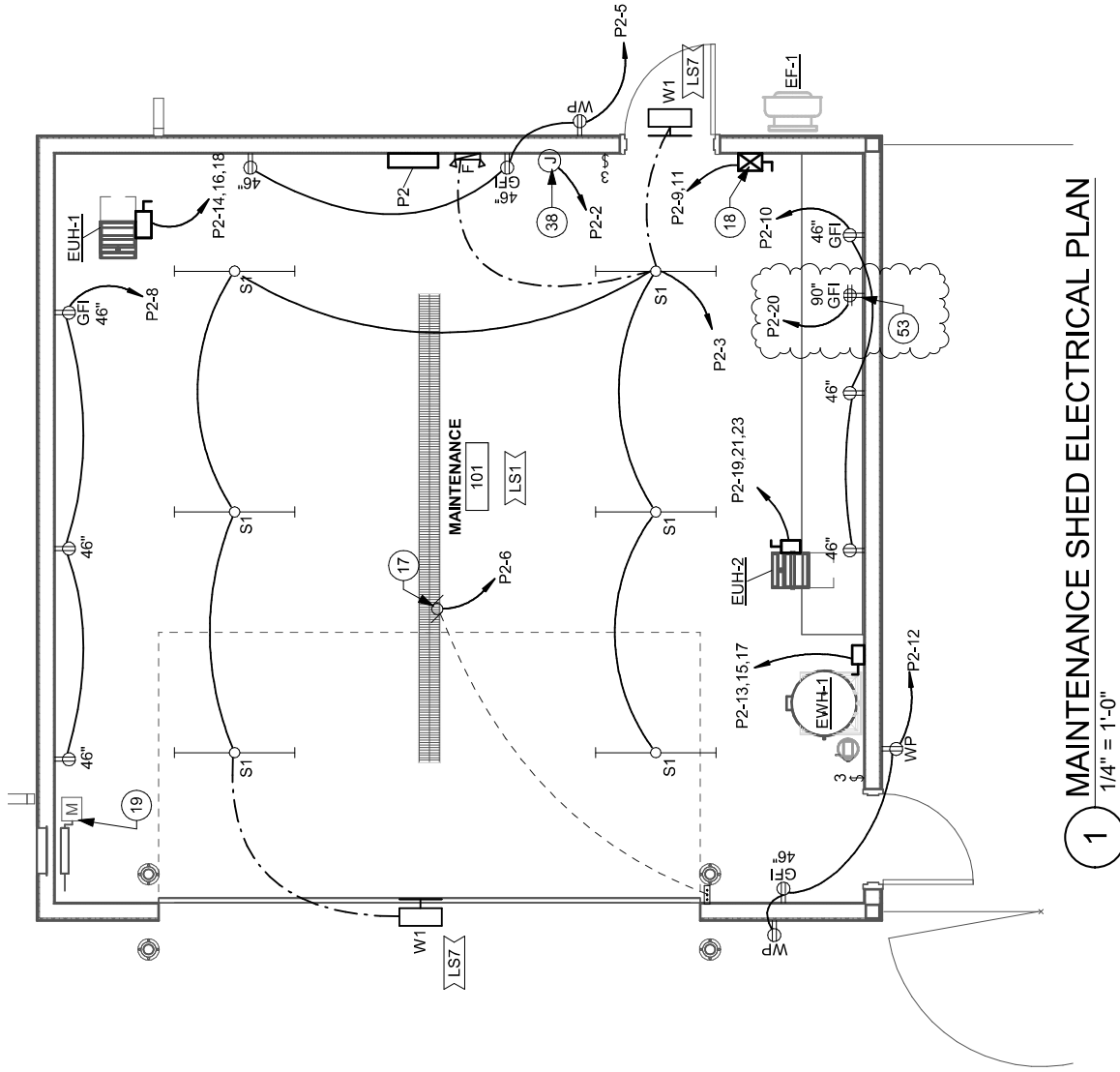

1 MAINTENANCE SHED ELECTRICAL PLAN
 1/4" = 1'-0"

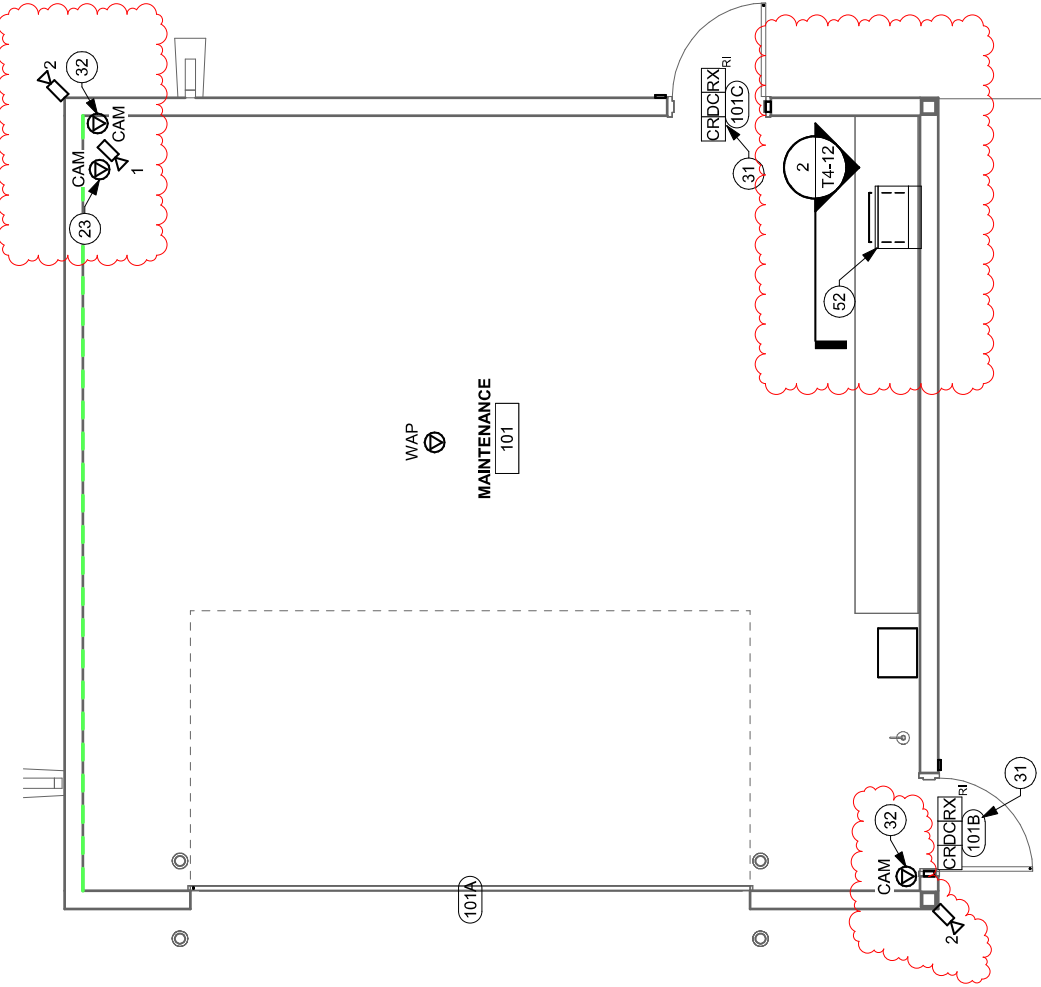

1 MAINTENANCE SHED TECHNOLOGY PLAN
1/4" = 1'-0"

- ### SHEET NOTES
1. WALL INFORMATION OUTLETS SHALL BE LOCATED NEXT TO POWER RECEPTACLES. COORDINATE LOCATIONS WITH ELECTRICAL CONTRACTOR PRIOR TO ROUGH-IN.
 2. PROVIDE QUANTITIES AS REQUIRED BASED ON DEVICE COUNTS. REFER TO FLOOR PLANS AND SPECIFICATION FOR ADDITIONAL INFORMATION.
 3. ALL ROUGH-IN SVCS AND CONDUIT SHALL BE RECESSED WHERE POSSIBLE. REFER TO ELECTRICAL PLANS AND SPECIFICATIONS FOR ADDITIONAL INFORMATION.
 4. BACKGROUND MUSIC (BGM) SPEAKERS ARE SHOWN FOR GENERAL DESIGN INTENT. CONTRACTOR SHALL PROVIDE SPEAKER SPECIFICATIONS AND MODEL. REFER TO PUBLIC ADDRESS SYSTEMS SPECIFICATIONS FOR ADDITIONAL INFORMATION.
 5. ACCESS CONTROL SYSTEM SHALL BE ROUGH-IN & COORDINATE WITH OWNER. CONTRACTOR SHALL PROVIDE LOCATIONS (CARD READER, DOOR CONTACT & REQUEST TO EXIT) PRIOR TO CONSTRUCTION. REFER TO SINGLE DOOR DETAIL FOR ADDITIONAL INFORMATION.
 6. COORDINATE FINAL PLACEMENT OF ALL VIDEO SURVEILLANCE CAMERA LOCATIONS WITH OWNER PRIOR TO INSTALLATION.

TECH KEYNOTE LEGEND

23	CEILING INFORMATION OUTLET (CAM) FOR INTERIOR MOUNTED SECURITY CAMERA. COORDINATE FINAL OUTLET LOCATION WITH OWNER.
31	FUTURE ACCESS CONTROLLED DOORWAY. PROVIDE ALL NECESSARY PATHWAYS & ROUGHINS FOR ACCESS CONTROLLED DOORWAY. REFER TO ACCESS CONTROL CONTACTS & REQUEST TO EXITS. PROVIDE BLANK PLATES ON BOXES WHERE NECESSARY. COORDINATE WITH OWNER.
32	CEILING INFORMATION OUTLET (CAM) FOR EXTERIOR MOUNTED SECURITY CAMERA. COORDINATE FINAL OUTLET LOCATION WITH OWNER. PROVIDE WEATHERPROOF EXTERIOR JUNCTION BOX AND FIRE PROOFING AS REQUIRED.
52	APPROXIMATE LOCATION OF WALL MOUNTED IT EQUIPMENT. CONTRACTOR SHALL VERIFY LOCATION FOR EQUIPMENT. REFER TO RELOCATION DETAIL FOR ADDITIONAL INFORMATION. COORDINATE FINAL LOCATION WITH OWNER AND TRADES PRIOR TO INSTALLATION.

